

Hearthstead®

Limited Asphalt Shingle Warranty

1988

CertainTeed Corporation ("CertainTeed"), subject to the conditions and limitations listed herein, warrants to the original homeowner/consumer that Hearthstead® shingles are free from actual manufacturing defects and will remain serviceable for 25 years following completion of shingle application.

CertainTeed, at its election, will repair or replace, on a non-prorated basis, any Hearthstead shingles proven to be defective during the first year following completion of the application of said shingles, up to a maximum liability which shall be equal to the reasonable replacement cost of the defective shingles, including labor, exclusive of costs of roof tear-off and of flashing and metalwork (and repairs required by defects therein).

Should any shingles prove to be defective subsequent to the first year following completion of shingle application, CertainTeed's maximum contribution toward the cost to the original homeowner/consumer of repairing or replacing said defective shingles shall be calculated using the reasonable replacement cost of the defective shingles, including labor, and by then decreasing that amount by 1/300 for each month of service measured from the date of installation of the shingles to the date when proven defective.

Shingle Applied	Warranty Period	Reduction Figure
Hearthstead® (Regular or Fungus Resistant)	25 Years (300 months)	1/300

The extent of repair or replacement required during the first year or any year subsequent to completion of shingle application, and the reasonable cost of such repair or replacement, shall be determined in the sole discretion of CertainTeed. The cost of roof tear-off is not covered by this warranty.

To obtain performance under the warranty the original homeowner/consumer shall notify CertainTeed in writing of any defect promptly following its discovery, and shall submit with such notice proof of date of purchase and application in order to provide CertainTeed an opportunity to investigate the claim and examine the material alleged to be defective. Any claimed defect for which notice is not received by CertainTeed within the 25 year warranty period is not covered by this warranty.

Notification shall be provided to CertainTeed Corporation, 1400 Union Meeting Rd., Blue Bell, Pa. 19422, Attention: Shelter Materials Group, Consumer Service Department. CertainTeed shall then promptly inspect the alleged defect and if such examination does disclose a defect covered by this warranty, shall, within a reasonable time after inspection, either repair or replace the defective shingles (if proven to be defective during the first year after completion of their application), or make the appropriate contribution toward repair or replacement in accordance with the preceding paragraphs.

Limitations

1. CertainTeed shall have no liability under this warranty for:

- Defects or failure caused by application of the shingles not in strict adherence with the instructions of CertainTeed.
- Any damage to the shingles caused by lightning, winds greater than 54 miles per hour (See Limited Wind Warranty which follows), hurricane, tornado, hailstorm, earthquake, fire, explosion, flood, solid objects falling on the roof, or any causes, except for ordinary wear and tear by the elements, not in the control of CertainTeed.
- Defects or failure of or damage caused by materials used as a roofing base over which

the shingles are applied, damage to the roof caused by settlement, distortion, failure or cracking of roof deck, walls or foundation of a building, or by traffic on the roof.

d. Damage caused by alteration after completion of the application of the shingles, whether such alteration be by structural additions, changes, or replacements, or by equipment installation (including, but not limited to, aerials, signs, water towers, fan housing, air conditioning equipment, and television antennas).

e. Damage to the roof due to any cause other than inherent manufacturing defects in the shingles.

f. Any variation in color or shading which may occur due to the positioning of the granules used as the surfacing material on these shingles.

g. If the applied shingle contains self-sealing asphalt strips, and if any of the strips fail to properly activate within the first year following the date of application of these shingles, CertainTeed shall have no liability under this warranty for such defects unless the aforementioned requirements pertaining to written notice to CertainTeed are met, and CertainTeed has been afforded the opportunity to hand seal, at its sole expense, any non-sealing shingles.

h. Fungus contamination, unless the applied shingle was sold as a fungus resistant shingle, in which event CertainTeed will repair or replace, or contribute toward the cost to the original homeowner/consumer of repairing or replacing, only such shingles which are proven to be contaminated with fungus during the warranty period; provided that the cost to CertainTeed of any such repair or replacement shall be calculated in accordance with the terms set forth herein with respect to CertainTeed's maximum contribution to the cost of repairing or replacing shingles proven to be suffering from actual manufacturing defects.

2. CertainTeed reserves the right to discontinue or modify any of its products, including the color of said shingles, without notice to the original homeowner/consumer, and shall not be liable to the original homeowner/consumer as a result of such discontinuance or modification.

3. This limited warranty gives you specific legal rights, and you may also have other rights which vary from state to state. This limited warranty is

effective on shingles applied on or subsequent to January 1, 1988. This limited warranty is not transferable. This warranty supersedes that written warranty previously issued by CertainTeed coded No. 20-20-619.

4. THIS LIMITED WARRANTY IS EXPRESSLY IN LIEU OF ANY OTHER GUARANTEES AND/OR WARRANTIES, ORAL OR WRITTEN, EXPRESSED OR IMPLIED (SUCH AS THOSE MADE BY DEALERS, CONTRACTORS, DISTRIBUTORS, OR APPLICATORS OF THE SHINGLES), EXCEPT THAT THE DURATION OF ANY IMPLIED WARRANTIES OF MERCHANTABILITY AND FITNESS FOR A PARTICULAR PURPOSE THAT THE ORIGINAL HOMEOWNER/CONSUMER MAY HAVE ARE LIMITED TO THE DURATION OF THE WRITTEN WARRANTY UNLESS A SHORTER PERIOD IS PERMITTED BY LAW. IN NO EVENT SHALL CERTAINTEED CORPORATION BE LIABLE FOR CONSEQUENTIAL OR INCIDENTAL DAMAGES OF ANY KIND, INCLUDING ANY DAMAGE TO THE BUILDING, ITS CONTENTS OR ANY PERSONS THEREIN. SOME STATES DO NOT ALLOW LIMITATIONS ON HOW LONG AN IMPLIED WARRANTY LASTS OR THE EXCLUSION OR LIMITATION OF INCIDENTAL OR CONSEQUENTIAL DAMAGES. SO THE ABOVE LIMITATIONS OR EXCLUSIONS MAY NOT APPLY TO YOU.

Limited Wind Warranty

CertainTeed warrants that its shingles will resist wind blow-off damage due to wind velocities, including "GUSTS", up to a maximum of fifty-four (54) MPH (Beaufort Scale #9) during the initial five (5) year period following application of the shingles.

If any such blow-off damage does occur during the first five (5) years of service following completion of shingle application, CertainTeed's maximum liability shall be equal to the reasonable cost of replacing blown off shingles, including labor, and the reasonable cost of manually sealing the unsealed shingles remaining on the roof. The extent of replacement and repair and the reasonable cost thereof shall be determined in the sole discretion of CertainTeed.

In the event the shingles involved contain self-sealing asphalt strips, paragraph (g) under Limitations may apply during the first year after application.

This Limited Wind Warranty is not transferable.

Any costs in excess of CertainTeed's contribution shall be the owners' responsibility through homeowner's insurance, etc.

by: Peter Jachow
President Shelter Materials Group

attest: Thomas Q. Decker
Secretary

CertainTeed

CertainTeed Corporation
Box 860, Valley Forge, PA 19482
©1988 CertainTeed Corporation

WARRANTY LIMITED

Asphalt Shingle Products

CertainTeed Corporation

P.O. Box 860, Valley Forge, PA 19482

*This warranty covers asphalt shingle products
sold only in the United States of America, its territories and Canada.*

Type of Shingle (check one)	Warranty Period	Reduction Figure	Warranty Transferable to Subsequent Owner
<input type="checkbox"/> HALLMARK SHANGLE* (Regular or Fungus Resistant)	30 YRS. (360 MOS.)	1/360	YES
<input type="checkbox"/> INDEPENDENCE SHANGLE* (Regular or Fungus Resistant)	30 YRS. (360 MOS.)	1/360	YES
<input type="checkbox"/> HORIZON SHANGLE* (Regular or Fungus Resistant)	25 YRS. (300 MOS.)	1/300	YES
<input type="checkbox"/> MASTER SLAB*	25 YRS. (300 MOS.)	1/300	NO
<input type="checkbox"/> HEARTHSTEAD* (Regular or Fungus Resistant)	25 YRS. (300 MOS.)	1/300	NO
<input type="checkbox"/> FUNGUSBUSTER* 25	25 YRS. (300 MOS.)	1/300	NO
<input type="checkbox"/> CERTAINTEED XT™ 25	25 YRS. (300 MOS.)	1/300	NO
<input type="checkbox"/> CERTAINTEED 20	20 YRS. (240 MOS.)	1/240	NO
<input type="checkbox"/> FUNGUSBUSTER*	20 YRS. (240 MOS.)	1/240	NO
<input type="checkbox"/> SEALDON* 20	20 YRS. (240 MOS.)	1/240	NO
<input type="checkbox"/> SOLID SLAB™	20 YRS. (240 MOS.)	1/240	NO
<input type="checkbox"/> CUSTOM SAF-T-LOK™	20 YRS. (240 MOS.)	1/240	NO

CertainTeed Corporation ("CertainTeed"), subject to the conditions and limitations listed herein, warrants to the original homeowner/consumer that the asphalt shingles identified herein are free from manufacturing defects and will remain serviceable for the length of time specified for the shingle applied.

5-YEAR SURESTART PROTECTION

With respect to Hallmark, Independence, Horizon, Master Slab, Hearthstead, FungusBuster 25 and CertainTeed XT 25 shingles only, CertainTeed, at its election, will repair or replace, free of charge, any shingles proven to be defective during the first five years after the completion of the application of said shingles up to a maximum liability which shall be equal to the reasonable replacement cost of the defec-

tive shingles, including labor, exclusive of costs of roof tear-off and of flashing and metal work (and repairs required by defects therein). Should any shingles prove to be defective subsequent to the first five years following completion of shingle application, CertainTeed's maximum contribution toward the cost to the homeowner/-consumer of repairing or replacing said defective shingles shall be calculated using the reasonable cost of replacement shingles, exclusive of labor, and by then decreasing that amount by 1/360 (for Hallmark and Independence) and by 1/300 (for Horizon, Master Slab, Hearthstead, FungusBuster 25 and CertainTeed XT 25) for each month of service measured from the date of installation of the shingles to the date when proven defective.

3-YEAR SURESTART PROTECTION

With respect to CertainTeed 20, FungusBuster, Sealdon 20, Solid Slab and Custom Saf-T-Lok only, CertainTeed, at its election, will repair or replace, free of charge, any shingles proven to be defective during the first three years after the completion of the application of said shingles up to a maximum liability which shall be equal to the reasonable replacement cost of the defective shingles, including labor, exclusive of costs of roof tear-off and of flashing and metal work (and repairs required by defects therein). Should any shingles prove to be defective subsequent to the first three



CertainTeed

years following completion of shingle application, CertainTeed's maximum contribution toward the cost to the homeowner/consumer of repairing or replacing said defective shingles shall be calculated using the reasonable cost of replacement shingles, exclusive of labor, and by then decreasing that amount by 1/240 for each month of service measured from the date of installation of the shingles to the date when proven defective.

NOTIFICATION

To obtain performance under the warranty, the original homeowner/consumer or subsequent owner, if applicable, shall notify CertainTeed in writing of any defect promptly following its discovery, and shall submit with such notice proof of date of purchase and application in order to provide CertainTeed an opportunity to investigate the claim and examine the material alleged to be defective. Any claimed defect for which notice is not received by CertainTeed within the applicable warranty period is not covered by this warranty.

Notification shall be provided to CertainTeed Corporation, 1400 Union Meeting Rd., Blue Bell, Pa. 19422, Attention: Shelter Materials Group, Consumer Service Department. CertainTeed shall then promptly inspect the alleged defect and if such examination does disclose a defect covered by this warranty, shall, within a reasonable time after inspection, either repair or replace the defective shingles or make the appropriate contribution toward repair or replacement in accordance with the preceding paragraphs.

TRANSFERABILITY

This limited warranty may only be transferred to a subsequent owner of the building if either Hallmark Shingle®, Independence Shingle®, or Horizon Shingle® were applied. Transfer of this warranty shall not renew or extend the warranty term, nor alter the warranty provisions. The subsequent owner shall be deemed the holder of this warranty and shall have the same rights and duties as the original homeowner/consumer.

LIMITATIONS

1. CertainTeed shall have no liability under this warranty for:
 - a. Defects or failure caused by application of the shingles not in strict adherence with the instructions of CertainTeed.
 - b. Any damage to the shingles caused by lightning, winds greater than 54 miles per hour (SEE Limited Wind Warranty which follows), hurricane, tornado, hailstorm, earthquake, fire, explosion, flood, solid objects falling on the roof, or any causes, except for

ordinary wear and tear by the elements, not in the control of CertainTeed.

c. Defects or failure of or damage caused by materials used as a roofing base over which the shingles are applied, damage to the roof caused by settlement, distortion, failure or cracking of roof deck, walls or foundation of a building, or by traffic on the roof.

d. Damage caused by alteration after completion of the application of the shingles, whether such alteration be by structural additions, changes, or replacements, or by equipment installation (including, but not limited to, aerials, signs, water towers, fan housing, air conditioning equipment, and television antennas).

e. Damage to the roof due to any cause other than inherent manufacturing defects in the shingles.

f. Any variation in color or shading which may occur due to the positioning of the granules used as the surfacing material on these shingles.

g. If the applied shingle contains self-sealing asphalt strips, and if any of the strips fail to properly activate within the first year following the date of application of these shingles, CertainTeed shall have no liability under this warranty for such defects unless the aforesaid requirements pertaining to written notice to CertainTeed are met, and CertainTeed has been afforded the opportunity to hand seal, at its sole expense, any non-sealing shingles.

h. Fungus contamination, unless the applied shingle was sold as a fungus resistant shingle, in which event CertainTeed will repair or replace only such shingles which are proven to be contaminated with fungus or make the appropriate contribution toward repair or replacement of any such shingles in accordance with the preceding paragraphs.

2. CertainTeed reserves the right to discontinue or modify any of its products, including the color of said shingles, without notice to the original homeowner/consumer or a subsequent owner and shall not be liable to the original homeowner/consumer or a subsequent owner as a result of such discontinuance or modification.
3. This limited warranty gives you specific legal rights, and you may also have other rights which vary from state to state. This limited warranty is effective on shingles applied on or after January 1, 1989. This limited warranty is not transferable except as provided in the preceding section entitled "Transferability." This warranty supersedes those written warranties previously issued by

CertainTeed coded No. 20-20-716 and 20-20-717.

4. This limited warranty is expressly in lieu of any other guarantees and/or warranties, oral or written, expressed or implied (such as those made by dealers, contractors, distributors or applicators of the shingles), except that the duration of any implied warranties of merchantability and fitness for a particular purpose that the original homeowner/consumer may have are limited to the duration of the written warranty unless a shorter period is permitted by law. In no event shall CertainTeed Corporation be liable for consequential or incidental damages of any kind, including any damage to the building, its contents or any persons therein. Some states do not allow limitation on how long an implied warranty lasts or the exclusion or limitation of incidental or consequential damages, so the above limitations or exclusions may not apply to you.



LIMITED WIND WARRANTY

CertainTeed warrants that its shingles will resist wind blow-off damage due to wind velocities, including "GUSTS," up to a maximum of fifty-four (54) MPH (Beaufort Scale #9) during the initial five (5) year period following application of the shingles.

If any such blow-off damage does occur during the first five (5) years of service from the completion date of application of the shingles, CertainTeed will furnish replacement shingles without charge for those shingles damaged. Our five (5) year Limited Wind Warranty does not cover the labor costs for removal of damaged shingles or application of the replacement shingles. In the event the shingles involved contain self-sealing asphalt strips, paragraph (g) under Limitations set forth above may apply during the first year after application. This Limited Wind Warranty is non-transferable unless the type of shingles applied were Hallmark Shingle®, Independence Shingle®, or Horizon Shingle®.

Any costs in excess of CertainTeed's contribution shall be the owners' responsibility through homeowner's insurance, etc.

by: Pete Jacobson
President, Shelter Materials Group

attest: Thomas Q. Pader
Secretary

CertainTeed Corporation
Roofing Products Group
P.O. Box 860
Valley Forge, PA 19482
800-345-1145

WARRANTY LIMITED



Asphalt Shingle Products

CertainTeed Corporation

Type of Shingle (check one)	Warranty Period	Reduction Figure	Warranty Transferable to Subsequent Owner
<input type="checkbox"/> HALLMARK SHANGLE*	30 YRS. (360 MOS.)	1/360	YES
<input type="checkbox"/> INDEPENDENCE SHANGLE*	30 YRS. (360 MOS.)	1/360	YES
<input type="checkbox"/> HORIZON SHANGLE* <small>Regular or Fungus Resistant</small>	25 YRS. (300 MOS.)	1/300	YES
<input type="checkbox"/> MASTER SLAB*	25 YRS. (300 MOS.)	1/300	NO
<input type="checkbox"/> HEARTHSTEAD*	25 YRS. (300 MOS.)	1/300	NO
<input type="checkbox"/> CERTAINTEED XT™ 25	25 YRS. (300 MOS.)	1/300	NO
<input type="checkbox"/> CERTAINTEED 20	20 YRS. (240 MOS.)	1/240	NO
<input type="checkbox"/> FUNGUSBUSTER*	20 YRS. (240 MOS.)	1/240	NO
<input type="checkbox"/> SEALDON* 20	20 YRS. (240 MOS.)	1/240	NO
<input type="checkbox"/> SOLID SLAB™	20 YRS. (240 MOS.)	1/240	NO
<input type="checkbox"/> CUSTOM SAF-T-LOK™	20 YRS. (240 MOS.)	1/240	NO

CertainTeed Corporation ("CertainTeed"), subject to the conditions and limitations set forth herein, warrants to the original homeowner/consumer that the asphalt shingles identified herein are free from manufacturing defects and will remain serviceable for the length of time specified for the shingle applied.

5-YEAR SURESTART™ PROTECTION

With respect to Hallmark, Independence, Horizon, Master Slab, Hearthstead and CertainTeed XT 25 shingles only, CertainTeed, at its election, will repair or replace, free of charge, any shingles proven to be defective during the first five years after the completion of the application of said shingles up to a maximum liability which shall be equal to the rea-

sonable replacement cost of the defective shingles, including labor, exclusive of costs of roof tear-off and of flashing and metal work (and repairs required by defects therein). Should any shingles prove to be defective subsequent to the first five years following completion of shingle application, CertainTeed's maximum contribution toward the cost to the homeowner/consumer of repairing or replacing said defective shingles shall be calculated using the reasonable cost of replacement shingles, exclusive of labor, and by then decreasing that amount by 1/360 (for Hallmark and Independence) and by 1/300 (for Horizon, Master Slab, Hearthstead and CertainTeed XT 25) for each month of service measured from the date of installation of the shingles to the date when proven defective.

3-YEAR SURESTART™ PROTECTION

With respect to CertainTeed 20, Fungus-Buster, Sealdon 20, Solid Slab and Custom Saf-T-Lok only, CertainTeed, at its election, will repair or replace, free of charge, any shingles proven to be defective during the first three years after the completion of the application of said shingles up to a maximum liability which shall be equal to the reasonable replacement cost of the defective shingles, including labor, exclusive of costs of roof tear-off and of flashing and metal work (and repairs required by defects therein). Should any shingles prove to be defective subsequent to the first three



(Please Refer to Reverse Side for Remainder of Warranty, Including Limitations)

years following completion of shingle application. CertainTeed's maximum contribution toward the cost to the homeowner/consumer of repairing or replacing said defective shingles shall be calculated using the reasonable cost of replacement shingles, exclusive of labor, and by then decreasing that amount by 1/240 for each month of service measured from the date of installation of the shingles to the date when proven defective.

In the event of repair or replacement pursuant to the terms of this warranty, the warranty on the replacement shingles or on the repaired shingles will extend for the balance of the original warranty period.

NOTIFICATION

To obtain performance under the warranty, the original homeowner/consumer or subsequent owner, if applicable, shall notify CertainTeed in writing of any defect promptly following its discovery, and shall submit with such notice proof of date of purchase and application in order to provide CertainTeed an opportunity to investigate the claim and examine the material alleged to be defective. Any claimed defect for which notice is not received by CertainTeed within the applicable warranty period is not covered by this warranty.

Notification shall be provided to CertainTeed Corporation, 1400 Union Meeting Rd., Blue Bell, Pa. 19422, Attention: Shelter Materials Group, Consumer Service Department. CertainTeed shall then promptly inspect the alleged defect and if such examination does disclose a defect covered by this warranty, shall, within a reasonable time after inspection, either repair or replace the defective shingles or make the appropriate contribution toward repair or replacement in accordance with the preceding paragraphs.

TRANSFERABILITY

This limited warranty may only be transferred to a subsequent owner of the building if either Hallmark Shangle®, Independence Shangle® or Horizon Shangle® were applied, and furthermore may only be transferred during the period of the SureStart Protection (five years) offered herein for the shingle applied as measured from the date of installation of the shingles. In the event that this warranty is effectively transferred, the warranty provisions shall not be altered and the subsequent owner shall be deemed the holder of this warranty and shall have the same rights and duties as the original homeowner/consumer.

This warranty is transferable to a new owner of the premises provided CertainTeed is notified in writing (at the address set forth in the preceding paragraph) by the new owner within 45 days of the real estate title transfer.

LIMITATIONS

1. CertainTeed shall have no liability under this warranty for:
 - a. Defects or failure caused by application of the shingles not in strict adherence with the written instructions of CertainTeed.
 - b. Any damage to the shingles caused by

lightning, winds greater than 54 miles per hour (SEE Limited Wind Warranty which follows), hurricane, tornado, hailstorm, earthquake, fire, explosion, flood, solid objects falling on the roof, or any causes, except for ordinary wear and tear by the elements, not in the control of CertainTeed.

c. Defects or damage caused by materials used as a roofing base over which the shingles are applied, damage to the roof caused by settlement, distortion, failure or cracking of the roof deck, walls or foundation of a building, or by traffic on the roof.

d. Damage caused by alteration after completion of the application of the shingles, whether such alteration be by structural additions, changes, or replacements, or by equipment installation (including, but not limited to, aerials, signs, water towers, fan housing, air conditioning equipment, and television antennas).

e. Damage to the roof due to any cause other than inherent manufacturing defects in the shingles.

f. Any variation in color or shading which may occur due to the positioning of the granules used as the surfacing material on these shingles.

g. If the applied shingle contains self-sealing asphalt strips, and if any of the strips fail to properly activate within the first year following the date of application of these shingles, CertainTeed shall have no liability under this warranty for such defects unless the aforesaid requirements pertaining to written notice to CertainTeed are met, and CertainTeed has been afforded the opportunity to hand seal, at its sole expense, any non-sealing shingles.

h. Fungus contamination, unless the applied shingle was sold as a fungus resistant shingle, in which event CertainTeed will repair or replace only such shingles which are proven to be contaminated with fungus or make the appropriate contribution toward repair or replacement of any such shingles in accordance with the preceding paragraphs.

2. CertainTeed reserves the right to discontinue or modify any of its products, including the color of said shingles, without notice to the original homeowner/consumer or a subsequent owner and shall not be liable to the original homeowner/consumer or a subsequent owner as a result of such discontinuance or modification, nor shall CertainTeed be liable in the event replacement material may vary in color in comparison to the original product as a result of normal weathering. If CertainTeed replaces any material under this warranty, it may substitute products designated by CertainTeed to be of comparable quality or price range in the event the product initially installed has been discontinued or modified.

OTHER CONDITIONS

1. This limited warranty gives you specific legal rights, and you may also have other rights which vary from state to state.

2. This limited warranty is not transferable except as provided in the preceding section entitled "Transferability."
3. This limited warranty, which is effective on shingles applied on or after January 1, 1990, supersedes that written warranty previously issued by CertainTeed coded No. 20-20-874.
4. This warranty is expressly in lieu of all other oral or written warranties, liabilities or obligations of CertainTeed. Pertinent state law shall control for what period of time subsequent to sale a consumer/homeowner may seek a remedy pursuant to the implied warranty of merchantability or of fitness for a particular purpose. In no event shall CertainTeed be liable for consequential or incidental damages of any kind, including any damage to the building, its contents or any persons therein, resulting from the breach of any warranty set forth herein. No representative of CertainTeed or its distributors or dealers is authorized to make any change or modifications to this warranty. Some states do not allow limitations on the exclusion of incidental or consequential damages, so the above exclusions may not apply to you.



LIMITED WIND WARRANTY

CertainTeed warrants that its shingles will resist wind blow-off damage due to wind velocities, including "GUSTS," up to a maximum of fifty-four (54) MPH (Beaufort Scale #9) during the initial five (5) year period following application of the shingles.

If any such blow-off damage does occur during the first five (5) years of service from the completion date of application of the shingles, CertainTeed will furnish replacement shingles without charge for those shingles damaged. This five (5) year Limited Wind Warranty does not cover the labor costs for removal of damaged shingles or application of the replacement shingles. In the event the shingles involved contain self-sealing asphalt strips, paragraph (g) under Limitations set forth above may apply during the first year after application. This Limited Wind Warranty is non-transferable unless the type of shingles applied were Hallmark Shangle®, Independence Shangle®, or Horizon Shangle®.

Any costs in excess of CertainTeed's contribution shall be the owners' responsibility through homeowner's insurance, etc.

CertainTeed Corporation
P.O. Box 860
Valley Forge, PA 19482

WARRANTY LIMITED



Asphalt Shingle Products

CertainTeed Corporation

Type of Shingle (check one)	Warranty Period	Reduction Figure	Warranty Transferable to Subsequent Owner
<input type="checkbox"/> HALLMARK SHANGLE®	30 YRS. (360 MOS.)	1/360	YES*
<input type="checkbox"/> INDEPENDENCE SHANGLE®	30 YRS. (360 MOS.)	1/360	YES*
<input type="checkbox"/> HORIZON SHANGLE® <small>Regular or Fungus Resistant</small>	25 YRS. (300 MOS.)	1/300	YES*
<input type="checkbox"/> MASTER SLAB®	25 YRS. (300 MOS.)	1/300	NO
<input type="checkbox"/> HEARTHSTEAD®	25 YRS. (300 MOS.)	1/300	NO
<input type="checkbox"/> CUSTOM SEALDON™	25 YRS. (300 MOS.)	1/300	NO
<input type="checkbox"/> CERTAINTEED XT™ 25	25 YRS. (300 MOS.)	1/300	NO
<input type="checkbox"/> CERTAINTEED 20	20 YRS. (240 MOS.)	1/240	NO
<input type="checkbox"/> FUNGUSBUSTER®	20 YRS. (240 MOS.)	1/240	NO
<input type="checkbox"/> SEALDON® 20	20 YRS. (240 MOS.)	1/240	NO
<input type="checkbox"/> SOLID SLAB™	20 YRS. (240 MOS.)	1/240	NO
<input type="checkbox"/> SAF-T-LOK™	20 YRS. (240 MOS.)	1/240	NO

*During SureStart period only

CertainTeed Corporation ("CertainTeed"), subject to the conditions and limitations set forth herein, warrants to the original homeowner/consumer that the asphalt shingles identified herein are free from manufacturing defects and will remain serviceable for the length of time specified for the shingle applied.

5-YEAR SURESTART™ PROTECTION

With respect to Hallmark, Independence, Horizon, Master Slab, Hearthstead, Custom Sealdon and XT 25 shingles only, CertainTeed, at its election, will repair or replace, free of charge, any shingles proven to be defective during the first five years after the completion of the application of said shingles up to a maximum liability which shall be equal to the reasonable replacement cost of the defective

shingles, including labor, exclusive of costs of roof tear-off and disposal and of flashing and metal work (and repairs required by defects therein). Should any shingles prove to be defective subsequent to the first five years following completion of shingle application, CertainTeed's maximum contribution toward the cost to the homeowner/consumer of repairing or replacing said defective shingles shall be calculated using the reasonable cost of replacement shingles, exclusive of labor, roof tear-off and disposal, and by then decreasing that amount by 1/360 (for Hallmark and Independence) and by 1/300 (for Horizon, Master Slab, Custom Sealdon, Hearthstead and XT 25) for each month of service measured from the date of installation of the shingles to the date when proven defective.

3-YEAR SURESTART™ PROTECTION

With respect to CertainTeed 20, Fungus-Buster, Sealdon 20, Solid Slab and Saf-T-Lok only, CertainTeed, at its election, will repair or replace, free of charge, any shingles proven to be defective during the first three years after the completion of the application of said shingles up to a maximum liability which shall be equal to the reasonable replacement cost of the defective shingles, including labor, exclusive of costs of roof tear-off and disposal and of flashing and metal work (and repairs required by defects therein). Should any shingles prove to be defective subsequent to the first three



(Please Refer to Reverse Side for Remainder of Warranty, Including Limitations)

years following completion of shingle application, CertainTeed's maximum contribution toward the cost to the homeowner/consumer of repairing or replacing said defective shingles shall be calculated using the reasonable cost of replacement shingles, exclusive of labor, roof tear-off and disposal, and by then decreasing that amount by 1/240 for each month of service measured from the date of installation of the shingles to the date when proven defective.

In the event of repair or replacement pursuant to the terms of this warranty, the warranty on the replacement shingles or on the repaired shingles will extend for the balance of the original warranty period.

NOTIFICATION

To obtain performance under the warranty, the original homeowner/consumer or subsequent owner, if applicable, shall notify CertainTeed in writing of any defect promptly following its discovery, and shall submit with such notice proof of date of purchase and application in order to provide CertainTeed an opportunity to investigate the claim and examine the material alleged to be defective. Any claimed defect for which notice is not received by CertainTeed within the applicable warranty period is not covered by this warranty.

Notification shall be provided to CertainTeed Corporation, 1400 Union Meeting Rd., Blue Bell, Pa. 19422, Attention: Shelter Materials Group, Consumer Service Department. CertainTeed shall then promptly inspect the alleged defect and if such examination does disclose a defect covered by this warranty, shall, within a reasonable time after inspection, either repair or replace the defective shingles or make the appropriate contribution toward repair or replacement in accordance with the preceding paragraphs.

TRANSFERABILITY

This limited warranty may only be transferred to a subsequent owner of the building if either Hallmark Shingle®, Independence Shingle® or Horizon Shingle® was applied, and furthermore may only be transferred during the period of the SureStart Protection (five years) offered herein for the shingle applied as measured from the date of installation of the shingles. In the event that this warranty is effectively transferred, the warranty provisions shall not be altered and the subsequent owner shall be deemed the holder of this warranty and shall have the same rights and duties as the original homeowner/consumer.

This warranty is transferable to a new owner of the premises provided CertainTeed is notified in writing (at the address set forth in the preceding section entitled "Notification") by the new owner within 45 days of the real estate title transfer.

LIMITATIONS

1. CertainTeed shall have no liability under this warranty for:
 - a. Defects or failure caused by application of the shingles not in strict adherence with the written instructions of CertainTeed.

b. Any damage to the shingles caused by lightning, winds greater than 54 miles per hour (See Limited Wind Warranty which follows), hurricane, tornado, hailstorm, earthquake, fire, explosion, flood, solid objects falling on the roof, or any causes, except for ordinary wear and tear by the elements, not in the control of CertainTeed.

c. Defects or damage caused by materials used as a roofing base over which the shingles are applied, damage to the roof caused by settlement, distortion, failure or cracking of the roof deck, walls or foundation of a building, or by traffic on the roof.

d. Damage caused by alteration after completion of the application of the shingles, whether such alteration be by structural additions, changes, or replacements, or by equipment installation (including, but not limited to, aerials, signs, water towers, fan housing, air conditioning equipment, and television antennas).

e. Damage to the roof due to any cause other than inherent manufacturing defects in the shingles.

f. Any variation in color or shading which may occur due to the positioning of the granules used as the surfacing material on the shingles.

g. If the applied shingle contains self-sealing asphalt strips, and if any of the strips fail to properly activate within the first year following the date of application of these shingles, CertainTeed shall have no liability under this warranty for such defects unless the aforesaid requirements pertaining to written notice to CertainTeed are met, and CertainTeed has been afforded the opportunity to hand seal, at its sole expense, any non-sealing shingles.

h. Fungus contamination, unless the applied shingle was sold as a fungus resistant shingle, in which event CertainTeed will repair or replace only such shingles which are proven to be contaminated with fungus or make the appropriate contribution toward repair or replacement of any such shingles in accordance with the preceding paragraphs.

2. CertainTeed reserves the right to discontinue or modify any of its products, including the color of said shingles, without notice to the original homeowner/consumer or a subsequent owner and shall not be liable to the original homeowner/consumer or a subsequent owner as a result of such discontinuance or modification, nor shall CertainTeed be liable in the event replacement material may vary in color in comparison to the original product as a result of normal weathering. If CertainTeed replaces any material under this warranty, it may substitute products designated by CertainTeed to be of comparable quality or price range in the event the product initially installed has been discontinued or modified.

OTHER CONDITIONS

1. This limited warranty gives you specific legal rights, and you may also have other rights which vary from state to state.

2. This limited warranty is not transferable except as provided in the preceding section entitled "Transferability".
3. This limited warranty, which is effective on shingles applied on or after January 1, 1991, supersedes that written warranty previously issued by CertainTeed coded No. 20-20-066.
4. THIS WARRANTY IS EXPRESSLY IN LIEU OF ALL OTHER ORAL OR WRITTEN WARRANTIES, LIABILITIES OR OBLIGATIONS OF CERTAINTEED. PERTINENT STATE LAW SHALL CONTROL FOR WHAT PERIOD OF TIME SUBSEQUENT TO SALE A CONSUMER/HOMEOWNER MAY SEEK A REMEDY PURSUANT TO THE IMPLIED WARRANTY OF MERCHANTABILITY OR OF FITNESS FOR A PARTICULAR PURPOSE. IN NO EVENT SHALL CERTAINTEED BE LIABLE FOR CONSEQUENTIAL OR INCIDENTAL DAMAGES OF ANY KIND, INCLUDING ANY DAMAGE TO THE BUILDING, ITS CONTENTS OR ANY PERSONS THEREIN, RESULTING FROM THE BREACH OF ANY WARRANTY SET FORTH HEREIN. NO REPRESENTATIVE OF CERTAINTEED OR ITS DISTRIBUTORS OR DEALERS IS AUTHORIZED TO MAKE ANY CHANGE OR MODIFICATIONS TO THIS WARRANTY. Some states do not allow limitations or the exclusion of incidental or consequential damages, so the above exclusions may not apply to you.



LIMITED WIND WARRANTY

CertainTeed warrants that its shingles will resist wind blow-off damage due to wind velocities, including "GUSTS", up to a maximum of fifty-four (54) MPH (Beaufort Scale #9) during the initial five (5) year period following application of the shingles.

If any such blow-off damage does occur during the first five (5) years of service from the completion date of application of the shingles, CertainTeed will furnish replacement shingles without charge for those shingles damaged (subject to the provisions of paragraph 2 under Limitations set forth above). This five (5) year Limited Wind Warranty does not cover the labor costs for removal or disposal of damaged shingles or application of the replacement shingles. In the event the shingles involved contain self-sealing asphalt strips, paragraph 1(g) under Limitations set forth above may apply during the first year after application. This Limited Wind Warranty is non-transferable unless the type of shingles applied were Hallmark Shingle®, Independence Shingle®, or Horizon Shingle®.

Any costs in excess of CertainTeed's contribution shall be the owners' responsibility through homeowner's insurance, etc.

CertainTeed Corporation
P.O. Box 860
Valley Forge, PA 19482

WARRANTY LIMITED

1992



Asphalt Shingle Products

CertainTeed Corporation

P.O. Box 860
Valley Forge, PA 19482

Type of Shingle (check one)	Warranty Period	Reduction Figure	Warranty Transferable to Subsequent Owner
<input type="checkbox"/> HALLMARK SHANGLE®	30 YRS. (360 MOS.)	1/360	YES*
<input type="checkbox"/> INDEPENDENCE SHANGLE®	30 YRS. (360 MOS.)	1/360	YES*
<input type="checkbox"/> HORIZON SHANGLE® <small>Regular or Fungus Resistant</small>	25 YRS. (300 MOS.)	1/300	YES*
<input type="checkbox"/> HEARTHSTEAD®	25 YRS. (300 MOS.)	1/300	NO
<input type="checkbox"/> CUSTOM SEALDON™	25 YRS. (300 MOS.)	1/300	NO
<input type="checkbox"/> MASTER SLAB®	25 YRS. (300 MOS.)	1/300	NO
<input type="checkbox"/> CERTAINTEED XT™ 25	25 YRS. (300 MOS.)	1/300	NO
<input type="checkbox"/> CERTAINTEED 20	20 YRS. (240 MOS.)	1/240	NO
<input type="checkbox"/> FUNGUSBUSTER®	20 YRS. (240 MOS.)	1/240	NO
<input type="checkbox"/> SEALDON® 20	20 YRS. (240 MOS.)	1/240	NO
<input type="checkbox"/> SOLID SLAB™	20 YRS. (240 MOS.)	1/240	NO
<input type="checkbox"/> SAF-T-LOK™	20 YRS. (240 MOS.)	1/240	NO

*During SureStart period only

CertainTeed Corporation ("CertainTeed"), subject to the conditions and limitations set forth herein, warrants to the original homeowner/consumer that the asphalt shingles identified herein are free from manufacturing defects and will remain serviceable for the length of time specified for the shingle applied.

5-YEAR SURESTART™ PROTECTION

With respect to Hallmark, Independence, Horizon, Hearthstead, Custom Sealdon, Master Slab and XT 25 shingles only, CertainTeed, at its election, will repair or replace, free of charge, any shingles proven to be defective during the first five years after the completion of the application of said shingles up to a maximum liability which shall be equal to the reasonable replacement cost of the defective

shingles, including labor, exclusive of costs of roof tear-off and disposal and of flashing and metal work (and repairs required by defects therein). Should any shingles prove to be defective subsequent to the first five years following completion of shingle application, CertainTeed's maximum contribution toward the cost to the homeowner/consumer of repairing or replacing said defective shingles shall be calculated using the reasonable cost of replacement shingles, exclusive of labor, roof tear-off and disposal, and by then decreasing that amount by 1/360 (for Hallmark and Independence) and by 1/300 (for Horizon, Hearthstead, Custom Sealdon, Master Slab and XT 25) for each month of service measured from the date of installation of the shingles to the date when proven defective.

3-YEAR SURESTART™ PROTECTION

With respect to CertainTeed 20, Fungus-Buster, Sealdon 20, Solid Slab and Saf-T-Lok only, CertainTeed, at its election, will repair or replace, free of charge, any shingles proven to be defective during the first three years after the completion of the application of said shingles up to a maximum liability which shall be equal to the reasonable replacement cost of the defective shingles, including labor, exclusive of costs of roof tear-off and disposal and of flashing and metal work (and repairs required by defects therein). Should any shingles prove to be defective subsequent to the first three



(Please Refer to Reverse Side for Remainder of Warranty, Including Limitations)

years following completion of shingle application, CertainTeed's maximum contribution toward the cost to the homeowner/consumer of repairing or replacing said defective shingles shall be calculated using the reasonable cost of replacement shingles, exclusive of labor, roof tear-off and disposal, and by then decreasing that amount by 1/240 for each month of service measured from the date of installation of the shingles to the date when proven defective.

In the event of repair or replacement pursuant to the terms of this warranty, the warranty on the replacement shingles or on the repaired shingles will extend for the balance of the original warranty period.

NOTIFICATION

To obtain performance under the warranty, the original homeowner/consumer or subsequent owner, if applicable, shall notify CertainTeed in writing of any defect promptly following its discovery, and shall submit with such notice proof of date of purchase and application in order to provide CertainTeed an opportunity to investigate the claim and examine the material alleged to be defective. Any claimed defect for which notice is not received by CertainTeed within the applicable warranty period is not covered by this warranty.

Notification shall be provided to CertainTeed Corporation, 1400 Union Meeting Rd., Blue Bell, Pa. 19422, Attention: Shelter Materials Group, Consumer Service Department. CertainTeed shall then promptly inspect the alleged defect and if such examination does disclose a defect covered by this warranty, shall, within a reasonable time after inspection, either repair or replace the defective shingles or make the appropriate contribution toward repair or replacement in accordance with the preceding paragraphs.

TRANSFERABILITY

This limited warranty may only be transferred to a subsequent owner of the building if either Hallmark Shingle®, Independence Shingle® or Horizon Shingle® was applied, and furthermore may only be transferred during the period of the SureStart Protection (five years) offered herein for the shingle applied as measured from the date of installation of the shingles. In the event that this warranty is effectively transferred, the warranty provisions shall not be altered and the subsequent owner shall be deemed the holder of this warranty and shall have the same rights and duties as the original homeowner/consumer.

This warranty is transferable to a new owner of the premises provided CertainTeed is notified in writing (at the address set forth in the preceding section entitled "Notification") by the new owner within 45 days of the real estate title transfer.

LIMITATIONS

1. CertainTeed shall have no liability under this warranty for:
 - a. Defects or failure caused by application of the shingles not in strict adherence with the written instructions of CertainTeed.
 - b. Any damage to the shingles caused by lightning, winds greater than 60 miles per hour (See Limited Wind Warranty which follows), hurricane, tornado, hailstorm,

earthquake, fire, explosion, flood, solid objects falling on the roof, or any causes, except for ordinary wear and tear by the elements, not in the control of CertainTeed.

c. Defects or damage caused by materials used as a roofing base over which the shingles are applied, damage to the roof caused by settlement, distortion, failure or cracking of the roof deck, walls or foundation of a building, or by traffic on the roof.

d. Damage caused by alteration after completion of the application of the shingles, whether such alteration be by structural additions, changes, or replacements, or by equipment installation (including, but not limited to, aerials, signs, water towers, fan housing, air conditioning equipment, and television antennas).

e. Damage to the roof due to any cause other than inherent manufacturing defects in the shingles.

f. Any variation in color or shading which may occur due to the positioning of the granules used as the surfacing material on the shingles.

g. If the applied shingle contains self-sealing asphalt strips, and if any of the strips fail to properly activate within the first year following the date of application of these shingles, CertainTeed shall have no liability under this warranty for such defects unless the aforesaid requirements pertaining to written notice to CertainTeed are met, and CertainTeed has been afforded the opportunity to hand seal, at its sole expense, any non-sealing shingles.

h. Fungus contamination, unless the applied shingle was sold as a fungus resistant shingle, in which event CertainTeed will repair or replace only such shingles which are proven to be contaminated with fungus or make the appropriate contribution toward repair or replacement of any such shingles in accordance with the preceding paragraphs.

2. CertainTeed reserves the right to discontinue or modify any of its products, including the color of said shingles, without notice to the original homeowner/consumer or a subsequent owner and shall not be liable to the original homeowner/consumer or a subsequent owner as a result of such discontinuance or modification, nor shall CertainTeed be liable in the event replacement material may vary in color in comparison to the original product as a result of normal weathering. If CertainTeed replaces any material under this warranty, it may substitute products designated by CertainTeed to be of comparable quality or price range in the event the product initially installed has been discontinued or modified.

OTHER CONDITIONS

1. This limited warranty gives you specific legal rights, and you may also have other rights which vary from state to state.
2. This limited warranty is not transferable except as provided in the preceding section entitled "Transferability".
3. This limited warranty, which is effective on shingles applied on or after January 1, 1992, supersedes that written warranty previously issued by CertainTeed coded No. 20-20-170.

4. THIS WARRANTY IS EXPRESSLY IN LIEU OF ALL OTHER ORAL OR WRITTEN WARRANTIES, LIABILITIES OR OBLIGATIONS OF CERTAINTEED. PERTINENT STATE LAW SHALL CONTROL FOR WHAT PERIOD OF TIME SUBSEQUENT TO SALE A CONSUMER/HOMEOWNER MAY SEEK A REMEDY PURSUANT TO THE IMPLIED WARRANTY OF MERCHANTABILITY OR OF FITNESS FOR A PARTICULAR PURPOSE. IN NO EVENT SHALL CERTAINTEED BE LIABLE FOR CONSEQUENTIAL OR INCIDENTAL DAMAGES OF ANY KIND, INCLUDING ANY DAMAGE TO THE BUILDING, ITS CONTENTS OR ANY PERSONS THEREIN, RESULTING FROM THE BREACH OF ANY WARRANTY SET FORTH HEREIN. NO REPRESENTATIVE OF CERTAINTEED OR ITS DISTRIBUTORS OR DEALERS IS AUTHORIZED TO MAKE ANY CHANGE OR MODIFICATIONS TO THIS WARRANTY. Some states do not allow limitations or the exclusion of incidental or consequential damages, so the above exclusions may not apply to you.

LIMITED WIND WARRANTY

CertainTeed manufactures all of its self-sealing asphalt fiber glass shingles to meet the requirements as stated in ASTM Standard Specification D3462, for both Tear Resistance (minimum 1700 grams, using ASTM Standard Test Method D1922) and Wind Resistance (using ASTM Standard Test Method D3161), and warrants that its fiber glass shingles will resist wind blow-off damage due to wind velocities, including "GUSTS", up to a maximum of 60 mph during the initial five (5) year period following application of the shingles. In addition, CertainTeed manufactures all of its asphalt organic shingles to meet the requirements of ASTM Standard Specification D225, to exceed 2000 grams tear resistance (using ASTM Standard Test Method D1922), and to meet the requirements for wind resistance as described in ASTM Standard Test Method D3161 (self-sealing and lock type shingles only), and CertainTeed warrants that its organic shingles will resist wind blow-off damage due to wind velocities, including "GUSTS", up to a maximum of 60 mph during the initial five (5) year period following application of the shingles.

If any such blow-off damage does occur during the first five (5) years of service from the completion date of application of the shingles, CertainTeed will furnish replacement shingles without charge for those shingles damaged (subject to the provisions of paragraph 2 under Limitations set forth above). This five (5) year Limited Wind Warranty does not cover the labor costs for removal or disposal of damaged shingles or application of the replacement shingles. In the event the shingles involved contain self-sealing asphalt strips, paragraph 1(g) under Limitations set forth above may apply during the first year after application. This Limited Wind Warranty is non-transferable unless the type of shingles applied were Hallmark Shingle®, Independence Shingle®, or Horizon Shingle®.

Any costs in excess of CertainTeed's contribution shall be the owners' responsibility through homeowner's insurance, etc.

WARRANTY LIMITED

1993



Asphalt Shingle Products

CertainTeed Corporation

P.O. Box 860 Valley Forge, PA 19482

This warranty covers asphalt shingle products sold only in the United States of America, its territories and Canada.

Type of Shingle (check one)	Warranty Period	Reduction Figure	Warranty Transferable to Subsequent Owner
<input type="checkbox"/> HALLMARK SHANGLE® Regular or Fungus Resistant	30 YRS. (360 MOS.)	1/360	YES*
<input type="checkbox"/> INDEPENDENCE SHANGLE® Regular or Fungus Resistant	30 YRS. (360 MOS.)	1/360	YES*
<input type="checkbox"/> HORIZON SHANGLE® Regular or Fungus Resistant	25 YRS. (300 MOS.)	1/300	YES*
<input type="checkbox"/> HEARTHSTEAD®	25 YRS. (300 MOS.)	1/300	YES*
<input type="checkbox"/> CUSTOM SEALDON®	25 YRS. (300 MOS.)	1/300	YES*
<input type="checkbox"/> MASTER SLAB®	25 YRS. (300 MOS.)	1/300	YES*
<input type="checkbox"/> XT™ 25	25 YRS. (300 MOS.)	1/300	YES*
<input type="checkbox"/> FUNGUSBUSTER® 25	25 YRS. (300 MOS.)	1/300	YES*
<input type="checkbox"/> CUSTOM LOK™ 25	25 YRS. (300 MOS.)	1/300	YES*
<input type="checkbox"/> CERTAINTEED 20	20 YRS. (240 MOS.)	1/240	YES*
<input type="checkbox"/> SEALDON® 20	20 YRS. (240 MOS.)	1/240	YES*
<input type="checkbox"/> SOLID SLAB™	20 YRS. (240 MOS.)	1/240	YES*

*See "Transferability" section on reverse side of this warranty for transferability limitations.

CertainTeed Corporation ("CertainTeed"), subject to the conditions and limitations set forth herein, warrants to the original homeowner/consumer that the asphalt shingles identified herein are free from manufacturing defects and will remain serviceable for the length of time specified for the shingle applied.

5-YEAR SURESTART™ PROTECTION

With respect to Hallmark, Independence, Horizon, Hearthstead, Custom Sealdon, Master Slab, XT25, FungusBuster 25 and Custom Lok 25 shingles only, CertainTeed, at its election, will repair or replace, free of charge, any shingles proven to be defective during the first five years after the completion of the application of said shingles up to a maximum liability which shall be equal to the

reasonable replacement cost of the defective shingles, including labor, exclusive of costs of roof tear-off and disposal and of flashing and metal work (and repairs required by defects therein). Should any shingles prove to be defective subsequent to the first five years following completion of shingle application, CertainTeed's maximum contribution toward the cost to the homeowner/consumer of repairing or replacing said defective shingles shall be calculated using the reasonable cost of replacement shingles, exclusive of labor, roof tear-off and disposal, and by then decreasing that amount by 1/360 (for Hallmark and Independence) and by 1/300 (for Horizon, Hearthstead, Custom Sealdon, Master Slab, XT25, FungusBuster 25 and Custom Lok 25) for each month of service measured from the date of installation of the shingles to the date when proven defective.

3-YEAR SURESTART™ PROTECTION

With respect to CertainTeed 20, Sealdon 20 and Solid Slab only, CertainTeed, at its election, will repair or replace, free of charge, any shingles proven to be defective during the first three years after the completion of the application of said shingles up to a maximum liability which shall be equal to the reasonable replacement cost of the defective shingles, including labor, exclusive of costs of roof tear-off and disposal and of flashing and metal work (and repairs required by defects therein). Should any shingles prove to be defective subsequent to the first three years following completion of shingle application, CertainTeed's maximum contribution toward the cost to the homeowner/consumer of repairing or replacing said



(Please Refer to Reverse Side for Remainder of Warranty, Including Limitations)

shingles shall be calculated using the reasonable cost of replacement shingles, exclusive of labor, roof tear-off and disposal, and by then decreasing that amount by 1/240 for each month of service measured from the date of installation of the shingles to the date when proven defective.

In the event of repair or replacement pursuant to the terms of this warranty, the warranty on the replacement shingles or on the repaired shingles will extend for the balance of the original warranty period in effect at the time the shingles prove defective.

NOTIFICATION

To obtain performance under the warranty, the original homeowner/consumer or subsequent owner, if applicable, shall notify CertainTeed in writing of any defect promptly following its discovery, and shall submit with such notice proof of date of purchase and application in order to provide CertainTeed an opportunity to investigate the claim and examine the material alleged to be defective. Any claimed defect for which notice is not received by CertainTeed within the applicable warranty period is not covered by this warranty.

Notification shall be provided to CertainTeed Corporation, 1400 Union Meeting Rd., Blue Bell, PA. 19422, Attention: Roofing Products Group, Consumer Service Department. CertainTeed shall then promptly inspect the alleged defect and if such examination does disclose a defect covered by this warranty, shall, within a reasonable time after inspection, either repair or replace the defective shingles or make the appropriate contribution toward repair or replacement in accordance with the preceding paragraphs.

TRANSFERABILITY

This limited warranty may be transferred by the original homeowner/consumer to a subsequent owner of the residence during the ten year period as measured from the date of installation of the shingles. In the event this warranty is effectively transferred, the remaining warranty duration will be limited, except for Shingle® products, to a period of two additional years as measured from the date of real estate title transfer. With respect to Shingle products, i.e., Hallmark, Independence and Horizon, if the warranty is effectively transferred during the 5-year SureStart period, then the warranty duration shall be that period cited in the chart above as measured from the date of installation, but if the warranty transfer occurs in years six through ten following shingle installation, then the remaining warranty duration will be limited to a period of two additional years as measured from the date of real estate title transfer. Otherwise, the warranty provisions shall not be altered and the subsequent owner shall be deemed the holder of this warranty and shall have the same rights and duties as the original homeowner/consumer. Accordingly, CertainTeed's maximum contribution toward the cost to the subsequent owner of repairing or replacing defective shingles shall, except in the case of Shingle products, be calculated using the reasonable cost of replacement shingles, exclusive of labor, roof tear-off and disposal, and by then decreasing that amount by the reduction figure (see chart above) for each month of service measured from the date of installation of the shingles to the date when proven defective, and in the case of Shingle products, shall be calculated in accordance with the terms of SureStart protection for said products (subject to the two year limitation on warranty duration should the warranty transfer occur subsequent to the SureStart period).

This warranty is transferable by the original purchaser to a new owner of the residence provided CertainTeed is notified in writing (at the address set forth in the preceding section enti-

led "Notification") by the new owner within 45 days of the real estate title transfer.

LIMITATIONS

1. CertainTeed shall have no liability under this warranty for:
 - a. Defects or failure caused by application of the shingles not in strict adherence with the written instructions of CertainTeed.
 - b. Any damage to the shingles caused by lightning, winds greater than 60 miles per hour (SEE Limited Wind Warranty which follows), hurricane, tornado, hailstorm, earthquake, fire, explosion, flood, solid objects falling on the roof, or any causes, except for ordinary wear and tear by the elements, not in the control of CertainTeed.
 - c. Defects or damage caused by materials used as a roofing base over which the shingles are applied, damage to the roof caused by settlement, distortion, failure or cracking of the roof deck, walls or foundation of a building, or by traffic on the roof.
 - d. Damage caused by alteration after completion of the application of the shingles, whether such alteration be by structural additions, changes, or replacements, or by equipment installation (including, but not limited to, aerials, signs, water towers, fan housing, air conditioning equipment, and television antennas).
 - e. Damage to the roof due to any cause other than inherent manufacturing defects in the shingles.
 - f. If the applied shingle contains self-sealing asphalt strips, and if any of the strips fail to properly activate within the first year following the date of application of these shingles, CertainTeed shall have no liability under this warranty for such defects unless the aforesaid requirements pertaining to written notice to CertainTeed are met, and CertainTeed has been afforded the opportunity to hand seal, at its sole expense, any non-sealing shingles.
 - g. Stains or contamination of any sort arising from outside sources (such as, but not limited to, algae, mildew, fungus, moss, lichens or other vegetation, or paint, chemicals or other similar materials), unless the applied asphalt shingle was sold as a "fungus resistant" shingle and unless the shingle has become contaminated with fungus or algae to an extent that is visually objectionable, in which event CertainTeed will repair or replace only such shingles which are proven to be contaminated with fungus or algae, or make the appropriate contribution toward repair or replacement of any such shingles in accordance with the preceding paragraphs.
2. CertainTeed reserves the right to discontinue or modify any of its products, including the color of said shingles, without notice to the original homeowner/consumer or the subsequent owner and shall not be liable to the original homeowner/consumer or the subsequent owner as a result of such discontinuance or modification, nor shall CertainTeed be liable in the event replacement material may vary in color in comparison to the original product as a result of normal weathering. If CertainTeed replaces any material under this warranty, it may substitute products designated by CertainTeed to be of comparable quality or price range in the event the product initially installed has been discontinued or modified.

OTHER CONDITIONS

1. This limited warranty gives you specific legal rights, and you may also have other rights which vary from state to state.
2. This limited warranty is not transferable except as provided in the preceding section entitled "Transferability".

3. This limited warranty, which is effective on shingles applied on or after January 1, 1993, supersedes that written warranty previously issued by CertainTeed coded No. 20-20-329.

4. THIS WARRANTY IS EXPRESSLY IN LIEU OF ALL OTHER ORAL OR WRITTEN WARRANTIES, LIABILITIES OR OBLIGATIONS OF CERTAINTEED. PERTINENT STATE LAW SHALL CONTROL FOR WHAT PERIOD OF TIME SUBSEQUENT TO SALE A CONSUMER/HOMEOWNER MAY SEEK A REMEDY PURSUANT TO THE IMPLIED WARRANTY OF MERCHANTABILITY OR OF FITNESS FOR A PARTICULAR PURPOSE. IN NO EVENT SHALL CERTAINTEED BE LIABLE FOR CONSEQUENTIAL OR INCIDENTAL DAMAGES OF ANY KIND, INCLUDING ANY DAMAGE TO THE BUILDING, ITS CONTENTS OR ANY PERSONS THEREIN, RESULTING FROM THE BREACH OF ANY WARRANTY SET FORTH HEREIN. NO REPRESENTATIVE OF CERTAINTEED OR ITS DISTRIBUTORS OR DEALERS IS AUTHORIZED TO MAKE ANY CHANGE OR MODIFICATION TO THIS WARRANTY.

Some states do not allow limitations on or the exclusion of incidental or consequential damages, so the above exclusions may not apply to you.

LIMITED WIND WARRANTY

CertainTeed manufactures all of its self-sealing asphalt fiber glass shingles to meet the requirements as stated in ASTM Standard Specification D3462, for both Tear Resistance (minimum 1700 grams, using ASTM Standard Test Method D1922) and Wind Resistance (using ASTM Standard Test Method D3161), and warrants that its fiber glass shingles will resist wind blow-off damage due to wind velocities, including "GUSTS," up to a maximum of 60 mph during the initial five (5) year period following application of the shingles. In addition, CertainTeed manufactures all of its asphalt organic shingles to meet the requirements of ASTM Standard Specification D225, to exceed 2000 grams tear resistance (using ASTM Standard Test Method D1922), and to meet the requirements for wind resistance as described in ASTM Standard Test Method D3161 (self-sealing and lock type shingles only), and CertainTeed warrants that its organic shingles will resist wind blow-off damage due to wind velocities, including "GUSTS," up to a maximum of 60 mph during the initial five (5) year period following application of the shingles.

If any such blow-off damage does occur during the first five (5) years of service from the completion date of application of the shingles, CertainTeed will furnish replacement shingles without charge for those shingles damaged (subject to the provisions of paragraph 2 under Limitations set forth above). This five (5) year Limited Wind Warranty does not cover the labor costs for removal or disposal of damaged shingles or application of the replacement shingles. In the event the shingles involved contain self-sealing asphalt strips, paragraph 1(f) under Limitations set forth above may apply during the first year after application. This Limited Wind Warranty is non-transferable unless the type of shingles applied were Hallmark Shingle®, Independence Shingle®, or Horizon Shingle®.

Any cost in excess of CertainTeed's contribution shall be the owner's responsibility through homeowner's insurance, etc.

W LIMITED WARRANTY



Asphalt Shingle Products

CertainTeed Corporation

P.O. Box 860, Valley Forge, PA 19482

*This warranty covers asphalt shingle products
sold only in the United States of America, its territories and Canada.*

PRODUCT	WARRANTY PERIOD	SURESTART™ PERIOD	REDUCTION FIGURE
HALLMARK SHANGLE®	30 YEARS	5 YEARS	1/360
INDEPENDENCE SHANGLE®	30 YEARS	5 YEARS	1/360
HORIZON SHANGLE®	25 YEARS	5 YEARS	1/300
CUSTOM SEALDON®	25 YEARS	5 YEARS	1/300
HEARTHSTEAD® SHINGLE	25 YEARS	5 YEARS	1/300
MASTER SLAB®	25 YEARS	5 YEARS	1/300
XT™ 25	25 YEARS	5 YEARS	1/300
FUNGUSBUSTER® 25	25 YEARS	5 YEARS	1/300
CUSTOM LOK™ 25	25 YEARS	5 YEARS	1/300
CERTAINTEED 20	20 YEARS	3 YEARS	1/240
SEALDON® 20	20 YEARS	3 YEARS	1/240
SOLID SLAB™	20 YEARS	3 YEARS	1/240

WHAT AND WHO IS COVERED AND FOR HOW LONG

PROVIDED SHINGLES HAVE BEEN INSTALLED IN STRICT ACCORDANCE WITH CERTAINTEED WRITTEN INSTALLATION INSTRUCTIONS, CERTAINTEED WARRANTIES TO THE ORIGINAL PROPERTY OWNER/CONSUMER THAT ITS ASPHALT ROOFING SHINGLES WILL BE FREE FROM MANUFACTURING DEFECTS FOR THE LENGTH OF TIME SPECIFIED IN THE CHART ABOVE, AND THAT CERTAINTEED WILL REPAIR OR REPLACE ANY SHINGLES PROVEN TO BE DEFECTIVE UNDER THE TERMS OF THIS WARRANTY.

SureStart™ Protection

All of CertainTeed's shingle products are covered by SureStart protection for the period specified in the chart above. Under this warranty feature, CertainTeed, at no charge, will repair or replace, at its option, any shingles proven to be defective during the applicable SureStart period (the SureStart period begins when shingle application has been completed). CertainTeed's maximum liability under SureStart will be equal to the reasonable cost to replace the defective shingles at current value, including labor, exclusive of costs of roof tear-off and disposal and of flashing and metal work (and repairs required by defects therein).

BEYOND SURESTART PROTECTION

Should any shingles prove to be defective subsequent to the SureStart period, CertainTeed's maximum contribution toward the cost of repairing or replacing the defective shingles will be calculated using the reasonable cost to replace the defective shingles at current value, exclusive of costs of labor, roof tear-off and disposal, and by then decreasing that amount by the reduction figure specified in the chart above for each month as measured from the date the shingles were installed to the date when proven defective.

In instances in which CertainTeed, per the terms of this warranty, has agreed to pay the cost of labor required to repair or replace defective shingles, CertainTeed will provide reimbursement only upon receipt of a copy of the contractor's invoice for the completion of such work or other written evidence of the completion of such work which CertainTeed in its sole discretion deems acceptable.

In the event of repair or replacement pursuant to the terms of this warranty, the warranty on the replacement or repaired shingles will extend for the balance of the warranty period in effect at the time the shingles prove defective.

TRANSFERABILITY

FOR ALL SHINGLE PRODUCTS

The warranty for all of CertainTeed's shingle products may be transferred by the original consumer to the subsequent property owner within the ten-year period following shingle installation. Should such a transfer occur, SureStart protection shall automatically terminate and the duration of the warranty, measured from the date of real estate title transfer, shall be two years unless the warranty transferred is for a Shangle product and the warranty transfer occurs during the SureStart period, in which event the following paragraph applies.

FOR SHANGLE PRODUCTS DURING THE SURESTART PERIOD

If the warranty for any of CertainTeed's Shangle products, (Hallmark, Independence and Horizon) is transferred by the original consumer to the subsequent property owner during the five-year SureStart period, the duration of the warranty, measured from the date of installation, will remain the same as for the original consumer, and the remaining period of SureStart protection will be available to the subsequent property owner.



CertainTeed

(PLEASE REFER TO NEXT PAGE FOR REMAINDER OF WARRANTY, INCLUDING OTHER CONDITIONS.)

In the event a Shingle product warranty is transferred by the original consumer subsequent to the five-year SureStart period but prior to ten years after installation, the warranty duration following the transfer will be only two years from the date of real estate title transfer.

LIMITATIONS

This warranty provides protection against any shingle defects that arise in the course of ordinary and everyday wear and tear to the roof caused by normal exposure to the elements. It does not provide protection against damage caused by situations and events beyond normal exposure conditions, such as but not limited to:

- winds greater than 60 miles per hour (See Limited Wind Warranty which follows), lightning, hurricane, tornado, hailstorm, earthquake, fire, explosion, flood, or falling objects.
- distortion, cracking or other failure of the base material over which the shingles are applied, or of the roof deck, or of the walls or foundation of the building itself.
- damage caused by structural changes, alterations, additions, or by the installation of equipment (such as aerials, signs or air conditioning equipment) to the structure, after the original shingles have been applied.
- stains or contamination to the shingle arising from such sources such as moss, paints, or chemicals, with the exception of fungus or algae if the shingle was sold as a "fungus-resistant shingle."

If the applied shingles contain self-sealing asphalt strips, and if any of these strips fail to activate within the first year following application, CertainTeed shall have no liability under this warranty for such a defect unless CertainTeed is afforded the opportunity to hand-seal, at its sole expense, any non-sealing shingles.

CertainTeed reserves the right to discontinue or modify any of its products, including the color of the shingles, and shall not be liable as a result of such discontinuance or modification, nor shall CertainTeed be liable in the event replacement material may vary in color in comparison to the original product as a result of normal weathering. If CertainTeed replaces any material under this warranty, it may substitute products designated by CertainTeed to be of comparable quality or price range in the event the product initially installed has been discontinued or modified.

LIMITED WIND WARRANTY

CertainTeed warrants both its fiber glass asphalt shingles and its organic base asphalt shingles to resist blow-off damage due to wind velocities, including gusts, up to 60 miles per hour during the initial five-year period following application of the shingles. If any such blow-off damage does occur during the first five years after application, CertainTeed will furnish replacement shingles without charge for those shingles (but will not be responsible for labor costs pertaining to removal or replacement of damaged shingles). However, in the event the shingles involved contain self-sealing asphalt strips, CertainTeed shall have no liability under this Limited Wind Warranty unless it is afforded the opportunity to hand-seal, at its sole expense, any non-sealing asphalt strips which fail to activate within the first year after application.

WHAT THE CUSTOMER MUST DO

The property owner must promptly notify CertainTeed in writing of any manufacturing defect and provide proof of the date of purchase and date of application of the shingles. CertainTeed will then investigate the claim, and if a defect covered by this warranty is confirmed, CertainTeed, within a reasonable amount of time after the inspection, will repair or replace the defective shingles or reimburse the property owner the appropriate amount for the repair or replacement of the shingles per the terms of the warranty.

Notification should be sent to:

CertainTeed Corporation
1400 Union Meeting Road
Blue Bell, PA 19422
Attn.: RPG Consumer Service Dept.

This warranty, which is effective on shingles applied on or after January 1, 1994, supersedes that written warranty previously issued by CertainTeed coded No. 20-20-444.

This warranty gives you specific legal rights, and you may also have other rights that vary from state to state.

THIS WARRANTY REPLACES ALL OTHER ORAL OR WRITTEN WARRANTIES, LIABILITIES OR OBLIGATIONS OF CERTAINTEED. PERTINENT STATE LAW SHALL CONTROL FOR WHAT PERIOD OF TIME SUBSEQUENT TO SALE A CONSUMER/HOMEOWNER MAY SEEK A REMEDY PURSUANT TO THE IMPLIED WARRANTY OF MERCHANTABILITY OR FITNESS FOR A PARTICULAR PURPOSE. IN NO EVENT SHALL CERTAINTEED BE LIABLE FOR CONSEQUENTIAL OR INCIDENTAL DAMAGES OF ANY KIND, INCLUDING ANY DAMAGE TO THE BUILDING, ITS CONTENTS OR ANY PERSONS THEREIN, RESULTING FROM THE BREACH OF ANY WARRANTY SET FORTH HEREIN. CERTAINTEED DOES NOT AUTHORIZE ITS REPRESENTATIVES, DISTRIBUTORS OR DEALERS TO MAKE ANY CHANGE OR MODIFICATION TO THIS WARRANTY. SOME STATES DO NOT ALLOW LIMITATIONS ON OR THE EXCLUSION OF INCIDENTAL OR CONSEQUENTIAL DAMAGES, SO THE ABOVE EXCLUSIONS MAY NOT APPLY TO YOU.

Some states do not allow limitations on or the exclusion of incidental or consequential damages, so the above exclusions may not apply to you.

CertainTeed Corporation
Roofing Products Group
P.O. Box 860
Valley Forge, PA 19482
800-345-1145

ASPHALT SHINGLES: FIBER GLASS AND ORGANIC

CertainTeed roofing products are sold by the Roofing Products Group of CertainTeed Corporation. They are manufactured in three

roofing plants and sold in three sales regions, as well as special product areas (SPA).

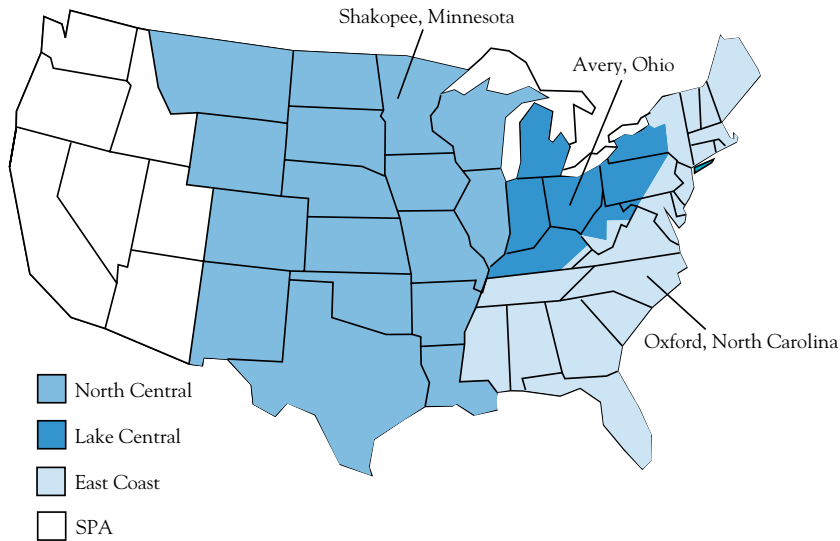

A HISTORY OF QUALITY

Since the early 1900's, CertainTeed has been an innovator in the building materials industry, today producing and selling vinyl windows, vinyl siding and accessories, asphalt roofing shingles, roof ventilation products, clay roof tiles, fiber glass insulation and

reinforcements, and PVC pipe at more than 100 facilities nationwide. Continuing the 90-year commitment of "quality made *certain*, satisfaction *guaranteed*," CertainTeed remains one of the most trusted names in the industry.

CertainTeed Corporation
Roofing Products Group
P.O. Box 860
Valley Forge, PA 19482
800-345-1145

ASPHALT SHINGLE PRODUCTS
CERTAINTEED CORPORATION

LIMITED

WARRANTY



CONGRATULATIONS!

... and thank you for your recent purchase of one of the fine products in the CertainTeed Roofing Collection™. Since 1904, CertainTeed has been producing quality roofing products that provide long-lasting beauty and protection for homes of every size, style and age. For the past ninety years, the basis for our name, “Quality made certain, satisfaction guaranteed,” has been our ongoing philosophy.

Your CertainTeed roofing warranty fully explains how CertainTeed supports its products with the strongest warranty protection available. In the following paragraphs we would like to highlight some of the more important warranty features, and provide some additional information that will help you understand why the quality of your CertainTeed roof is not just a claim, but a fact.

However, it is important that you read the warranty itself, which appears on pages 5, 6 and 7 of this brochure. The warranty lists the specific CertainTeed asphalt shingle products that are covered and the period of time for which they are covered. Take the time to understand how CertainTeed protects your purchase by standing behind our products.

SURESTART™ PROTECTION



Because CertainTeed roofing products are manufactured to the highest quality standards, we confidently include the additional assurance of SureStart™ protection to all CertainTeed shingles. SureStart provides the strongest protection you can get in the vital early years after your new roof has been installed.

Simply put, if a manufacturing defect is discovered, CertainTeed will provide reimbursement of **100% of the cost of the shingles and labor**

(exclusive of costs of tear-off and disposal and of flashing and metal work) required to repair or replace the defective product. And, SureStart protection is not prorated or otherwise reduced over time.

SureStart protection does not extend to any shingles applied to insulated roof deck systems that have not been ventilated between the insulation and the deck.

TRANSFERABILITY

The warranties for CertainTeed Shingle® products (Hallmark Shingle®, Independence Shingle® and Horizon Shingle®) are transferable by the original property owner to the subsequent owner during the five-year SureStart period. Upon transfer of the warranty, the remaining duration of the warranty for the new owner is the same as it would have been for the original owner. **And the, remaining period of SureStart protection will be available to the subsequent property owner.**

The warranties for **all** other CertainTeed shingle products are transferable during the first

ten years of service. Once effectively transferred according to the terms of the warranty, the remaining duration of the transferred warranty will be **two** years from the date of real estate title transfer. For non-Shingle products, any SureStart protection remaining to the original consumer prior to the transfer is automatically terminated.

Similarly, for Shingle products transferred after the five-year SureStart period has elapsed, but before completion of the tenth year of service, the remaining duration of the transferred warranty also will be **two** years.

WARRANTY PROTECTION AGAINST FUNGUS



In the East Coast sales region, several of CertainTeed's fiber glass shingles are available in a fungus-resistant version. Commonly called “fungus,” the black and green algae that creates unsightly streaking on shingles is a common occurrence in warm, humid climates.

CertainTeed provides exceptional warranty protection against fungus and algae contamination. Horizon Shingle, and FungusBuster® 25 carry a 25-year limited warranty against fungus growth.

ASPHALT SHINGLES: FIBER GLASS AND ORGANIC

As you may know, there are two basic types of asphalt shingles. Each consists of a core material that is coated with asphalt, and then covered with granules. This core, or base, material may be either fiber glass mat or organic felt. Shingles made of each type of base material possess specific characteristics and attributes that recommend them for particular situations.

FIBER GLASS SHINGLES

Fiber glass shingles carry a **Class A** fire resistance rating from Underwriters Laboratories (UL), **the highest fire rating available**. Thus, fiber glass shingles are the best protection against the spread of flame on a roof.

Fiber glass shingles are so called because they are built on a core, or mat, of **fiber glass reinforcement**. Asphalt coating is applied directly to this mat, and protective, colored granules are imbedded into the coating. Since the mat does not need to be saturated with asphalt, fiber glass shingles are **lighter in weight** than organic shingles and are more resistant to heat and humidity. Perhaps the most important factor that influences the quality of fiber glass

shingle performance is the **quality of the mat** used in the construction of the shingle. Throughout the roofing industry, the quality of fiber glass mats varies widely.

The American Society for Testing and Materials (**ASTM**) has established a standard of performance for fiber glass shingles, **ASTM D3462**, “Standard Specification for Fiber Glass Asphalt Shingles.” This test measures the force, in grams, required to tear a shingle in a specialized measuring device known as the “Elmendorf Tear Tester.” As measured this way, the **minimum tear strength required by ASTM is 1,700 grams**. In repeated tests conducted regularly by CertainTeed and by independent testing laboratories, **CertainTeed shingles have consistently demonstrated the best tear strength rating, and have never failed to comply with all of the requirements of ASTM D3462. This performance is certified by Underwriters Laboratories.**

No other fiber glass shingle manufacturer can make, and substantiate, all these claims.

ORGANIC SHINGLES

Organic shingles have a thick, **organic felt base reinforcement**. In the manufacturing process, the felt is saturated with a soft, flexible asphalt. It is then completely coated on both sides with tougher coating asphalt and then covered with granules. The result is a **tough, durable shingle with excellent durability in extreme cold weather and good performance characteristics in extreme heat**. Organic shingles carry a **Class “C”** fire resistance rating from Underwriters Laboratories.

Characteristics that equate to high or low quality in an organic base shingle include **tear strength, flexibility, and cold weather handling**.

ASTM does not provide a standard test for tear strength in organic shingles. Nevertheless, a good organic shingle with **tear strength well over 2,000 grams typically will demonstrate excellent cold weather, high wind performance**.

One measure of the flexibility of a shingle is an **“Uplift Flexibility”** test in which the shingle is bent in the same direction as it would be by the action of the wind. The load required to bend the shingle through a range of angles up to 90 degrees is recorded and used to calculate the flexibility index expressed as a percentage. **A good organic shingle will have a flexibility index of 50% or greater**. A high value is one indication of a shingle’s toughness, especially at low temperatures, its resistance to blow-off and damage in handling, and its ability to resist cracking as it ages in service on the roof.

All of CertainTeed’s organic base asphalt shingles demonstrate tear strength well over 2,000 grams, and uplift flexibility indexes greater than 50%.

WHAT IS A “SHANGLE®”?

The “Shangle®,” a term coined and an idea conceived by CertainTeed over thirty years ago, is the original “laminated shingle.” Only the Shangle features a full size, one-piece shingle as a base, the best protection against shingle separation. Individual shingle tabs or overlay pads are then applied to the base shingle, providing extra protection and aesthetic enhancement to the roof.

LIMITED WARRANTY

This warranty covers asphalt shingle products sold only in the United States of America, its territories and Canada.

WHAT AND WHO IS COVERED AND FOR HOW LONG

PROVIDED SHINGLES HAVE BEEN INSTALLED IN STRICT ACCORDANCE WITH CERTAINTTEED WRITTEN INSTALLATION INSTRUCTIONS, CERTAINTTEED WARRANTS TO THE ORIGINAL PROPERTY OWNER/CONSUMER THAT ITS ASPHALT ROOFING SHINGLES WILL BE FREE FROM MANUFACTURING DEFECTS FOR THE LENGTH OF TIME SPECIFIED IN THE CHART BELOW, AND THAT CERTAINTTEED WILL REPAIR OR REPLACE ANY SHINGLES PROVEN TO BE DEFECTIVE UNDER THE TERMS OF THIS WARRANTY.

IN ADDITION, CERTAINTTEED WARRANTS THAT HORIZON SHANGLE® AND FUNGUSBUSTER® 25 SHINGLES THAT WERE SOLD AS “FUNGUS RESISTANT SHINGLES” WILL REMAIN FREE FROM ALGAE AND FUNGUS GROWTH WHICH ADVERSELY AFFECT THE OVERALL APPEARANCE OF SAID SHINGLES FOR A PERIOD OF TWENTY-FIVE (25) YEARS. HOWEVER, CERTAINTTEED RESERVES THE RIGHT TO CLEAN THE FUNGUS OR ALGAE STAINS FROM THE SHINGLES RATHER THAN REPAIR OR REPLACE THE CONTAMINATED SHINGLES.

PRODUCT	WARRANTY PERIOD	SURESTART™ PERIOD	REDUCTION FIGURE
HALLMARK SHANGLE®	30 YEARS	5 YEARS	1/360
INDEPENDENCE SHANGLE®	30 YEARS	5 YEARS	1/360
HORIZON SHANGLE®	25 YEARS	5 YEARS	1/300
CUSTOM SEALDON® 30	30 YEARS	5 YEARS	1/360
HEARTHSTEAD® SHINGLE	25 YEARS	5 YEARS	1/300
MASTER SLAB®	25 YEARS	5 YEARS	1/300
XT™25	25 YEARS	5 YEARS	1/300
SEALDON®25	25 YEARS	5 YEARS	1/300
FUNGUSBUSTER®25	25 YEARS	5 YEARS	1/300
CUSTOM LOK™ 25	25 YEARS	5 YEARS	1/300
CERTAINTTEED 20	20 YEARS	3 YEARS	1/240
SOLID SLAB™	20 YEARS	3 YEARS	1/240
ANY SHINGLES APPLIED TO UNVENTILATED, INSULATED ROOF DECKS	10 YEARS	N/A	1/120

SURESTART™ PROTECTION

All of CertainTeed’s shingle products are covered by SureStart protection for the period specified in the chart above. Under this warranty feature, CertainTeed, at no charge, will repair or replace, at its option, any shingles proven to be defective during the applicable SureStart period (the SureStart period begins when shingle application has been completed). CertainTeed’s maximum liability under SureStart will be equal to the reasonable cost to replace the defective shingles at current value, including labor, exclusive of costs of roof tear-off and disposal and of flashing and metal work (and repairs required by defects therein).

SureStart protection does not extend to any shingles applied to insulated roof deck systems that are not ventilated between the insulation and the deck material upon which the shingles are attached. In the case of these shingles, CertainTeed’s maximum contribution toward the cost of repairing or replacing the defective shingles will be calculated using the reasonable cost to replace the defective shingles at current value, exclusive of costs of labor, roof tear-off and disposal, and by then decreasing that amount by the reduction figure specified in the chart above for each month as measured from the date the shingles were installed to the date when proven defective.

In instances in which CertainTeed, under the terms of this warranty, has agreed to pay the cost of labor required to repair, replace or clean defective or contaminated shingles, CertainTeed will provide reimbursement only upon receipt of a copy of the contractor’s invoice for the completion of such work or other written evidence of the completion of such work which CertainTeed, in its sole discretion, deems acceptable.

(PLEASE REFER TO NEXT TWO PAGES FOR REMAINDER OF WARRANTY, INCLUDING OTHER CONDITIONS.)

BEYOND SURESTART PROTECTION

Should any shingles prove to be defective subsequent to the SureStart period, CertainTeed's maximum contribution toward the cost of repairing or replacing the defective shingles will be calculated using the reasonable cost to replace the defective shingles at current value, exclusive of costs of labor, roof tear-off and disposal, and by then decreasing that amount by the reduction figure specified in the chart above for each month as measured from the date the shingles were installed to the date when proven defective or are found to be contaminated.

In the event of repair, replacement or cleaning pursuant to the terms of this warranty, the warranty on the replaced, repaired or cleaned shingles will extend for the balance of the warranty period in effect at the time the shingles prove defective or are found to be contaminated.

TRANSFERABILITY

FOR ALL SHINGLE PRODUCTS

The warranty for all of CertainTeed's shingle products may be transferred by the original consumer to the subsequent property owner within the ten-year period following shingle installation. Should such a transfer occur, SureStart protection shall automatically terminate and the duration of the warranty, measured from the date of real estate title transfer, shall be two years unless the warranty transferred is for a Shingle product and the warranty transfer occurs during the SureStart period, in which event the following paragraph applies.

FOR SHANGLE® PRODUCTS DURING THE SURESTART PERIOD

If the warranty for any of CertainTeed's Shangle products (Hallmark, Independence and Horizon) is transferred by the original consumer to the subsequent property owner during the five-year SureStart period, the duration of the warranty, measured from the date of installation, will remain the same as for the original consumer, and the remaining period of SureStart protection will be available to the subsequent property owner.

In the event a Shangle product warranty is transferred by the original consumer subsequent to the five-year SureStart period but prior to ten years after installation, the warranty duration following the transfer will be only two years from the date of real estate title transfer.

LIMITATIONS

This warranty provides protection against any shingle defects that arise in the course of ordinary and everyday wear and tear to the roof caused by normal exposure to the elements. It does not provide protection against damage caused by situations and events beyond normal exposure conditions, such as but not limited to:

- winds greater than 60 miles per hour (See Limited Wind Warranty which follows), lightning, hurricane, tornado, hailstorm, earthquake, fire, explosion, flood, or falling objects.
- distortion, cracking or other failure of the base material over which the shingles are applied, or of the roof deck, or of the walls or foundation of the building itself.
- damage caused by structural changes, alterations or additions, or by the installation of equipment (such as aerials, signs or air conditioning equipment) to the structure, after the original shingles have been applied.
- stains or contamination to the shingle arising from sources such as, but not limited to, moss, lichens or other vegetation, or paints, chemicals or other similar materials, unless the applied asphalt shingle was sold as a "fungus-resistant shingle," in which case CertainTeed will clean, repair or replace (including costs of labor, roof tear-off and disposal), at its option, only such shingles which are proven to be contaminated with fungus or algae during the term of the warranty against fungus and algae growth.

If the applied shingles contain self-sealing asphalt strips, and if any of these strips fail to activate within the first year following application, CertainTeed shall have no liability under this warranty for such a defect unless CertainTeed is afforded the opportunity to hand-seal, at its sole expense, any non-sealing shingles.

CertainTeed limits its warranty protection to a ten (10) year duration (from date of completion of shingle application) for shingles applied to insulated roof deck systems that have not been ventilated between the deck material and the insulation.

CertainTeed reserves the right to discontinue or modify any of its products, including the color of the shingles, and shall not be liable as a result of such discontinuance or modification, nor shall CertainTeed be liable in the

event replacement material may vary in color in comparison to the original product as a result of normal weathering. If CertainTeed replaces any material under this warranty, it may substitute products designated by CertainTeed to be of comparable quality or price range in the event the product initially installed has been discontinued or modified.

LIMITED WIND WARRANTY

CertainTeed warrants both its fiber glass asphalt shingles and its organic base asphalt shingles to resist blow-off damage due to wind velocities, including gusts, up to 60 miles per hour during the initial five year period following application of the shingles. If any such blow-off damage does occur during the first five-years after application, CertainTeed will furnish replacement shingles without charge for those shingles damaged (but will not be responsible for labor costs pertaining to removal or replacement of damaged shingles). However, in the event the shingles involved contain self-sealing asphalt strips, CertainTeed shall have no liability under this Limited Wind Warranty unless it is afforded the opportunity to hand-seal, at its sole expense, any non-sealing asphalt strips which fail to activate within the first year after application. Any costs in excess of CertainTeed's contribution shall be the owner's responsibility through homeowners' insurance, etc.

WHAT THE CUSTOMER MUST DO

The property owner must promptly notify CertainTeed in writing of any manufacturing defect or fungus or algae contamination and provide proof of the date of purchase and date of application of the shingles. CertainTeed will then investigate the claim, and if a defect or contamination covered by this warranty is confirmed, CertainTeed, within a reasonable amount of time after the inspection, will repair, replace or clean the defective or contaminated shingles or reimburse the property owner the appropriate amount for the repair, replacement or cleaning of the shingles under the terms of the warranty.

Notification should be sent to:

CertainTeed Corporation
1400 Union Meeting Road
Blue Bell, PA 19422
Attn.: RPG Consumer Service Dept.

This warranty, which is effective on shingles applied on or after August 1, 1995, supersedes that written warranty previously issued by CertainTeed coded No. 20-20-804.

THIS WARRANTY REPLACES ALL OTHER ORAL OR WRITTEN WARRANTIES, LIABILITIES OR OBLIGATIONS OF CERTAINTEED. PERTINENT STATE LAW SHALL CONTROL FOR WHAT PERIOD OF TIME SUBSEQUENT TO SALE A CONSUMER/HOMEOWNER MAY SEEK A REMEDY PURSUANT TO THE IMPLIED WARRANTY OF MERCHANTABILITY OR FITNESS FOR A PARTICULAR PURPOSE. IN NO EVENT SHALL CERTAINTEED BE LIABLE FOR CONSEQUENTIAL OR INCIDENTAL DAMAGES OF ANY KIND, INCLUDING ANY DAMAGE TO THE BUILDING, ITS CONTENTS OR ANY PERSONS THEREIN, RESULTING FROM THE BREACH OF ANY WARRANTY SET FORTH HEREIN. CERTAINTEED DOES NOT AUTHORIZE ITS REPRESENTATIVES, DISTRIBUTORS OR DEALERS TO MAKE ANY CHANGE OR MODIFICATION TO THIS WARRANTY. SOME STATES DO NOT ALLOW LIMITATIONS ON OR THE EXCLUSION OF INCIDENTAL OR CONSEQUENTIAL DAMAGES, SO THE ABOVE EXCLUSIONS MAY NOT APPLY TO YOU.

This warranty gives you specific legal rights, and you may also have other rights that vary from state to state.

Return of the warranty registration card is not required as a condition of warranty coverage.



ASPHALT SHINGLE PRODUCTS
CERTAINTEED CORPORATION



LIMITED

WARRANTY



CONGRATULATIONS! ... and thank you for your recent purchase of one of the fine products in the CertainTeed Roofing Collection™. Since 1904, CertainTeed has been producing quality roofing products that provide long-lasting beauty and protection for homes of every size, style and age. For the past 90 years, the basis for our name, “Quality made *certain*, satisfaction guaranteed,” has been our ongoing philosophy.

Your CertainTeed roofing warranty fully explains how CertainTeed supports its products with the strongest warranty protection available. In the following paragraphs we would like to highlight some of the more important warranty features, and provide some additional information that will help you understand why the quality of your CertainTeed roof is not just a claim, but a fact.

However, it is important that you read the warranty section of this brochure. The warranty lists the specific CertainTeed asphalt shingle products that are covered and the period of time for which they are covered. Take the time to understand how CertainTeed protects your purchase by standing behind our products.

SURESTART™ PROTECTION

Because CertainTeed roofing products are manufactured to the highest quality standards, we confidently include the additional assurance of SureStart™ protection with all CertainTeed shingles. SureStart provides the strongest protection you can get in the vital early years after your new roof has been installed.

Simply put, if a manufacturing defect is discovered during the SureStart period, CertainTeed

will provide reimbursement of 100% of the cost of the shingles and labor (exclusive of costs of tear-off and flashings) required to repair or replace the defective product. And, SureStart protection is not prorated or otherwise reduced over time.

SureStart protection does not extend to any shingles applied to insulated roof deck systems that have not been ventilated between the insulation and the deck.

TRANSFERABILITY

The warranties for CertainTeed multi-layer products (Hallmark Shingle®, Independence Shingle®, Horizon Shingle®, Landmark™ and Landmark™ XL) are transferable by the original property owner to the subsequent owner during the first 10 years of service. Upon transfer of the warranty during the five-year SureStart period, the remaining duration of the warranty for the new owner is the same as it would have been for the original owner.

And, the remaining period of SureStart protection will be available to the subsequent property owner.

For multi-layer product warranties transferred after the SureStart period has elapsed, but before completion of the tenth year of service, the remaining duration of the transferred warranty will be **two** years.

The warranties for CertainTeed single-layer shingle products (Custom Sealdon® 30, Hearthstead®, XT™ 25, Sealdon® 25, FungusBuster® 25, Custom Lok™, Solid Slab™ and CertainTeed 20) are also transferable by the original property owner during the first **10** years of service. Once effectively transferred according to the terms of the warranty,

the remaining duration of the transferred warranty will be **two** years from the date of real estate title transfer. For these products,

any SureStart protection remaining to the original consumer prior to the transfer is automatically terminated.

WARRANTY PROTECTION AGAINST FUNGUS

*I*n the East Coast sales region, several of CertainTeed's fiber glass shingles are available in a fungus-resistant version. Commonly called "fungus", the black and green algae that creates unsightly streaking on shingles is a common occurrence in warm, humid climates.



CertainTeed provides the strongest warranty protection against fungus and algae contamination. Horizon Shingle®, and FungusBuster® 25 carry a 15-year Limited warranty against fungus growth.

ASPHALT SHINGLES FIBER GLASS AND ORGANIC

*A*s you may know, there are two basic types of asphalt shingles. Each consists of a core material that is coated with asphalt, and then covered with granules. This core, or base, material may

be either fiber glass mat or organic felt. Shingles made of each type of base material possess specific characteristics and attributes that recommend them for particular situations.

Fiber Glass Shingles

Fiber glass shingles carry a **Class A** fire resistance rating from Underwriters Laboratories (UL), **the highest fire rating available**. Thus, fiber glass shingles are the best protection against the spread of flame on a roof.

Fiber glass shingles are so called because they are built on a core, or mat, of **fiber glass reinforcement**. Asphalt coating is applied directly to this mat, and protective, colored granules are embedded into the coating. Since the mat does not need to be saturated with asphalt, fiber glass shingles are **lighter in weight** than organic shingles and are more resistant to heat and humidity. Perhaps the most important factor that influences the quality of fiber glass shingle performance is the **quality of the mat** used in the construction of the shingle. Throughout the roofing industry, the quality of fiber glass mats varies widely.

The American Society for Testing and Materials (ASTM) has established a standard of performance for fiber glass shingles, **ASTM D3462**, "Standard Specification for Fiber Glass Asphalt Shingles." This test measures the force, in grams, required to tear a shingle in a specialized measuring device known as the "Elmendorf Tear Tester." As measured this way, the **minimum tear strength required by ASTM is 1700 grams**. In repeated tests conducted regularly by CertainTeed and by independent testing laboratories, **CertainTeed shingles have consistently demonstrated the best tear strength rating, and have never failed to comply with all of the requirements of ASTM D3462. This performance is certified by Underwriters Laboratories.**

No other fiber glass shingle manufacturer can make, and substantiate, all these claims.

Organic Shingles

Organic shingles have a thick, **organic felt base reinforcement**. In the manufacturing process, the felt is saturated with a soft, flexible asphalt. It is then completely coated on both sides with tougher coating asphalt and then covered with granules. The result is a **tough, durable shingle with excellent durability in extreme cold weather and good performance characteristics in extreme heat.**

Organic shingles carry a **Class C** fire resistance rating from Underwriters Laboratories.

Characteristics that equate to high or low **quality** in an organic base shingle include **tear strength, flexibility and cold weather handling.**

ASTM does not provide a standard test for tear strength in organic shingles. Nevertheless, a good organic shingle with tear strength well

over 2,000 grams typically will demonstrate excellent cold weather, high wind performance.

One measure of the flexibility of a shingle is an **“Uplift Flexibility”** test in which the shingle is bent in the same direction as it would be by the action of the wind. The load required to bend the shingle through a range of angles up to 90 degrees is recorded and used to calculate the flexibility index expressed as a percentage. **A good organic shingle will have a flexibility index of 50% or greater.** A high value is one indication of a shingle’s toughness (especially at low temperature), its resistance to blow-off and damage in handling, and its ability to resist cracking as it ages in service on the roof.

All of CertainTeed’s organic-base asphalt shingles demonstrate tear strength well over 2,000 grams, and uplift flexibility indexes greater than 50%.

WHAT IS A “SHANGLE®”?

The “Shangle®,” an idea conceived by CertainTeed over 30 years ago, is the original “laminated shingle.” The Shangle features a full-size, one-piece shingle as a base, to which individual shingle tabs or overlay pads are applied, providing extra protection and aesthetic enhancement to the roof.

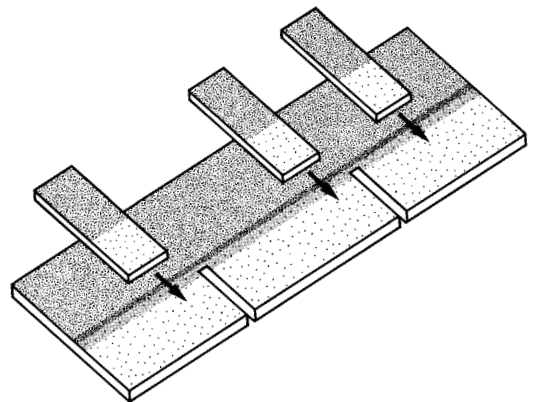

WHAT IS A TWO-PIECE LAMINATE?

Whereas Shangle consists of a full-size, one-piece base shingle onto which tabs or pads are applied, a two-piece laminate uses a full-size shingle with tab-size teeth cut out of it. Adhered to the back of this top shingle is a half shingle that runs behind the cut-outs. The result is a multi-layered shingle that provides a rugged, textured look on the roof.

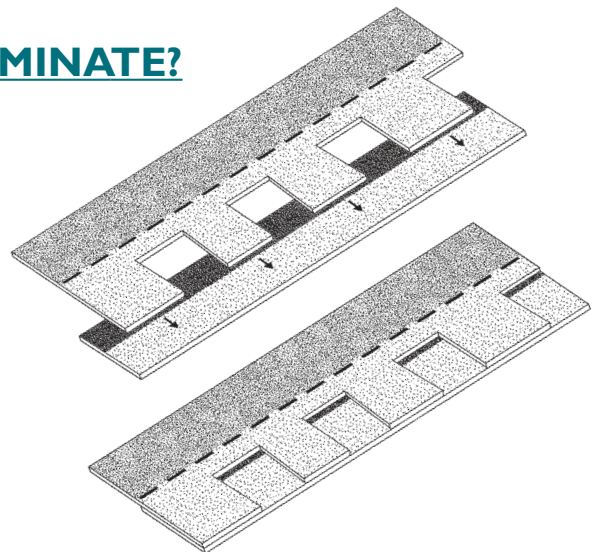

LIMITED WARRANTY

This warranty covers asphalt shingle products sold only in the United States of America, its territories and Canada.

What and Who is Covered and For How Long

Provided shingles have been installed in strict accordance with CertainTeed written installation instructions, CertainTeed warrants to the original property owner/consumer that its asphalt roofing shingles will be free from manufacturing defects for the length of time specified in the chart below, and that CertainTeed will repair or replace any shingles proven to be defective under the terms of this warranty.

In addition, CertainTeed warrants that Horizon Shingle® and Fungusbuster® 25 Shingles that were sold as “fungus-resistant shingles” will remain free from algae and fungus growth which adversely affect the overall appearance of said shingles for a period of fifteen (15) years. However, CertainTeed reserves the right to clean the fungus or algae stains from the shingles rather than repair or replace the contaminated shingles.

PRODUCT	WARRANTY PERIOD	SURESTART™ PERIOD	REDUCTION FIGURE
HALLMARK SHANGLE®	30 YEARS	5 YEARS	1/360
INDEPENDENCE SHANGLE®	30 YEARS	5 YEARS	1/360
LANDMARK™ XL	40 YEARS	5 YEARS	1/480
LANDMARK™	30 YEARS	5 YEARS	1/360
HORIZON SHANGLE®	25 YEARS	5 YEARS	1/300
CUSTOM SEALDON® 30	30 YEARS	5 YEARS	1/360
HEARTHSTEAD®	25 YEARS	5 YEARS	1/300
XT™ 25	25 YEARS	5 YEARS	1/300
SEALDON® 25	25 YEARS	5 YEARS	1/300
FUNGUSBUSTER® 25	25 YEARS	5 YEARS	1/300
CUSTOM LOK™ 25	25 YEARS	5 YEARS	1/300
SOLID SLAB™	25 YEARS	5 YEARS	1/300
CERTAINTEED 20	20 YEARS	3 YEARS	1/240
ANY SHINGLES APPLIED TO UNVENTILATED, INSULATED ROOF DECKS	10 YEARS	N/A	1/120

SureStart™ Protection

All of CertainTeed’s shingle products are covered by SureStart protection for the period specified in the chart above. Under this warranty feature, CertainTeed, at no charge, will repair or replace, at its option, any shingles proven to be defective during the applicable SureStart period (the SureStart period begins when shingle application has been completed). CertainTeed’s maximum liability under SureStart will be equal to the reasonable cost to replace the defective shingles at current value, including labor, exclusive of costs of roof tear-off and disposal and of flashing and metal work (and repairs required by defects therein).

SureStart protection does not extend to any shingles applied to insulated roof deck systems that are not ventilated between the insulation and the deck material upon which the shingles are attached. In the case of these shingles, CertainTeed’s maximum contribution toward the cost of repairing or replacing the defective shingles will be calculated using the reasonable cost to replace the defective shingles at current value, exclusive of costs of labor, roof tear-off and disposal, and by then decreasing that amount by the reduction figure specified in the chart above for each month as measured from the date the shingles were installed to the date when proven defective.

In instances in which CertainTeed, under the terms of this warranty, has agreed to pay the cost of labor required to repair, replace or clean defective or contaminated shingles, CertainTeed will provide reimbursement only upon receipt of a copy of the contractor’s invoice or other written evidence of the completion of such work for the completion of such work which CertainTeed, in its sole discretion, deems acceptable.

(PLEASE REFER TO NEXT TWO PAGES FOR REMAINDER OF WARRANTY INCLUDING OTHER CONDITIONS.)

Beyond Surestart Protection

Should any shingles prove to be defective subsequent to the SureStart period, CertainTeed's maximum contribution toward the cost of repairing or replacing the defective shingles will be calculated using the reasonable cost to replace the defective shingles at current value, exclusive of costs of labor, roof tear-off and disposal, and by then decreasing that amount by the reduction figure specified in the chart on the preceding page for each month as measured from the date the shingles were installed to the date when proven defective or are found to be contaminated.

In the event of repair, replacement or cleaning pursuant to the terms of this warranty, the warranty on the replaced, repaired or cleaned shingles will extend for the balance of the warranty period in effect at the time the shingles prove defective or are found to be contaminated.

Transferability

FOR ALL SHINGLE PRODUCTS

The warranty for all of CertainTeed's shingle products may be transferred by the original consumer to the subsequent property owner within the 10-year period following shingle installation. Should such a transfer occur, SureStart protection shall automatically terminate and the duration of the warranty, measured from the date of real estate title transfer, shall be two years unless the warranty transferred is for a multi-layered shingle product and the warranty transfer occurs during the SureStart period, in which event the following paragraph applies.

FOR MULTI-LAYER SHINGLE PRODUCTS DURING THE SURESTART PERIOD

If the warranty for any of CertainTeed's multi-layer shingle products (Hallmark Shingle, Independence Shingle, Horizon Shingle, Landmark and Landmark XL) is transferred by the original consumer to the subsequent property owner during the five-year SureStart period, the duration of the warranty, measured from the date of installation, will remain the same as for the original consumer, and the remaining period of SureStart protection will be available to the subsequent property owner.

In the event the warranty for a multi-layer shingle product is transferred by the original consumer subsequent to the five-year SureStart period but prior to ten years after installation, the warranty duration following the transfer will be only two years from the date of real estate title transfer.

Limitations

This warranty provides protection against any shingle defects that arise in the course of ordinary and everyday wear and tear to the roof caused by normal exposure to the elements. It does not provide protection against damage caused by situations and events beyond normal exposure conditions, such as but not limited to:

- winds greater than 60 miles per hour (See Limited Wind Warranty which follows), lightning, hurricane, tornado, hailstorm, earthquake, fire, explosion, flood or falling objects.
- distortion, cracking or other failure of the base material over which the shingles are applied, or of the roof deck, or of the walls or foundation of the building itself.
- damage caused by structural changes, alterations or additions, or by the installation of equipment (such as aerials, signs or air-conditioning equipment) to the structure after the original shingles have been applied.
- stains or contamination to the shingle arising from sources such as, but not limited to, moss, lichens or other vegetation, or paints, chemicals or other similar materials, unless the applied asphalt shingle was sold as a "fungus-resistant shingle", in which case CertainTeed will clean, repair or replace, at its option, per the terms of the warranty, only such shingles which are proven to be contaminated with fungus or algae during the term of the warranty against fungus and algae growth.

If the applied shingles contain self-sealing asphalt strips, and if any of these strips fail to activate within the first year following application, CertainTeed shall have no liability under this warranty for such a defect unless CertainTeed is afforded the opportunity to hand-seal, at its sole expense, any non-sealing shingles.

CertainTeed limits its warranty protection to a ten (10) year duration (from date of completion of shingle application) for shingles applied to insulated roof deck systems that have not been ventilated between the deck material and the insulation.

CertainTeed reserves the right to discontinue or modify any of its products, including the color of the shingles, and shall not be liable as a result of such discontinuance or modification, nor shall CertainTeed be liable in the event replacement material may vary in color in comparison to the original product as a result of normal weathering. If CertainTeed replaces any material under this warranty, it may substitute products designated by CertainTeed to be of comparable quality or price range in the event the product initially installed has been discontinued or modified.

Limited Wind Warranty

CertainTeed warrants both its fiber glass asphalt shingles and its organic-base asphalt shingles to resist blow-off damage due to wind velocities, including gusts, up to 60 miles per hour during the initial five-year period following application of the shingles. If any such blow-off damage does occur during the first five years after application, CertainTeed will furnish replacement shingles without charge for those shingles damaged (but will not be responsible for labor costs pertaining to removal or replacement of damaged shingles). However, in the event the shingles involved contain self-sealing asphalt strips, CertainTeed shall have no liability under this Limited Wind Warranty unless it is afforded the opportunity to hand-seal, at its sole expense, any non-sealing asphalt strips which fail to activate within the first year after application.

Any costs in excess of CertainTeed's contribution shall be the owner's responsibility through homeowner's insurance, etc.

What the Customer Must Do

The property owner must promptly notify CertainTeed in writing of any manufacturing defect or fungus or algae contamination and provide proof of the date of purchase and date of application of the shingles. CertainTeed will then investigate the claim, and if a defect or contamination covered by this warranty is confirmed, CertainTeed, within a reasonable amount of time after the inspection, will repair, replace or clean the defective or contaminated shingles or reimburse the property owner the appropriate amount for the repair, replacement or cleaning of the shingles under the terms of the warranty.

Notification should be sent to:

CertainTeed Corporation
1400 Union Meeting Road
Blue Bell, PA 19422
Attn.: RPG Consumer Service Dept.

This warranty, which is effective on shingles applied on or after January 1, 1996, supersedes that written warranty previously issued by CertainTeed coded No. 20-20-991.

THIS WARRANTY REPLACES ALL OTHER ORAL OR WRITTEN WARRANTIES, LIABILITIES OR OBLIGATIONS OF CERTAINTEED. PERTINENT STATE LAW SHALL CONTROL FOR WHAT PERIOD OF TIME SUBSEQUENT TO SALE A CONSUMER/HOMEOWNER MAY SEEK A REMEDY PURSUANT TO THE IMPLIED WARRANTY OF MERCHANTABILITY OR FITNESS FOR A PARTICULAR PURPOSE. IN NO EVENT SHALL CERTAINTEED BE LIABLE FOR CONSEQUENTIAL OR INCIDENTAL DAMAGES OF ANY KIND, INCLUDING ANY DAMAGE TO THE BUILDING, ITS CONTENTS OR ANY PERSONS THEREIN, RESULTING FROM THE BREACH OF ANY WARRANTY SET FORTH HEREIN. CERTAINTEED DOES NOT AUTHORIZE ITS REPRESENTATIVES, DISTRIBUTORS OR DEALERS TO MAKE ANY CHANGE OR MODIFICATION TO THIS WARRANTY. SOME STATES DO NOT ALLOW LIMITATIONS ON OR THE EXCLUSION OF INCIDENTAL OR CONSEQUENTIAL DAMAGES, SO THE ABOVE EXCLUSIONS MAY NOT APPLY TO YOU.

This warranty gives you specific legal rights, and you may also have other rights that vary from state to state.

Return of the warranty registration card is not required as a condition of warranty coverage.

ROOFING PLANTS AND REGIONAL SALES OFFICES

CertainTeed roofing products are sold by the Roofing Products Group of CertainTeed Corporation. They are manufactured in three roofing plants and sold in three sales regions, as well as special product areas (SPA).

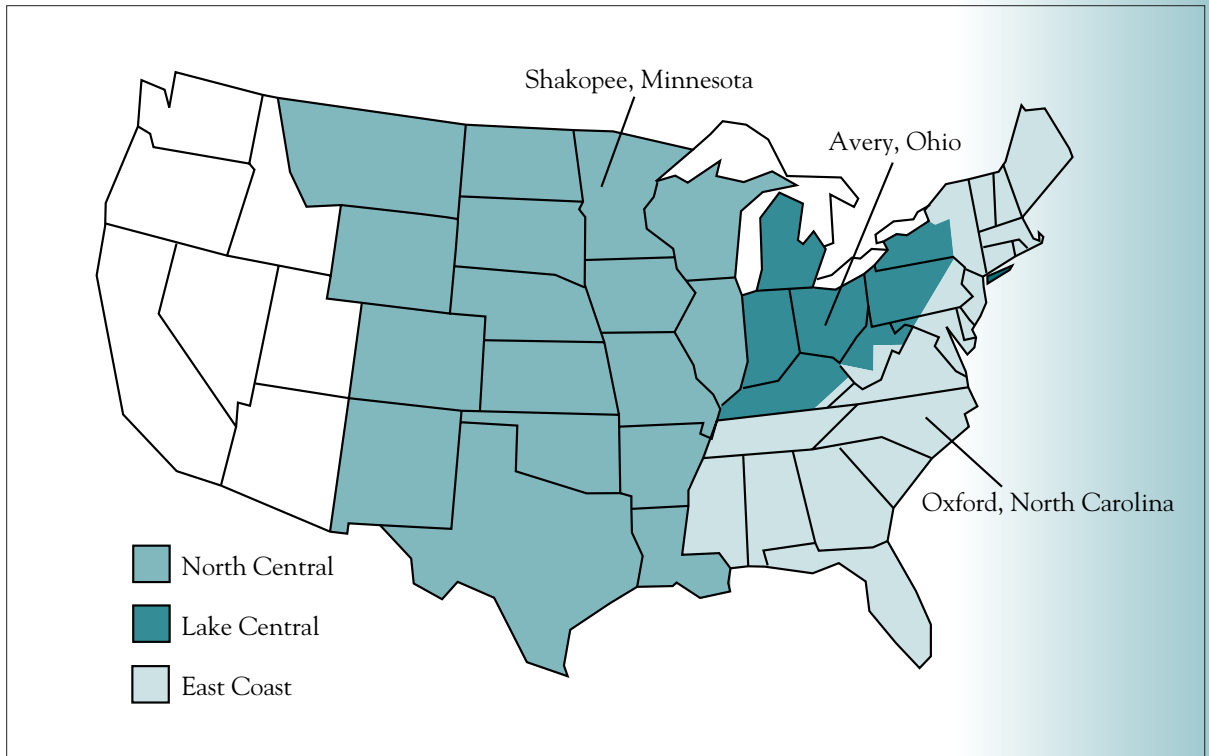

Since the early 1900s, CertainTeed has been an innovator in the building materials industry, today producing and selling vinyl windows, vinyl siding and accessories, asphalt roofing shingles, roof ventilation products, clay roof tiles, fiber glass insulation and reinforcements, and PVC pipe at more than 100 facilities nationwide. Continuing the 90-year commitment of “quality made *certain*, satisfaction guaranteed,” CertainTeed remains one of the most trusted names in the industry.

CertainTeed Corporation
Roofing Products Group
P.O. Box 860
Valley Forge, PA 19482
800-345-1145



ASPHALT SHINGLE PRODUCTS
CERTAINTEED CORPORATION



CertainTeed 

LIMITED

WARRANTY

CONGRATULATIONS!

... and thank you for your recent purchase of one of the fine products in the CertainTeed Roofing Collection™. Since 1904, CertainTeed has been producing quality roofing products that provide long-lasting beauty and protection for homes of every size, style and age. For the past 90 years, the basis for our name, “Quality made *certain*, satisfaction guaranteed,” has been our ongoing philosophy.

Your CertainTeed roofing warranty fully explains how CertainTeed supports its products with the strongest warranty protection available. In the following paragraphs we would like to highlight some of the more important warranty features, and provide some additional information that will help you understand why the quality of your CertainTeed roof is not just a claim, but a fact.

However, it is important that you read the warranty section of this brochure. The warranty lists the specific CertainTeed asphalt shingle products that are covered and the period of time for which they are covered. Take the time to understand how CertainTeed protects your purchase by standing behind our products.

SURESTART™ PROTECTION

Because CertainTeed roofing products are manufactured to the highest quality standards, we confidently include the additional assurance of SureStart™ protection with all CertainTeed shingles. SureStart provides the strongest protection you can get in the vital early years after your new roof has been installed.

Simply put, if a manufacturing defect is discovered during the SureStart period, CertainTeed will provide reimbursement of 100% of the cost of the shingles and labor to repair the defective shingles or apply new shingles to



replace the defective shingles (exclusive of costs of tear-off and flashings). SureStart protection is not prorated or otherwise reduced over time.

SureStart protection does not extend to any shingles applied to insulated roof deck systems that have not been ventilated between the insulation and the deck.

TRANSFERABILITY

The warranties for CertainTeed shingles are transferable by the original property owner to the subsequent owner. Upon transfer of the warranty during the product's SureStart period, the remaining duration of the warranty for the new owner is the same as it would have been for the original owner.

And, the remaining period of SureStart protection will be available to the subsequent property owner.

For product warranties transferred after the SureStart period has elapsed, the remaining duration of the transferred warranty will be **two** years from the date of real estate title transfer.

CertainTeed limits its warranty protection to a ten (10) year duration (from date of completion of shingle application to the end of the tenth year of service) for shingles applied to insulated roof deck systems that have not been ventilated between the deck material and the insulation. This warranty obligation is subject to the maximum material liability shown on the chart on page 5 and is reduced by the reduction figure shown on that chart.

CertainTeed reserves the right to discontinue or modify any of its products, including the color of the shingles, and shall not be liable as a result of such discontinuance or modification, nor shall CertainTeed be liable in the event replacement material may vary in color in comparison to the original product as a result of normal weathering. If CertainTeed replaces any material under this warranty, it may substitute products designated by CertainTeed to be of comparable quality or price range in the event the product initially installed has been discontinued or modified.

Limited Wind Warranty

CertainTeed warrants both its fiber glass asphalt shingles and its organic-base asphalt shingles to resist blow-off damage due to wind velocities, including gusts, up to 60 miles per hour during the initial five-year period following application of the shingles. If any such blow-off damage does occur during the first five years after application, CertainTeed will furnish replacement shingles without charge for those shingles damaged (but will not be responsible for labor costs pertaining to removal or replacement of damaged shingles). However, in the event the shingles involved contain self-sealing asphalt strips, CertainTeed shall have no liability under this Limited Wind Warranty unless it is first afforded the opportunity to hand-seal, at its sole expense, any non-sealing asphalt strips which fail to activate within the first year after application.

Any costs in excess of CertainTeed's contribution shall be the owner's responsibility through homeowner's insurance, etc.

What the Customer Must Do

The property owner must promptly notify CertainTeed in writing of any manufacturing defect or fungus or algae contamination and provide proof of the date of purchase and date of application of the shingles. CertainTeed will then investigate the claim, and if a defect covered by this warranty is confirmed, CertainTeed, within a reasonable amount of time after the inspection, will repair, replace or clean the defective shingles or reimburse the property owner the appropriate amount for the repair, replacement or cleaning of the shingles under the terms of the warranty.

Notification should be sent to:

CertainTeed Corporation
1400 Union Meeting Road
Blue Bell, PA 19422
Attn: RPG Consumer Service Dept.

This warranty, which is effective on shingles applied on or after January 1, 1997, supersedes that written warranty previously issued by CertainTeed coded No. 20-20-1013.

THIS WARRANTY REPLACES ALL OTHER ORAL OR WRITTEN WARRANTIES, LIABILITIES OR OBLIGATIONS OF CERTAINTEED. PERTINENT STATE LAW SHALL CONTROL FOR WHAT PERIOD OF TIME SUBSEQUENT TO SALE A CONSUMER/HOMEOWNER MAY SEEK A REMEDY PURSUANT TO THE IMPLIED WARRANTY OF MERCHANTABILITY OR FITNESS FOR A PARTICULAR PURPOSE. IN NO EVENT SHALL CERTAINTEED BE LIABLE FOR CONSEQUENTIAL OR INCIDENTAL DAMAGES OF ANY KIND, INCLUDING ANY DAMAGE TO THE BUILDING, ITS CONTENTS OR ANY PERSONS THEREIN, RESULTING FROM THE BREACH OF ANY WARRANTY SET FORTH HEREIN. CERTAINTEED DOES NOT AUTHORIZE ITS REPRESENTATIVES, DISTRIBUTORS OR DEALERS TO MAKE ANY CHANGE OR MODIFICATION TO THIS WARRANTY. SOME STATES DO NOT ALLOW LIMITATIONS ON OR THE EXCLUSION OF INCIDENTAL OR CONSEQUENTIAL DAMAGES, SO THE ABOVE EXCLUSIONS MAY NOT APPLY TO YOU.

This warranty gives you specific legal rights, and you may also have other rights that vary from state to state.

Return of the warranty registration card is not required as a condition of warranty coverage.

Organic Shingles

Organic shingles have a thick, **organic felt base reinforcement**. In the manufacturing process, the felt is saturated with a soft, flexible asphalt. It is then completely coated on both sides with tougher coating asphalt and then covered with granules. The result is a **tough, durable shingle with excellent durability in extreme cold weather and good performance characteristics in extreme heat.**

Organic shingles carry a **Class C** fire-resistance rating from Underwriters Laboratories.

Characteristics that equate to high or low **quality** in an organic base shingle include **tear strength, flexibility and cold weather handling.**

ASTM does not provide a standard test for tear strength in organic shingles. Nevertheless, a good organic shingle with tear strength well over 2,000 grams typically will demonstrate excellent cold weather, high wind performance.

One measure of the flexibility of a shingle is an **“Uplift Flexibility”** test, in which the shingle is bent in the same direction as it would be by the action of the wind. The load required to bend the shingle through a range of angles up to 90 degrees is recorded and used to calculate the flexibility index expressed as a percentage. A **good organic shingle will have a flexibility index of 50% or greater.** A high value is one indication of a shingle’s toughness, its resistance to blow-off and damage in handling, and its ability to resist cracking as it ages in service on the roof.

All of CertainTeed’s organic-base asphalt shingles demonstrate tear strength well over 2,000 grams, and uplift flexibility indexes greater than 50%.

WHAT IS A “SHANGLE®”?

The “Shangle®,” an idea conceived by CertainTeed over 30 years ago, is the original “laminated shingle.” The Shangle features a full-size, one-piece shingle as a base, to which individual shingle tabs or overlay pads are applied, providing extra protection and aesthetic enhancement to the roof.

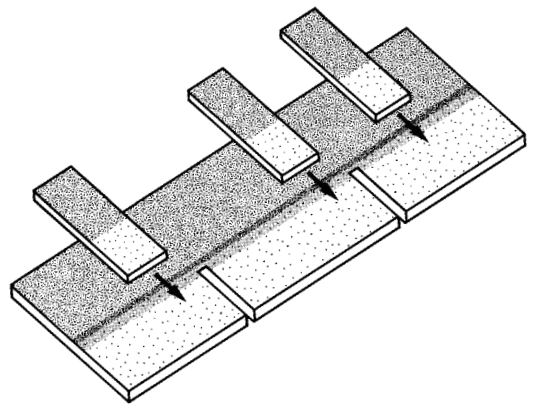

WHAT IS A TWO-PIECE LAMINATE?

Whereas a Shangle consists of a full-size, one-piece base shingle onto which tabs or pads are applied, a two-piece laminate uses a full-size shingle with tab-size teeth cut out of it. Adhered to the back of this top shingle is a half shingle that runs behind the cutouts. The result is a multi-layered shingle that provides a rugged, textured look on the roof.

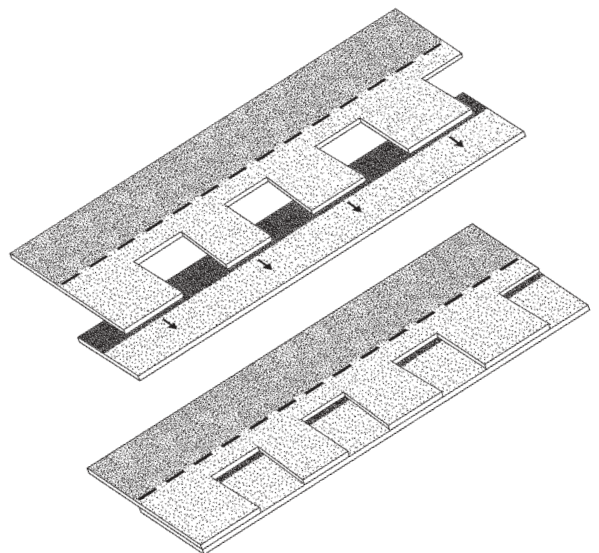

LIMITED WARRANTY

This warranty covers asphalt shingle products sold only in the United States of America, its territories and Canada.

What and Who Is Covered and for How Long

Provided shingles have been installed in strict accordance with CertainTeed written installation instructions, CertainTeed warrants to the original property owner/consumer that its asphalt roofing shingles will be free from manufacturing defects for the length of time specified in the chart below, and that CertainTeed will repair or replace any shingles proven to be defective under the terms of this warranty.

In addition, CertainTeed warrants that Landmark™ XL, Landmark™, Highlands™ Shingle® and FungusBuster® 25 shingles that were sold as “algae-resistant shingles” will remain free from algae and fungus growth which adversely affect the overall appearance of said shingles for a period of ten (10) years. However, CertainTeed reserves the right to clean the fungus or algae stains from the shingles rather than repair or replace the contaminated shingles.

In the event of repair, replacement or cleaning pursuant to the terms of this warranty, the warranty on the replaced, repaired or cleaned shingles will extend for the balance of the warranty period in effect at the time the shingles prove defective.

PRODUCT	WARRANTY PERIOD	SURESTART™ PERIOD	MAXIMUM MATERIAL LIABILITY AFTER SURESTART PERIOD	REDUCTION FIGURE PER MONTH
INDEPENDENCE SHANGLE®	40 YEARS	5 YEARS	\$55/Square	1/480
LANDMARK™ XL (and AR)	40 YEARS	5 YEARS	\$55/Square	1/480
HALLMARK SHANGLE®	30 YEARS	5 YEARS	\$55/Square	1/360
LANDMARK™ (and AR)	30 YEARS	5 YEARS	\$45/Square	1/360
CUSTOM SEALDON® 30	30 YEARS	5 YEARS	\$35/Square	1/360
XT™ 30	30 YEARS	5 YEARS	\$35/Square	1/360
CLASSIC HORIZON SHANGLE®	25 YEARS	5 YEARS	\$40/Square	1/300
LANDMARK™ 25	25 YEARS	5 YEARS	\$40/Square	1/300
NEW HORIZON SHANGLE®	25 YEARS	5 YEARS	\$40/Square	1/300
HIGHLANDS™ SHANGLE® AR	25 YEARS	5 YEARS	\$40/Square	1/300
HEARTHSTEAD® 25	25 YEARS	5 YEARS	\$35/Square	1/300
CUSTOM LOK™ 25	25 YEARS	5 YEARS	\$35/Square	1/300
SOLID SLAB™	25 YEARS	5 YEARS	\$35/Square	1/300
FUNGUSBUSTER® 25	25 YEARS	5 YEARS	\$30/Square	1/300
XT™ 25	25 YEARS	5 YEARS	\$30/Square	1/300
SEALDON® 25	25 YEARS	5 YEARS	\$30/Square	1/300
CERTAINTEED 20	20 YEARS	3 YEARS	\$25/Square	1/240
ANY SHINGLES APPLIED TO UNVENTILATED, INSULATED ROOF DECKS	10 YEARS	N/A	See above	1/120
ALGAE-RESISTANT SHINGLES	10 YEARS	5 YEARS	See above	1/120

SureStart™ Protection

All of CertainTeed’s shingle products are covered by SureStart™ protection for the period specified in the chart above. Under this warranty feature, CertainTeed, at no charge, will repair, replace, or clean, at its option, any shingles proven to be defective during the applicable SureStart period (the SureStart period begins when shingle application has been completed and terminates at the end of the year indicated as its term of duration; i.e., the SureStart period for Independence Shangle terminates at the completion of its fifth year of service).

CertainTeed’s maximum liability under SureStart will be equal to the reasonable cost to replace the defective shingles, plus labor. CertainTeed shall not be responsible or liable for costs of roof tear-off and disposal and of flashing and metal work (and repairs required by defects therein).

(PLEASE REFER TO NEXT TWO PAGES FOR REMAINDER OF WARRANTY, INCLUDING OTHER CONDITIONS.)

SureStart protection does not extend to any shingles applied to insulated roof deck systems that are not ventilated between the insulation and the deck material upon which the shingles are attached. In the case of these shingles, CertainTeed's maximum contribution toward the cost of repairing, replacing or cleaning the defective shingles will be calculated using the figure indicated in the chart on the previous page as the maximum liability, exclusive of costs of labor, roof tear-off and disposal, and by then decreasing that amount by the reduction figure specified in the chart for each month as measured from the date the shingles were installed to the date when proven defective.

In instances in which CertainTeed, under the terms of this warranty, has agreed to pay the cost of labor required to repair, replace or clean defective or contaminated shingles, CertainTeed will provide reimbursement only upon receipt of a copy of the contractor's invoice or other written evidence of the completion of such work which CertainTeed, in its sole discretion, deems acceptable.

Beyond SureStart™ Protection

Should any shingles prove to be defective subsequent to the SureStart™ period, CertainTeed's maximum contribution toward the cost of repairing or replacing the defective shingles will be calculated using the figure indicated in the chart on the previous page as the maximum liability, exclusive of costs of labor, roof tear-off and disposal, and then decreasing that amount by the specified reduction figure based on months of service measured from the date the shingles were installed to the date when proven defective.

Transferability

DURING THE SURESTART PERIOD

The warranty for all of CertainTeed's shingle products may be transferred by the original consumer to the subsequent property owner. If the warranty is transferred by the original consumer during the SureStart period, the duration of the warranty, measured from the date of installation, will remain the same as for the original consumer, and the remaining period of SureStart protection will be available to the subsequent property owner.

AFTER THE SURESTART PERIOD

In the event that the warranty is transferred by the original consumer subsequent to the SureStart period, the warranty duration following the transfer will be two years from the date of real estate title transfer.

Limitations

This warranty provides protection against any shingle defects that arise in the course of ordinary and everyday wear and tear to the roof caused by normal exposure to the elements. It does not provide protection against damage caused by situations and events beyond normal exposure conditions, such as, but not limited to:

- winds, including gusts, greater than 60 miles per hour, lightning, hurricane, tornado, hailstorm, earthquake, fire, explosion, flood or falling objects.
- distortion, cracking or other failure of the base material over which the shingles are applied, or of the roof deck, or of the walls or foundation of the building itself.
- damage caused by structural changes, alterations or additions, or by the installation of equipment (such as aerials, signs or air-conditioning equipment) to the structure after the original shingles have been applied.
- stains or contamination to the shingle arising from sources such as, but not limited to, moss, lichens or other vegetation, or paints, chemicals or other similar materials, unless the applied asphalt shingle was sold as an "algae- or fungus-resistant shingle," in which case CertainTeed will clean, repair or replace, at its option, per the terms of the warranty, only such shingles which are proven to be contaminated with fungus or algae during the term of the warranty against fungus and algae growth.

If the applied shingles contain self-sealing asphalt strips, and if any of these strips fail to activate within the first year following application, CertainTeed shall have no liability under this warranty for such a defect unless CertainTeed is afforded the opportunity to hand-seal, at its sole expense, any non-sealing shingles.

WARRANTY PROTECTION AGAINST FUNGUS



In the East Coast sales region, several of CertainTeed's fiber glass shingles are available in an algae-resistant version. Commonly called "fungus," the black and green algae that creates unsightly streaking on shingles is a common occurrence in warm, humid climates.

CertainTeed provides exceptional warranty protection against fungus and algae contamination. Landmark™ XL AR, Landmark™ AR, Highlands™ Shingle® AR and FungusBuster® 25 carry a 10-year limited warranty against algae growth.

ASPHALT SHINGLES FIBER GLASS AND ORGANIC

As you may know, there are two basic types of asphalt shingles. Each consists of a core material that is coated with asphalt, and then covered with granules. This core, or base material, may

be either fiber glass mat or organic felt. Shingles made of each type of base material possess specific characteristics and attributes that recommend them for particular situations.

Fiber Glass Shingles

Fiber glass shingles carry a **Class A** fire-resistance rating from Underwriters Laboratories (UL), **the highest fire rating available**. Thus, fiber glass shingles are the best protection against the spread of flame on a roof.

Fiber glass shingles are so called because they are built on a core, or mat, of **fiber glass reinforcement**. Asphalt coating is applied directly to this mat, and protective, colored granules are embedded into the coating. Since the mat does not need to be saturated with asphalt, fiber glass shingles are **lighter in weight** than organic shingles and are more resistant to heat and humidity. Perhaps the most important factor that influences the quality of fiber glass shingle performance is the **quality of the mat** used in the construction of the shingle. Throughout the roofing industry, the quality of fiber glass mats varies widely.

The American Society for Testing and Materials (ASTM) has established a standard of performance for fiber glass shingles, **ASTM D3462**, "Standard Specification for Fiber Glass Asphalt Shingles." This test measures the force, in grams, required to tear a shingle in a specialized measuring device known as the "Elmendorf Tear Tester." As measured this way, the **minimum tear strength required by ASTM is 1700 grams**. In repeated tests conducted regularly by CertainTeed and by independent testing laboratories, **all CertainTeed fiber glass shingles have consistently demonstrated the best tear strength rating, and have never failed to comply with all of the requirements of ASTM D3462. This performance is certified by Underwriters Laboratories.**

No other fiber glass shingle manufacturer can make, and substantiate, all these claims.

ROOFING PLANTS AND REGIONAL SALES OFFICES

CertainTeed roofing products are sold by the Roofing Products Group of CertainTeed Corporation. They are manufactured in three roofing plants and sold in three sales regions, as well as special product areas (SPA).

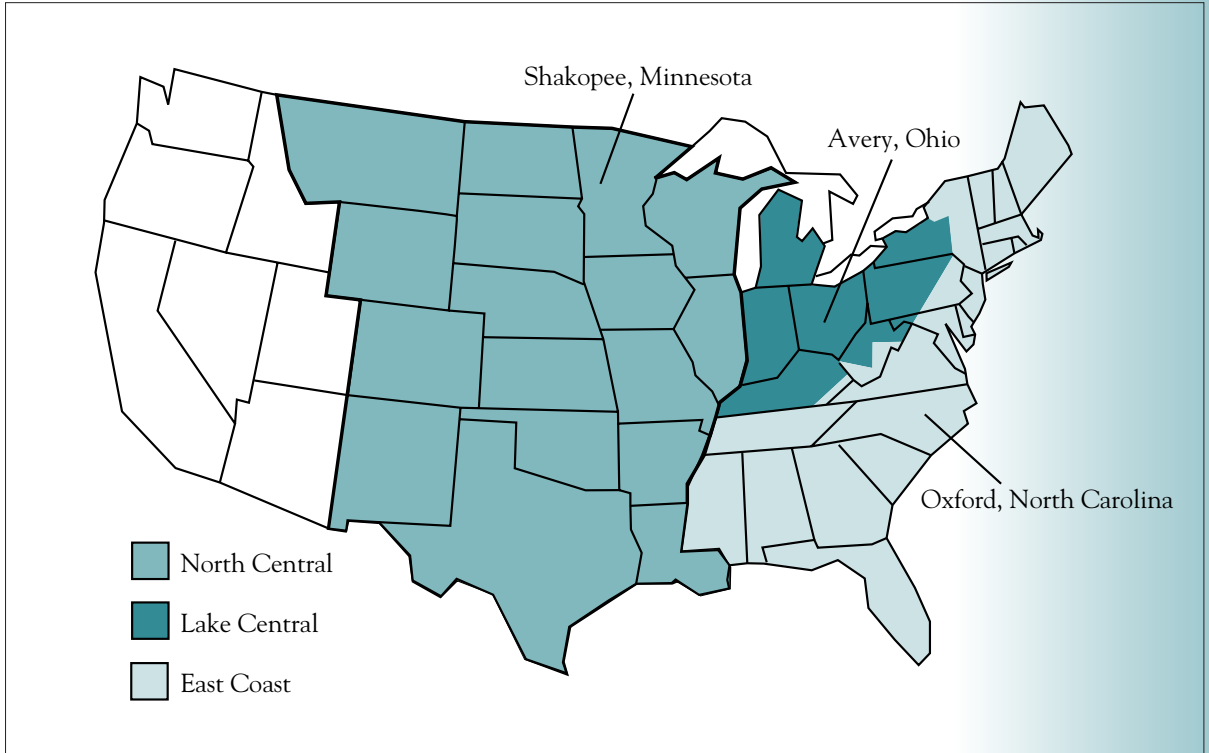

Since the early 1900s, CertainTeed has been an innovator in the building materials industry, today producing and selling vinyl windows, vinyl siding and accessories, asphalt roofing shingles, roof ventilation products, clay roof tiles, fiber glass insulation and reinforcements, and PVC pipe at more than 100 facilities nationwide. Continuing the 90-year commitment of “quality made *certain*, satisfaction guaranteed,” CertainTeed remains one of the most trusted names in the industry.

CertainTeed Corporation
Roofing Products Group
P.O. Box 860
Valley Forge, PA 19482
800-345-1145

CertainTeed 
Quality made certain. Satisfaction guaranteed.

ASPHALT SHINGLE PRODUCTS LIMITED WARRANTY

CONGRATULATIONS!

... and thank you for your recent purchase of one of the fine products in the CertainTeed Roofing Collection™. Since 1904, CertainTeed has been producing quality roofing products that provide long-lasting beauty and protection for homes of every size, style and age. For the past 90 years, the basis for our name, “Quality made certain, satisfaction guaranteed,” has been our ongoing philosophy.

Your CertainTeed roofing warranty fully explains how CertainTeed supports its products with the strongest warranty protection available. In the following paragraphs we would like to highlight some of the more important warranty features, and provide some additional information that will help you understand why the quality of your CertainTeed roof is not just a claim, but a fact.

However, it is important that you read the warranty section of this brochure. The warranty lists the specific CertainTeed asphalt shingle products that are covered and the period of time for which they are covered. Take the time to understand how CertainTeed protects your purchase by standing behind our products.

SURESTART™ PROTECTION

Because CertainTeed roofing products are manufactured to the highest quality standards, we confidently include the additional assurance of SureStart™ protection with all CertainTeed shingles. SureStart provides the strongest protection you can get in the vital early years after your new roof has been installed.

Simply put, if a manufacturing defect is discovered during the SureStart period, CertainTeed will provide reimbursement of 100% of the cost of the shingles and labor to repair the defective shingles or apply new shingles to replace the defective shingles (exclusive of costs of tear-off and flashings). SureStart protection is not prorated or otherwise reduced over time.

SureStart protection does not extend to any shingles applied to insulated roof deck systems that have not been ventilated between the insulation and the deck.

SURESTART™ PLUS PROTECTION

FIVE ADDITIONAL YEARS OF SURESTART™ WARRANTY PROTECTION AND FIVE-YEAR EXTENSION OF THE LIMITED WIND WARRANTY

For an added measure of assurance, SureStart PLUS™ warranty protection extends the duration of both SureStart protection and of the limited wind warranty for an additional five years. All the same provisions, conditions and limitations that apply to SureStart and the initial limited wind warranty apply to SureStart PLUS coverage.

SureStart PLUS coverage may be obtained through your roofing contractor under the following conditions:

1. The consumer must pay a fee to CertainTeed of \$2.00 per square of qualifying CertainTeed shingles installed on the roof.
2. The roof system must meet the standards of CertainTeed's Integrity Roof System™.
3. The roof system must have been installed by a contractor who, at the time of the roof installation, holds credentials as a CertainTeed SELECT Shingle RooferSM.

The CertainTeed Integrity Roof System must incorporate all of the following components:

1. CertainTeed shingles carrying a warranty duration of at least 25 years and installed according to the instructions in the CertainTeed Shingle Applicator's Manual.

2. Unless a specific exception has been granted in advance by CertainTeed, Air Vent Inc. attic ventilation products or CertainTeed soffit and eave ventilation products installed: (a) to meet applicable model code requirements or HUD/FHA minimum property standards for attic ventilation: (b) according to manufacturer's installation instructions applicable to the roof system at the time of installation: (c) in accordance with CertainTeed's warranty requirements for attic ventilation.
3. Underlayment installed in accordance with installation instructions published in the CertainTeed Shingle Applicator's Manual. Underlayment must be manufactured by CertainTeed when geographically available or, it must meet standards of performance set forth by ASTM Standard D4869 or D229 (unperforated).
4. In areas in or north of the following states – Virginia, Kentucky, Missouri, Kansas, Colorado, Utah, Nevada and Oregon – CertainTeed's WinterGuard™ waterproofing shingle underlayment installed at the roof eaves and in the valleys according to instructions in the CertainTeed Shingle Applicator's Manual.

A CertainTeed SELECT Shingle Roofer is a contractor who has qualified for inclusion in this exclusive program by virtue of having completed specific professional and educational programs, and by carrying the requisite amount of both liability insurance and workers' compensation insurance. Your Select Shingle Roofer can provide complete details about the Integrity Roof System and how to apply for SureStart PLUS warranty protection.

TRANSFERABILITY

The warranties for CertainTeed shingles are transferable by the original property owner to the subsequent owner. Upon transfer of the warranty during the product's SureStart or SureStart PLUS periods, the remaining duration of the warranty for the new owner is the same as it would have been for the original owner.

And, the remaining period of SureStart or SureStart PLUS protection will be available to the subsequent property owner.

For product warranties transferred after the SureStart or SureStart PLUS period has elapsed, the remaining duration of the transferred warranty will be two years from the date of real estate title transfer.

WARRANTY PROTECTION AGAINST FUNGUS

In the East Coast sales region, several of CertainTeed's fiber glass shingles are available in an algae-resistant version. Commonly called "fungus," the black and green algae that creates unsightly streaking on shingles is a common occurrence in warm, humid climates. CertainTeed provides exceptional warranty protection against fungus and algae contamination. Landmark™ 40 AR, Landmark™ 30 AR, Highlands Shangle™ AR and FungusBuster® 25 carry a 10-year limited warranty against algae growth.

WHAT IS A "SHANGLE®" ?

The "Shangle®," an idea conceived by CertainTeed over 30 years ago, is the original "laminated shingle." The Shangle features a full-size, one-piece shingle as a base, to which individual shingle tabs or overlay pads are applied, providing extra protection and aesthetic enhancement to the roof.

WHAT IS A TWO-PIECE LAMINATE?

Whereas a Shangle consists of a full-size, one-piece base shingle onto which tabs or pads are applied, a two-piece laminate uses a full-size shingle with tab-size teeth cut out of it. Adhered to the back of this top shingle is a half shingle that runs behind the cutouts. The result is a multi-layered shingle that provides a rugged, textured look on the roof.

LIMITED WARRANTY

THIS WARRANTY COVERS ASPHALT SHINGLE PRODUCTS SOLD ONLY IN THE UNITED STATES OF AMERICA, ITS TERRITORIES AND CANADA.

Provided shingles have been installed in strict accordance with CertainTeed current written installation instructions, CertainTeed warrants to the original property owner/consumer that its asphalt roofing shingles will be free from manufacturing defects for the length of time specified in the chart below, and that CertainTeed will repair or replace any shingles proven to be defective under the terms of this warranty. In addition, CertainTeed warrants that Landmark™ 40, Landmark™ 30, Highlands Shingle™ and FungusBuster® 25 shingles that were sold as “algae-resistant shingles” will remain free from algae and fungus growth which adversely affect the overall appearance of said shingles for a period of ten (10) years. However, CertainTeed reserves the right to clean the fungus or algae stains from the shingles rather than repair or replace the contaminated shingles.

In the event of repair, replacement or cleaning pursuant to the terms of this warranty, the warranty on the replaced, repaired or cleaned shingles will extend for the balance of the warranty period in effect at the time the shingles prove defective.

PRODUCT	WARRANTY PERIOD	SURESTART™ PERIOD	MAXIMUM MATERIAL LIABILITY AFTER SURESTART PERIOD	REDUCTION FIGURE PER MONTH
Independence Shingle®	40 YEARS	5 YEARS	\$55/Square	1/480
Landmark™ 40 (and AR)	40 YEARS	5 YEARS	\$55/Square	1/480
Hallmark Shingle®	30 YEARS	5 YEARS	\$55/Square	1/360
Landmark™ 30 (and AR)	30 YEARS	5 YEARS	\$45/Square	1/360
Custom Sealdon® 30	30 YEARS	5 YEARS	\$35/Square	1/360
XT™ 30	30 YEARS	5 YEARS	\$35/Square	1/360
Landmark™ 25	25 YEARS	5 YEARS	\$40/Square	1/300
Classic Horizon Shingle®	25 YEARS	5 YEARS	\$40/Square	1/300
New Horizon Shingle®	25 YEARS	5 YEARS	\$40/Square	1/300
Highlands Shingle™ AR	25 YEARS	5 YEARS	\$40/Square	1/300
Hearthstead® 25	25 YEARS	5 YEARS	\$35/Square	1/300
Custom Lok™ 25	25 YEARS	5 YEARS	\$35/Square	1/300
Solid Slab™	25 YEARS	5 YEARS	\$35/Square	1/300
FungusBuster® 25	25 YEARS	5 YEARS	\$30/Square	1/300
XT™ 25	25 YEARS	5 YEARS	\$30/Square	1/300
Sealdon® 25	25 YEARS	5 YEARS	\$30/Square	1/300
CT 20	20 YEARS	3 YEARS	\$25/Square	1/240
Any Shingle applied to Unventilated, Insulated Roof Decks	10 YEARS	N/A	See above	1/120
Algae-Resistant Shingle	10 YEARS	5 YEARS	See above	1/120

SURESTART™ PROTECTION

All of CertainTeed’s shingle products are covered by SureStart™ protection for the period specified in the chart above. Under this warranty feature, CertainTeed, at no charge, will repair, replace, or clean, at its option, any shingles proven to be defective during the applicable SureStart period (the SureStart period begins when shingle application has been completed and terminates at the end of the year indicated as its term of duration; i.e., the SureStart period for Independence Shingle terminates at the completion of its fifth year of service). CertainTeed’s maximum liability under SureStart will be equal to the reasonable cost to replace the defective shingles, plus labor. CertainTeed shall not be responsible or liable for costs of roof tear-off and disposal and of flashing and metal work (and repairs required by defects therein).

SureStart protection does not extend to any shingles applied to insulated roof deck systems that are not ventilated between the insulation and the deck material upon which the shingles are attached. In the case

of these shingles, CertainTeed's maximum contribution toward the cost of repairing, replacing or cleaning the defective shingles will be calculated using the figure indicated in the chart on the previous page as the maximum liability, exclusive of costs of labor, roof tear-off and disposal, and by then decreasing that amount by the reduction figure specified in the chart for each month as measured from the date the shingles were installed to the date when proven defective.

In instances in which CertainTeed, under the terms of this warranty, has agreed to pay the cost of labor required to repair, replace or clean defective or contaminated shingles, CertainTeed will provide reimbursement only upon receipt of a copy of the contractor's invoice or other written evidence of the completion of such work which CertainTeed, in its sole discretion, deems acceptable.

SURESTART™ PLUS PROTECTION

Under SureStart™ PLUS warranty protection, which may be purchased under specific conditions and for a specified fee, CertainTeed will repair or replace, at its option, any shingles proven to be defective during the additional five-year period subsequent to the SureStart protection period applicable to the particular shingle product. In no event shall the total duration of the initial SureStart protection and SureStart PLUS protection exceed ten (10) years. Under SureStart PLUS coverage, CertainTeed also warrants its shingles to resist blow-off damage due to wind velocities, including gusts, up to 60 miles per hour for the additional five-year period subsequent to the five-year limited wind warranty which is applicable to each CertainTeed shingle product.

All provisions of the SureStart feature and of the initial limited wind warranty, as set forth herein, shall apply to SureStart PLUS coverage

BEYOND SURESTART™ OR SURESTART™ PLUS PROTECTION

Should any shingles prove to be defective subsequent to the SureStart™ or SureStart™ PLUS period, CertainTeed's maximum contribution toward the cost of repairing or replacing the defective shingles will be calculated using the figure indicated in the chart on the previous page as the maximum liability, exclusive of costs of labor, roof tear-off and disposal, and then decreasing that amount by the specified reduction figure based on months of service measured from the date the shingles were installed to the date when proven defective.

TRANSFERABILITY

During The SureStart or SureStart Plus Period The warranty for all of CertainTeed's shingle products may be transferred by the original consumer to the subsequent property owner. If the warranty is transferred by the original consumer during the SureStart or SureStart PLUS periods, the duration of the warranty, measured from the date of installation, will remain the same as for the original consumer, and the remaining period of SureStart or SureStart PLUS protection will be available to the subsequent property owner.

After The SureStart or SureStart Plus Period In the event that the warranty is transferred by the original consumer subsequent to the SureStart or SureStart PLUS period, the warranty duration following the transfer will be two years from the date of real estate title transfer.

LIMITATIONS

This warranty provides protection against any shingle defects that arise in the course of ordinary and everyday wear and tear to the roof caused by normal exposure to the elements. It does not provide protection against damage caused by situations and events beyond normal exposure conditions, such as, but not limited to:

- winds, including gusts, greater than 60 miles per hour, lightning, hurricane, tornado, hailstorm, earthquake, fire, explosion, flood or falling objects.
- distortion, cracking or other failure of the base material over which the shingles are applied, or of the roof deck, or of the walls or foundation of the building itself.

- damage caused by structural changes, alterations or additions, or by the installation of equipment (such as aerials, signs or air-conditioning equipment) to the structure after the original shingles have been applied.
- stains or contamination to the shingle arising from sources such as, but not limited to, moss, lichens or other vegetation, or paints, chemicals or other similar materials, unless the applied asphalt shingle was sold as an “algae- or fungus-resistant shingle,” in which case CertainTeed will clean, repair or replace, at its option, per the terms of the warranty, only such shingles which are proven to be contaminated with fungus or algae during the term of the warranty against fungus and algae growth.

If the applied shingles contain self-sealing asphalt strips, and if any of these strips fail to activate within the first year following application, CertainTeed shall have no liability under this warranty for such a defect unless CertainTeed is afforded the opportunity to hand-seal, at its sole expense, any non-sealing shingles. CertainTeed limits its warranty protection to a ten (10) year duration (from date of completion of shingle application to the end of the tenth year of service) for shingles applied to insulated roof deck systems that have not been ventilated between the deck material and the insulation. This warranty obligation is subject to the maximum material liability shown on the chart on page 5 and is reduced by the reduction figure shown on that chart.

CertainTeed reserves the right to discontinue or modify any of its products, including the color of the shingles, and shall not be liable as a result of such discontinuance or modification, nor shall CertainTeed be liable in the event replacement material may vary in color in comparison to the original product as a result of normal weathering. If CertainTeed replaces any material under this warranty, it may substitute products designated by CertainTeed to be of comparable quality or price range in the event the product initially installed has been discontinued or modified.

LIMITED WIND WARRANTY

CertainTeed warrants both its fiber glass asphalt shingles and its organic-base asphalt shingles to resist blow-off damage due to wind velocities, including gusts, up to 60 miles per hour during the initial five-year period following application of the shingles. If any such blow-off damage does occur during the first five years after application, CertainTeed will furnish replacement shingles without charge for those shingles damaged (but will not be responsible for labor costs pertaining to removal or replacement of damaged shingles). However, in the event the shingles involved contain self-sealing asphalt strips, CertainTeed shall have no liability under this Limited Wind Warranty unless it is first afforded the opportunity to hand-seal, at its sole expense, any non-sealing asphalt strips which fail to activate within the first year after application.

Any costs in excess of CertainTeed’s contribution shall be the owner’s responsibility through homeowner’s insurance, etc.

WHAT THE CUSTOMER MUST DO

The property owner must promptly notify CertainTeed in writing of any manufacturing defect or fungus or algae contamination and provide proof of the date of purchase and date of application of the shingles. CertainTeed will then investigate the claim, and if a defect covered by this warranty is confirmed, CertainTeed, within a reasonable amount of time after the inspection, will repair, replace or clean the defective shingles or reimburse the property owner the appropriate amount for the repair, replacement or cleaning of the shingles under the terms of the warranty.

Notification should be sent to:

CertainTeed Corporation
1400 Union Meeting Road
Blue Bell, PA 19422
Attn: RPG Consumer Service Dept.

This warranty, which is effective on shingles applied on or after January 1, 1998, supersedes that written warranty previously issued by CertainTeed coded No. 20-20-1171.

THIS WARRANTY REPLACES ALL OTHER ORAL OR WRITTEN WARRANTIES, LIABILITIES OR OBLIGATIONS OF CERTAINTEED. PERTINENT STATE LAW SHALL CONTROL FOR WHAT PERIOD OF TIME SUBSEQUENT TO SALE A CONSUMER/HOMEOWNER MAY SEEK A REMEDY PURSUANT TO THE IMPLIED WARRANTY OF MERCHANTABILITY OR FITNESS FOR A PARTICULAR PURPOSE. IN NO EVENT SHALL CERTAINTEED BE LIABLE FOR CONSEQUENTIAL OR INCIDENTAL DAMAGES OF ANY KIND, INCLUDING ANY DAMAGE TO THE BUILDING, ITS CONTENTS OR ANY PERSONS THEREIN, RESULTING FROM THE BREACH OF ANY WARRANTY SET FORTH HEREIN. CERTAINTEED DOES NOT AUTHORIZE ITS REPRESENTATIVES, DISTRIBUTORS OR DEALERS TO MAKE ANY CHANGE OR MODIFICATION TO THIS WARRANTY. SOME STATES DO NOT ALLOW LIMITATIONS ON OR THE EXCLUSION OF INCIDENTAL OR CONSEQUENTIAL DAMAGES, SO THE ABOVE EXCLUSIONS MAY NOT APPLY TO YOU.

Return of the warranty registration card is not required as a condition of warranty coverage.state to state.

**CertainTeed Corporation
Roofing Products Group
Attn: Marketing Department
P.O. Box 860
Valley Forge, PA 19482**

Return of the warranty registration card is not required as a condition of warranty coverage.

ROOFING PLANTS AND REGIONAL SALES OFFICES

CertainTeed roofing products are sold by the Roofing Products Group of CertainTeed Corporation. They are manufactured in three roofing plants and sold in three sales regions, as well as special product areas (SPA).

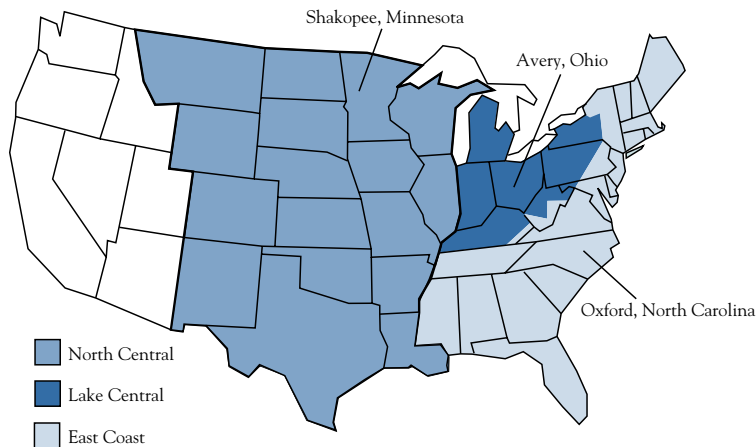

Since the early 1900s, CertainTeed has been an innovator in the building materials industry, today producing and selling vinyl windows, vinyl siding and accessories, vinyl fence and railing, asphalt roofing shingles, roof ventilation products, clay roof tiles, fiber glass insulation and reinforcements, foundation products, and PVC pipe at more than 100 facilities nationwide. Continuing the 90-year commitment of “quality made certain, satisfaction guaranteed,” CertainTeed remains one of the most trusted names in the industry.

**CertainTeed Corporation
Roofing Products Group
P.O. Box 860
Valley Forge, PA 19482
800-345-1145**

ASPHALT SHINGLE PRODUCTS
CERTAINTEED CORPORATION



CertainTeed 



LIMITED

WARRANTY

CONGRATULATIONS!

... and thank you for your recent purchase of one of the fine products in the CertainTeed Roofing Collection™. Since 1904, CertainTeed has been producing quality roofing products that provide long-lasting beauty and protection for homes of every size, style and age. For the past 90 years, the basis for our name, “Quality made certain, satisfaction guaranteed,” has been our ongoing philosophy.

Your CertainTeed roofing warranty fully explains how CertainTeed supports its products with the strongest warranty protection available. In the following paragraphs we would like to highlight some of the more important warranty features, and provide some additional information that will help you understand why the quality of your CertainTeed roof is not just a claim, but a fact.

However, it is important that you read the warranty section of this brochure. The warranty lists the specific CertainTeed asphalt shingle products that are covered and the period of time for which they are covered. Take the time to understand how CertainTeed protects your purchase by standing behind our products.

SURESTART™ PROTECTION

Because CertainTeed roofing products are manufactured to the highest quality standards, we confidently include the additional assurance of SureStart™ protection with all CertainTeed shingles. SureStart provides the strongest protection you can get in the vital early years after your new roof has been installed.

Simply put, if a manufacturing defect is discovered during the SureStart period, CertainTeed will provide reimbursement of 100% of the cost of the shingles and labor to repair the defective shingles or apply new shingles to



replace the defective shingles (exclusive of costs of tear-off, metal work and disposal). SureStart protection is not prorated or otherwise reduced over time.

SureStart protection does not extend to any shingles applied to insulated roof deck systems that have not been ventilated between the insulation and the deck.

SURESTART™ PLUS PROTECTION

Additional Years of SureStart™ Warranty Protection And an Extension of the Limited Wind Warranty

For an added measure of assurance, SureStart™ PLUS warranty protection extends the duration of both SureStart protection and the limited wind warranty up to a total of ten years. All the same provisions, conditions and limitations that apply to SureStart and the initial limited wind warranty apply to SureStart PLUS coverage.

SureStart PLUS coverage may be obtained through your roofing contractor under the following conditions:

1. The consumer must pay a specified fee to CertainTeed.
2. The roof system must meet the standards of CertainTeed's Integrity Roof System™.

3. The roof system must have been installed by a contractor who, at the time of the roof installation, holds credentials as a CertainTeed SELECT Shingle RooferSM.

The CertainTeed Integrity Roof System must incorporate all of the following components:

1. CertainTeed shingles carrying a warranty duration of at least 25 years and installed according to the instructions in the CertainTeed Shingle Applicator's Manual.
2. Unless a specific exception has been granted in advance by CertainTeed, Air Vent Inc. attic ventilation products or CertainTeed soffit and eaves ventilation products installed: (a) to meet applicable model code requirements or HUD/FHA minimum property standards for attic ventilation; (b) according to manufacturer's installation instructions applicable to the roof system at the time of installation; (c) in accordance with CertainTeed's shingle warranty requirements for attic ventilation.
3. Underlayment installed in accordance with installation instructions published in

the CertainTeed Shingle Applicator's Manual. Underlayment must be manufactured by CertainTeed where geographically available, or it must meet standards of performance set forth by ASTM Standard D4869 or D229 (unperforated).

4. In areas in or north of the following states – Virginia, Kentucky, Missouri, Kansas, Colorado, Utah, Nevada and Oregon – CertainTeed's WinterGuardSM waterproofing shingle underlayment installed at the roof eaves and in the valleys according to instructions in the CertainTeed Shingle Applicator's Manual.

A CertainTeed SELECT Shingle Roofer is a contractor who has qualified for inclusion in this exclusive program by virtue of having completed specific professional and educational programs, and by carrying the requisite amount of both liability insurance and workers' compensation insurance. Your SELECT Shingle Roofer can provide complete details about the Integrity Roof System and how to apply for SureStart PLUS warranty protection.

TRANSFERABILITY

The warranty for CertainTeed shingles is transferable by the original property owner to the subsequent owner. Upon transfer of the warranty during the product's SureStart or SureStart PLUS periods, the remaining duration of the warranty for the new owner is the same as it would have been for the original owner.

And, the remaining period of SureStart or SureStart PLUS protection will be available to the subsequent property owner.

For product warranties transferred after the SureStart or SureStart PLUS period has elapsed, the remaining duration of the transferred warranty will be **two** years from the date of real estate title transfer.

WARRANTY PROTECTION AGAINST ALGAE



Several of CertainTeed's fiber glass shingles are available in an algae-resistant version. Commonly called "fungus," the black and green algae that creates unsightly streaking on shingles is a common occurrence in warm, humid climates.

CertainTeed provides exceptional warranty protection against algae contamination. Grand Manor Shingle®, Carriage House Shingle™, Hatteras®, Landmark™ 40 AR, Landmark™ 30 AR, Independence Shingle® AR, Highlands Shingle™ AR and FungusBuster® 25 shingles carry a 10-year limited warranty against algae growth.

WHAT IS A "SHANGLE®"?

The "Shangle®," an idea conceived by CertainTeed over 30 years ago, is the original "laminated shingle." The Shangle features a full-size, one-piece shingle as a base, to which individual shingle tabs or overlay pads are applied, providing extra protection and aesthetic enhancement to the roof.

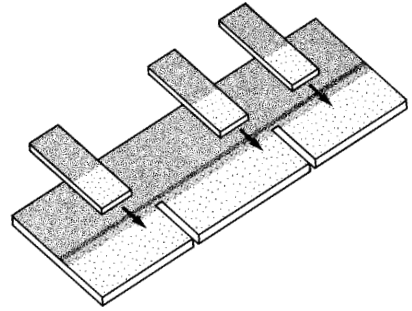

WHAT IS A TWO-PIECE LAMINATE?

Whereas a Shangle consists of a full-size, one-piece base shingle onto which tabs or pads are applied, a two-piece laminate uses a full-size shingle with tab-size teeth cut out of it. Adhered to the back of this top shingle is a half shingle that runs behind the cutouts. The result is a multi-layered shingle that provides a rugged, textured look on the roof.

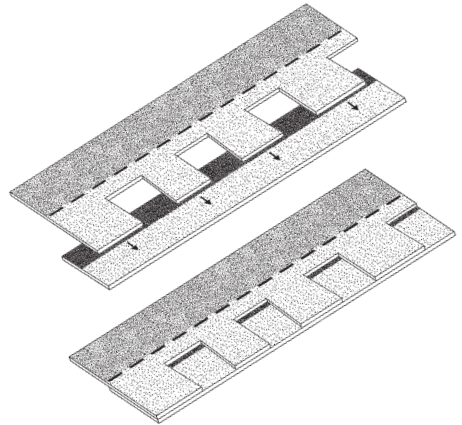

LIMITED WARRANTY

This warranty covers asphalt shingle products sold only in the United States of America, its territories and Canada.

What and Who Is Covered and for How Long

Provided shingles have been installed in strict accordance with CertainTeed current written installation instructions, CertainTeed warrants to the original property owner/consumer that its asphalt roofing shingles will be free from manufacturing defects for the length of time specified in the chart below, and that CertainTeed will repair or replace any shingles proven to be defective under the terms of this warranty.

In addition, CertainTeed warrants that Grand Manor Shingle®, Carriage House Shingle™, Independence Shingle® AR, Hattersas®, Landmark™ 40 AR, Landmark™ 30 AR, Highlands Shingle™ AR and FungusBuster® 25 shingles that were sold as “algae-resistant shingles” will remain free from algae growth which adversely affects the overall appearance of said shingles for a period of ten (10) years. However, CertainTeed reserves the right to clean the algae stains from the shingles rather than repair or replace the contaminated shingles.

In the event of repair, replacement or cleaning pursuant to the terms of this warranty, the original warranty shall apply to the replacement shingles or the repaired or cleaned shingles and will extend for the balance of the warranty period in effect at the time the shingles proved defective.

The lifetime coverage for Grand Manor Shingle and Carriage House Shingle offered by this warranty is designed to cover individual homeowners only. In the instance of shingles purchased by or installed upon property owned by, for example, corporations, governmental agencies, partnerships, trusts, religious organizations, schools, condominiums or cooperative housing arrangements, or installed on apartment buildings or any other type of building or premises not used by individual homeowners as their residence, the warranty period for Grand Manor Shingle and Carriage House Shingle will be 40 years following the installation of the shingles, and in both instances CertainTeed’s maximum liability after the SureStart period will be calculated using the figure indicated in Table 1 as the maximum material liability, exclusive of costs of labor, roof tear-off, metal work, and disposal, and by then decreasing that amount by the reduction figure specified in Table 1 for each month as measured from the date the shingles were installed to the date when proven defective.

TABLE 1

PRODUCT	WARRANTY PERIOD	SURESTART™ PERIOD	MAXIMUM MATERIAL LIABILITY AFTER SURESTART PERIOD	REDUCTION FIGURE PER MONTH
GRAND MANOR SHANGLE®	LIFETIME	10 YEARS	\$140/Square	1/480*
CARRIAGE HOUSE SHANGLE®	LIFETIME	7 YEARS	\$110/Square	1/480*
INDEPENDENCE SHANGLE® (and AR)	40 YEARS	5 YEARS	\$55/Square	1/480
LANDMARK™ 40 (and AR)	40 YEARS	5 YEARS	\$55/Square	1/480
HATTERSAS®	40 YEARS	5 YEARS	\$55/Square	1/480
HALLMARK SHANGLE®	30 YEARS	5 YEARS	\$55/Square	1/360
LANDMARK™ 30 (and AR)	30 YEARS	5 YEARS	\$45/Square	1/360
CUSTOM SEALDON® 30	30 YEARS	5 YEARS	\$35/Square	1/360
XT™ 30	30 YEARS	5 YEARS	\$35/Square	1/360
LANDMARK™ 25	25 YEARS	5 YEARS	\$40/Square	1/300
CLASSIC HORIZON SHANGLE®	25 YEARS	5 YEARS	\$40/Square	1/300
NEW HORIZON SHANGLE®	25 YEARS	5 YEARS	\$40/Square	1/300
HIGHLANDS SHANGLE™ AR	25 YEARS	5 YEARS	\$40/Square	1/300
HEARTHSTEAD® 25	25 YEARS	5 YEARS	\$35/Square	1/300
CUSTOM LOK™ 25	25 YEARS	5 YEARS	\$35/Square	1/300
SOLID SLAB™	25 YEARS	5 YEARS	\$35/Square	1/300
FUNGUSBUSTER® 25	25 YEARS	5 YEARS	\$30/Square	1/300
XT™ 25	25 YEARS	5 YEARS	\$30/Square	1/300
SEALDON® 25	25 YEARS	5 YEARS	\$30/Square	1/300
CT 20	20 YEARS	3 YEARS	\$25/Square	1/240
ANY SHINGLES APPLIED TO UNVENTILATED, INSULATED ROOF DECKS	10 YEARS	N/A	See above	1/120
ALGAE-RESISTANCE	10 YEARS	5 YEARS	See above	1/120

* For Grand Manor Shingle and Carriage House Shingle, at the completion of the 32nd year the reduction figure will remain at 384/480, or 20% of the the total maximum liability.

(PLEASE REFER TO NEXT 2 PAGES FOR REMAINDER OF WARRANTY, INCLUDING OTHER CONDITIONS.)

SureStart™ Protection

All of CertainTeed's shingle products are covered by SureStart™ protection for the period specified in Table 1. Under this warranty feature, CertainTeed, at no charge, will repair or replace, at its option, any shingles proven to be defective during the applicable SureStart period (the SureStart period begins when shingle application has been completed and terminates at the end of the year indicated as its term of duration; i.e., the SureStart period for Independence Shingle terminates at the completion of its fifth year of service). CertainTeed's maximum material liability under SureStart will be equal to the reasonable cost to replace the defective shingles, plus labor. CertainTeed shall not be responsible or liable for costs of roof tear-off and disposal and of flashing and metal work (and repairs required by defects therein) except for Grand Manor Shingle and Carriage House Shingle, for which CertainTeed's maximum liability will also include the cost of roof tear-off and disposal.

SureStart protection does not extend to any shingles applied to insulated roof deck systems that are not ventilated between the insulation and the deck material upon which the shingles are attached. In the case of these shingles, CertainTeed's maximum contribution toward the cost of repairing, replacing or cleaning the defective shingles will be calculated using the figure indicated in Table 1 as the maximum material liability, exclusive of costs of labor, roof tear-off and disposal, and by then decreasing that amount by the reduction figure specified in Table 1 for each month as measured from the date the shingles were installed to the date when proven defective.

In instances in which CertainTeed, under the terms of this warranty, has agreed to pay the cost of labor required to repair, replace or clean defective or contaminated shingles, CertainTeed will provide reimbursement only upon receipt of a copy of the contractor's invoice or other written evidence of the completion of such work which CertainTeed, in its sole discretion, deems acceptable.

SureStart™ PLUS Protection

Under SureStart™ PLUS warranty protection, which may be purchased under specific conditions and for a specified fee (except for Grand Manor Shingle), CertainTeed will repair or replace, at its option, any shingles proven to be defective during the additional five-year period (three years for Carriage House Shingle) subsequent to the SureStart protection period applicable to the particular shingle product. In no event shall the total duration of the initial SureStart protection and SureStart PLUS protection exceed ten (10) years. Under SureStart PLUS coverage, CertainTeed also warrants its shingles to resist blow-off damage due to wind velocities, including gusts, up to 60 miles per hour for an additional five-year period (three years for Carriage House Shingle) subsequent to the five-year limited wind warranty which is applicable to all CertainTeed shingle products with the exception of Grand Manor Shingle, Carriage House Shingle and Hatteras, which carry separate wind warranties (see Limited Wind Warranty).

All provisions of the SureStart feature and of the initial limited wind warranty, as set forth herein, shall apply to SureStart PLUS coverage.

Beyond SureStart™ or SureStart™ PLUS Protection

Should any shingles prove to be defective subsequent to the SureStart™ or SureStart™ PLUS period, CertainTeed's maximum contribution toward the cost of repairing or replacing the defective shingles will be calculated using the figure indicated in Table 1 as the maximum material liability, exclusive of costs of labor, roof tear-off and disposal, and by then decreasing that amount by the specified reduction figure for each month as measured from the date the shingles were installed to the date when proven defective.

Transferability

DURING THE SURESTART OR SURESTART PLUS PERIOD

This limited warranty may be transferred by the original consumer to the subsequent property owner.

With respect to Grand Manor Shingle, if this warranty is effectively transferred during the ten (10) year SureStart period, the duration of the warranty will be 40 years measured from the date of installation, and the remaining period of SureStart protection will be available to the subsequent property owner.

With respect to Carriage House Shingle, if this warranty is effectively transferred during the SureStart or SureStart PLUS periods, the duration of the warranty will be 40 years measured from the date of installation, and the remaining period of SureStart or SureStart PLUS protection will be available to the subsequent property owner.

The lifetime coverage offered by this warranty for Grand Manor Shingle and Carriage House Shingle automatically ceases not only upon sale of the property, but also upon the death of the last of the original owners of the property at the time of installation. In either event, the warranty will cover 40 years and CertainTeed's maximum contribution toward the cost of repairing or replacing the defective shingles will be calculated as explained in the above section titled "Beyond SureStart or SureStart PLUS Protection."

For all other shingle products, if the warranty is transferred by the original consumer during the SureStart or SureStart PLUS periods, the duration of the warranty, measured from the date of installation, will remain the same as for the original consumer, and the remaining period of SureStart or SureStart PLUS protection will be available to the subsequent property owner.

AFTER THE SURESTART OR SURESTART PLUS PERIOD

In the event that the warranty is transferred by the original consumer subsequent to the SureStart or SureStart PLUS period, the warranty duration following the transfer will be two years from the date of real estate title transfer, and the warranty obligation will be calculated as explained in the above section titled "Beyond SureStart and SureStart PLUS Protection."

Limitations

This warranty provides protection against any shingle defects that arise in the course of ordinary and everyday wear and tear to the roof caused by normal exposure to the elements. It does not provide protection against damage caused by situations and events beyond normal exposure conditions, such as, but not limited to:

- winds, including gusts, greater than 60 miles per hour (greater than 110 miles per hour for Hatteras shingles), lightning, hurricane (see Limited Wind Warranty for wind exception), tornado, hailstorm, earthquake, fire, explosion, flood or falling objects.
- distortion, cracking or other failure, or movement of the base material over which the shingles are applied, or of the roof deck, or of the walls or foundation of the building itself.
- damage caused by structural changes, alterations or additions, or by the installation of equipment (such as aerials, signs or air-conditioning equipment) to the structure after the original shingles have been applied.
- stains or contamination to the shingle arising from sources such as, but not limited to, moss, lichens or other vegetation, or paints, chemicals or other similar materials, unless the applied asphalt shingle was sold as an “algae- or fungus-resistant shingle,” in which case CertainTeed will clean, repair or replace, at its option, per the terms of the warranty, only such shingles which are proven to be contaminated with algae during the term of the warranty against algae growth.
- improper storage of CertainTeed shingles.
- installation of shingles over non-approved roof decks as fully explained in the CertainTeed Shingle Applicator’s Manual.
- damage to CertainTeed shingles, the roof deck or the structure caused by ice backup or ice damming.

IMPORTANT: Shingles containing a factory applied self-sealing asphalt strip must be subjected to direct sunlight for several days before sealing will occur. Shingles installed in the fall or winter may not seal until the following spring. Shingles which do not receive direct sunlight or which are not exposed to adequate surface temperatures may never seal and must be hand sealed at time of application. Shingles which have not been properly installed may not seal. Damage to the factory applied self-sealing strip by dust, sand, or foreign matter will prevent the sealing strip from activating. Failure of the shingles to seal under any of the above circumstances is not a manufacturing defect and CertainTeed will not be responsible for repairing, replacing or hand-sealing any shingles under any such circumstance.

CertainTeed limits its warranty protection to a ten (10) year duration (from date of completion of shingle application to the end of the tenth year of service) for shingles applied to insulated roof deck systems that have not been ventilated between the deck material and the insulation. This warranty obligation is subject to the maximum liability shown in Table 1 and is reduced by the reduction figure shown in Table 1.

CertainTeed reserves the right to discontinue or modify any of its products, including the color of the shingles, and shall not be liable as a result of such discontinuance or modification, nor shall CertainTeed be liable in the event replacement material may vary in color in comparison to the original product as a result of normal weathering. If CertainTeed replaces any material under this warranty, it may substitute products designated by CertainTeed to be of comparable quality or price range in the event the product initially installed has been discontinued or modified.

Limited Wind Warranty

CertainTeed warrants both its fiber glass asphalt shingles and its organic-base asphalt shingles to resist blow-off damage due to wind velocities, including gusts, up to 60 miles per hour (110 miles per hour for Hatteras shingles) during the first ten (10) years following application for Grand Manor Shingle and Hatteras shingles, the first seven (7) years following application for Carriage House Shingle, and for all other shingle products, the first five (5) year period following application of the shingles. If any such blow-off damage does occur during those initial time periods after application, CertainTeed will furnish replacement shingles without charge for those shingles damaged (but will not be responsible for labor costs pertaining to removal or replacement of damaged shingles). However, in the event the shingles involved contain self-sealing asphalt strips, CertainTeed shall have no liability under this Limited Wind Warranty unless it is first afforded the opportunity to hand-seal, at its sole expense, any non-sealing asphalt strips which fail to activate within the first year after application.

Any costs in excess of CertainTeed’s contribution shall be the owner’s responsibility through homeowner’s insurance, etc.

What the Customer Must Do

The property owner must promptly notify CertainTeed in writing of any manufacturing defect or algae contamination and provide proof of the date of purchase and date of application of the shingles. CertainTeed will then investigate the claim, and if a defect covered by this warranty is confirmed, CertainTeed, within a reasonable amount of time after the inspection, will repair, replace or clean the defective shingles or reimburse the property owner the appropriate amount for the repair, replacement or cleaning of the shingles under the terms of the warranty.

Notification should be sent to:

CertainTeed Corporation
1400 Union Meeting Road
Blue Bell, PA 19422
Attn: RPG Consumer Service Dept.

(PLEASE REFER TO NEXT PAGE FOR REMAINDER OF WARRANTY, INCLUDING OTHER CONDITIONS.)

This warranty, which is effective on shingles applied on or after January 1, 1999, supersedes those written warranties previously issued by CertainTeed coded No. 20-20-1335, 20-20-1336 and 20-20-1369.

THIS WARRANTY REPLACES ALL OTHER ORAL OR WRITTEN WARRANTIES, LIABILITIES OR OBLIGATIONS OF CERTAINTEED. PERTINENT STATE LAW SHALL CONTROL FOR WHAT PERIOD OF TIME SUBSEQUENT TO SALE A CONSUMER/HOMEOWNER MAY SEEK A REMEDY PURSUANT TO THE IMPLIED WARRANTY OF MERCHANTABILITY OR FITNESS FOR A PARTICULAR PURPOSE. IN NO EVENT SHALL CERTAINTEED BE LIABLE FOR CONSEQUENTIAL OR INCIDENTAL DAMAGES OF ANY KIND, INCLUDING ANY DAMAGE TO THE BUILDING, ITS CONTENTS OR ANY PERSONS THEREIN, RESULTING FROM THE BREACH OF ANY WARRANTY SET FORTH HEREIN. NO FIELD REPRESENTATIVE OF CERTAINTEED OR ANY DISTRIBUTOR OR DEALER IS AUTHORIZED TO MAKE ANY CHANGE OR MODIFICATION TO THIS WARRANTY. SOME STATES DO NOT ALLOW LIMITATIONS ON OR THE EXCLUSION OF INCIDENTAL OR CONSEQUENTIAL DAMAGES, SO THE ABOVE EXCLUSIONS MAY NOT APPLY TO YOU.

This warranty gives you specific legal rights, and you may also have other rights that vary from state to state. Return of the warranty registration card is not required as a condition of warranty coverage.

ROOFING PLANTS AND REGIONAL SALES OFFICES

CertainTeed roofing products are sold by the Roofing Products Group of CertainTeed Corporation. They are manufactured in four roofing plants and sold in four sales regions, as well as special product areas (SPA).

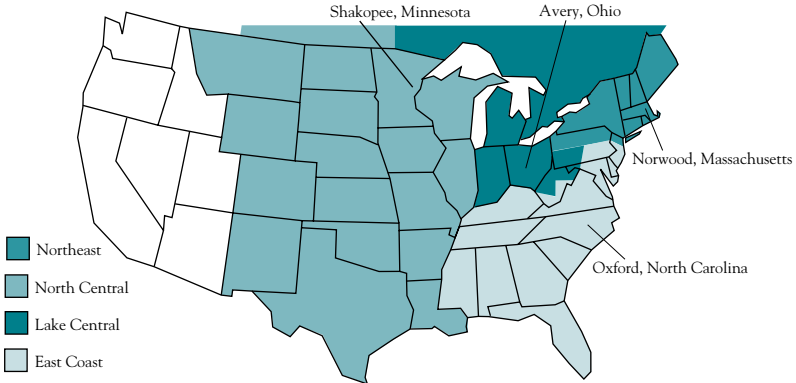

Since the early 1900s, CertainTeed has been an innovator in the building materials industry, today producing and selling vinyl windows, vinyl siding and accessories, vinyl fence, railing and deck products, asphalt roofing shingles, roof ventilation products, clay roof tiles, fiber glass insulation and reinforcements, foundation products, and PVC pipe at more than 100 facilities nationwide. Continuing the 90-year commitment of "quality made certain, satisfaction guaranteed," CertainTeed remains one of the most trusted names in the industry.

CertainTeed Corporation
Roofing Products Group
P.O. Box 860
Valley Forge, PA 19482
800-345-1145

CertainTeed 
Quality made certain. Satisfaction guaranteed.

ASPHALT SHINGLE PRODUCTS
CERTAINTEED CORPORATION



CertainTeed 



LIMITED

WARRANTY

CONGRATULATIONS!

... and thank you for your recent purchase of one of the fine products in the CertainTeed Roofing Collection.™ Since 1904, CertainTeed has been producing quality roofing products that provide long-lasting beauty and protection for homes of every size, style and age. For the past 95 years, the basis for our name, “Quality made *certain*, satisfaction guaranteed,” has been our ongoing philosophy.

Your CertainTeed roofing warranty fully explains how CertainTeed supports its products with the strongest warranty protection available. In the following paragraphs we would like to highlight some of the more important warranty features, and provide some additional information that will help you understand why the quality of your CertainTeed roof is not just a claim, but a fact.

However, it is important that you read the warranty section of this brochure. The warranty lists the specific CertainTeed asphalt shingle products that are covered and the period of time for which they are covered. Take the time to understand how CertainTeed protects your purchase by standing behind our products.

SURESTART™ PROTECTION

Because CertainTeed roofing products are manufactured to the highest quality standards, we confidently include the additional assurance of SureStart™ protection with all CertainTeed shingles. SureStart provides the strongest protection you can get in the vital early years after your new roof has been installed.

Simply put, if a manufacturing defect is discovered during the SureStart period, CertainTeed will provide reimbursement of 100% of the cost of the shingles and labor to repair the defective shingles or apply new shingles to



replace the defective shingles (exclusive of costs of tear-off, metal work and disposal). SureStart protection is not prorated or otherwise reduced over time.

SureStart protection does not extend to any shingles applied to any non-ventilated roof deck systems.

SURESTART™ PLUS PROTECTION

Additional Years of SureStart™ Warranty Protection And an Extension of the Limited Wind Warranty

For an added measure of assurance, SureStart™ PLUS warranty protection extends the duration of both SureStart protection and the limited wind warranty up to a total of ten years. All the same provisions, conditions and limitations that apply to SureStart and the initial limited wind warranty apply to SureStart PLUS coverage.

SureStart PLUS coverage may be obtained through your roofing contractor under the following conditions:

1. The consumer must pay a specified fee to CertainTeed.
2. The roof system must meet the standards of CertainTeed's Integrity Shingle Roof System™.

Limitations

This warranty provides protection against any shingle defects that arise in the course of ordinary and everyday wear and tear to the roof caused by normal exposure to the elements. It does not provide protection against damage caused by situations and events beyond normal exposure conditions, such as, but not limited to:

- winds, including gusts, greater than 60 miles per hour (greater than 110 miles per hour for Hatteras shingles and 80 miles per hour for Grand Manor Shingle and Carriage House Shingle), lightning, hurricane (see Limited Wind Warranty for Hatteras hurricane wind exception), tornado, hailstorm, earthquake, fire, explosion, flood or falling objects.
- distortion, cracking or other failure, or movement of the base material over which the shingles are applied, or of the roof deck, or of the walls or foundation of the building itself.
- damage caused by structural changes, alterations or additions, or by the installation of equipment (such as aerials, signs or air-conditioning equipment) to the structure after the original shingles have been applied.
- stains or contamination to the shingle arising from sources such as, but not limited to, moss, lichens or other vegetation, or paints, chemicals or other similar materials, unless the applied asphalt shingle was sold as an “algae- or fungus-resistant shingle,” in which case CertainTeed will clean, repair or replace, at its option, per the terms of the warranty, only such shingles which are proven to be contaminated with algae during the term of the warranty against algae growth.
- improper storage of CertainTeed shingles.
- installation of shingles over non-approved roof decks as fully explained in the CertainTeed Shingle Applicator’s Manual.
- damage to CertainTeed shingles, the roof deck or the structure caused by ice backup or ice damming.

If the applied shingles contain self-sealing asphalt strips, and if any of these strips fail to activate within the first year following application, CertainTeed shall have no liability under this warranty for such a defect unless CertainTeed is afforded the opportunity to hand-seal, at its sole expense, any non-sealing shingles.

CertainTeed limits its warranty protection to a ten (10) year duration (from date of completion of shingle application to the end of the tenth year of service) for any shingles applied to any non-ventilated roof deck systems. This warranty obligation is subject to the maximum liability shown in Table 1 and is reduced by the reduction figure shown in Table 1.

CertainTeed reserves the right to discontinue or modify any of its products, including the color of the shingles, and shall not be liable as a result of such discontinuance or modification, nor shall CertainTeed be liable in the event replacement material may vary in color in comparison to the original product as a result of normal weathering. If CertainTeed replaces any material under this warranty, it may substitute products designated by CertainTeed to be of comparable quality or price range in the event the product initially installed has been discontinued or modified.

Limited Wind Warranty

CertainTeed warrants both its fiber glass asphalt shingles and its organic-base asphalt shingles to resist blow-off damage due to wind velocities, including gusts, up to 110 miles per hour (including hurricane winds) during the first ten (10) years following application for Hatteras shingles, up to 80 miles per hour during the first ten (10) years following application for Grand Manor Shingle and the first seven (7) years following application for Carriage House Shingle, and up to 60 miles per hour for all other shingle products during the first five (5) year period following application of the shingles. If any such blow-off damage does occur during those initial time periods after application, CertainTeed will furnish replacement shingles without charge for those shingles damaged (but will not be responsible for labor costs pertaining to removal or replacement of damaged shingles). However, in the event the shingles involved contain self-sealing asphalt strips, CertainTeed shall have no liability under this Limited Wind Warranty unless it is first afforded the opportunity to hand-seal, at its sole expense, any non-sealing asphalt strips which fail to activate within the first year after application.

Any costs in excess of CertainTeed’s contribution shall be the owner’s responsibility through homeowner’s insurance, etc.

What the Customer Must Do

The property owner must promptly notify CertainTeed in writing of any manufacturing defect or algae contamination and provide proof of the date of purchase and date of application of the shingles. CertainTeed will then investigate the claim, and if a defect covered by this warranty is confirmed, CertainTeed, within a reasonable amount of time after the inspection, will repair, replace or clean the defective shingles or reimburse the property owner the appropriate amount for the repair, replacement or cleaning of the shingles under the terms of the warranty.

Notification should be sent to:

CertainTeed Corporation
1400 Union Meeting Road
Blue Bell, PA 19422
Attn: RPG Consumer Service Dept.
800-345-1145

(PLEASE REFER TO NEXT PAGE FOR REMAINDER OF WARRANTY, INCLUDING OTHER CONDITIONS.)

WHAT IS AN ALGAE-RESISTANT SHINGLE?

Many of CertainTeed's fiber glass shingles are available in an algae-resistant version. Commonly called "fungus," the black and green algae that creates unsightly streaking on shingles is a common occurrence in warm, humid climates.

In addition to all colors in the Grand Manor Shingle®, Carriage House Shingle™, Hatteras®,

Highlands Shingle™ AR and FungusBuster® 25 product lines, some other products are available in algae-resistant versions in specific regions. CertainTeed shingles carry an exceptional 10-year limited warranty against algae contamination.



WHAT IS A "SHANGLE®"?

The "Shangle®," an idea conceived by CertainTeed over 30 years ago, is the original "laminated shingle." The Shangle features a full-size, one-piece shingle as a base, to which individual shingle tabs or overlay pads are applied, providing extra protection and aesthetic enhancement to the roof.

A *Super* Shangle takes this idea one step further by using it on an 18" x 36" base layer.

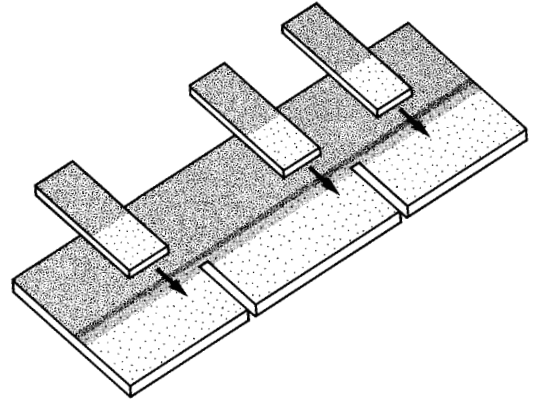

WHAT IS A TWO-PIECE LAMINATE?

Whereas a Shangle consists of a full-size, one-piece base shingle onto which tabs or pads are applied, a two-piece laminate uses a full-size shingle with tab-size teeth cut out of it. Adhered to the back of this top shingle is a half shingle that runs behind the cutouts. The result is a multi-layered shingle that provides a rugged, textured look on the roof.

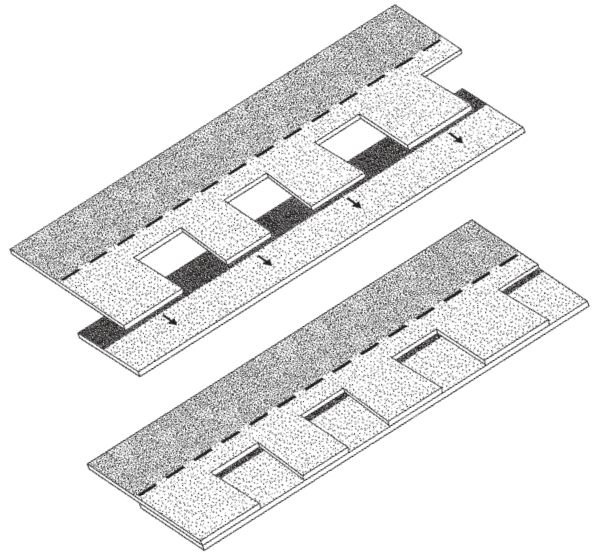

WHAT IS A SELF-SEALING STRIP?

Most shingles contain a factory applied self-sealing asphalt strip which must be subjected to direct sunlight for several days before sealing will occur. Shingles installed in the fall or winter may not seal until the following spring. Shingles which do not receive direct sunlight or which are not exposed to adequate surface temperatures may never seal and must be hand sealed at time of applica-

tion. Shingles which have not been properly installed or damage to the factory applied self-sealing strip by dust, sand, or foreign matter will prevent the sealing strip from activating. Failure of the shingles to seal under any of the above circumstances is not a manufacturing defect and CertainTeed will not be responsible for repairing, replacing or hand-sealing any shingles under any such circumstance.

LIMITED WARRANTY

This warranty covers asphalt shingle products sold only in the United States of America, its territories and Canada.

What and Who Is Covered and for How Long

Provided shingles have been installed in strict accordance with CertainTeed's current written installation instructions, CertainTeed warrants to the original property owner/consumer that its asphalt roofing shingles will be free from manufacturing defects for the length of time specified in the chart below, and that CertainTeed will repair or replace any shingles proven to be defective under the terms of this warranty.

In addition, CertainTeed warrants that Grand Manor Shingle[®], Carriage House Shingle[™], Independence Shingle[®] AR, Hatteras[®], Landmark[™] 40 AR, Landmark[™] 30 AR, High Sierra[®] AR, Estate[®], Architect 80 AR[™], Firehalt[™] 2000 AR, Firehalt[™] AR, Firescreen[™] Plus AR, Firescreen Plus 2000[™], Highlands Shingle[™] AR, FungusBuster[®] 25, Firescreen[™] 2.0 and Firescreen[™] 2.0 AR shingles that were sold as "algae-resistant shingles" will remain free from algae growth which adversely affects the overall appearance of said shingles for a period of ten (10) years. However, CertainTeed reserves the right to clean the algae stains from the shingles rather than repair or replace the contaminated shingles.

In the event of repair, replacement or cleaning pursuant to the terms of this warranty, the original warranty shall apply to the replacement shingles or the repaired or cleaned shingles and will extend for the balance of the warranty period in effect at the time the shingles proved defective.

The lifetime coverage for Grand Manor Shingle and Carriage House Shingle offered by this warranty is designed to cover individual homeowners only. In the instance of shingles purchased by or installed upon property owned by, for example, corporations, governmental agencies, partnerships, trusts, religious organizations, schools, condominiums or cooperative housing arrangements, or installed on apartment buildings or any other type of building or premises not used by individual homeowners as their residence, the warranty period for Grand Manor Shingle and Carriage House Shingle will be 40 years following the installation of the shingles, and in both instances CertainTeed's maximum liability after the SureStart period will be calculated using the figure indicated in Table 1 as the maximum material liability, exclusive of costs of labor, roof tear-off, metal work, and disposal, and by then decreasing that amount by the reduction figure specified in Table 1 for each month as measured from the date the shingles were installed to the date when proven defective.

TABLE 1

PRODUCT	WARRANTY PERIOD	SURESTART [™] PERIOD	MAXIMUM MATERIAL LIABILITY AFTER SURESTART PERIOD	REDUCTION FIGURE PER MONTH
GRAND MANOR SHANGLE [®]	LIFETIME	10 YEARS	\$140/Square	1/480*
CARRIAGE HOUSE SHANGLE [™]	LIFETIME	7 YEARS	\$110/Square	1/480*
INDEPENDENCE SHANGLE [®] (and AR)	40 YEARS	5 YEARS	\$55/Square	1/480
LANDMARK [™] 40 (and AR)	40 YEARS	5 YEARS	\$55/Square	1/480
HATTERAS [®]	40 YEARS	5 YEARS	\$55/Square	1/480
HIGH SIERRA [®]	40 YEARS	5 YEARS	\$55/Square	1/480
WOODSCAPE [®] 40	40 YEARS	5 YEARS	\$55/Square	1/480
ARCHITECT [™] 80 (and AR)	35 YEARS	5 YEARS	\$50/Square	1/420
ESTATE [®] AR	35 YEARS	5 YEARS	\$50/Square	1/420
HALLMARK SHANGLE [®]	30 YEARS	5 YEARS	\$55/Square	1/360
LANDMARK [™] 30 (and AR)	30 YEARS	5 YEARS	\$45/Square	1/360
CUSTOM SEALDON [®] 30	30 YEARS	5 YEARS	\$35/Square	1/360
XT [™] 30	30 YEARS	5 YEARS	\$35/Square	1/360
WOODSCAPE [®] 30	30 YEARS	5 YEARS	\$45/Square	1/360
FIREHALT [™] 2000 (and AR)	30 YEARS	5 YEARS	\$45/Square	1/360
FIRESCREEN PLUS 2000 [™] (and AR)	30 YEARS	5 YEARS	\$35/Square	1/360
LANDMARK [™] 25	25 YEARS	5 YEARS	\$40/Square	1/300
CLASSIC HORIZON SHANGLE [®]	25 YEARS	5 YEARS	\$40/Square	1/300
NEW HORIZON SHANGLE [®]	25 YEARS	5 YEARS	\$40/Square	1/300
HIGHLANDS SHANGLE [™] AR	25 YEARS	5 YEARS	\$40/Square	1/300
HEARTHSTEAD [®] 25	25 YEARS	5 YEARS	\$35/Square	1/300
CUSTOM LOK [™] 25	25 YEARS	5 YEARS	\$35/Square	1/300
FUNGUSBUSTER [®] 25	25 YEARS	5 YEARS	\$30/Square	1/300
XT [™] 25	25 YEARS	5 YEARS	\$30/Square	1/300
SEALDON [®] 25	25 YEARS	5 YEARS	\$30/Square	1/300
WOODSCAPE [®] 25	25 YEARS	5 YEARS	\$40/Square	1/300
FIREHALT [™] (and AR)	25 YEARS	5 YEARS	\$40/Square	1/300
SEAL KING [®] 25	25 YEARS	5 YEARS	\$30/Square	1/300
JET [®] 25	25 YEARS	4 YEARS	\$30/Square	1/300
CT 20	20 YEARS	3 YEARS	\$25/Square	1/240
FIRESCREEN [™] 2.0 (and AR)	20 YEARS	3 YEARS	\$25/Square	1/240
FIRESCREEN [™]	20 YEARS	3 YEARS	\$25/Square	1/240
ANY SHINGLES APPLIED TO ANY NON-VENTILATED ROOF DECK ALGAE-RESISTANCE	10 YEARS	N/A	See above	1/120
	10 YEARS	5 YEARS	See above	1/120

* For Grand Manor Shingle and Carriage House Shingle, at the completion of the 32nd year the reduction figure will remain at 384/480, or 20% of the total maximum liability.

(PLEASE REFER TO NEXT 2 PAGES FOR REMAINDER OF WARRANTY, INCLUDING OTHER CONDITIONS.)

SureStart™ Protection

All of CertainTeed's shingle products are covered by SureStart™ protection for the period specified in Table 1. Under this warranty feature, CertainTeed, at no charge, will repair or replace, at its option, any shingles proven to be defective during the applicable SureStart period (the SureStart period begins when shingle application has been completed and terminates at the end of the year indicated as its term of duration; i.e., the SureStart period for Independence Shingle terminates at the completion of its fifth year of service). CertainTeed's maximum material liability under SureStart will be equal to the reasonable cost to replace the defective shingles, plus labor. CertainTeed shall not be responsible or liable for costs of roof tear-off and disposal and of flashing and metal work (and repairs required by defects therein) except for Grand Manor Shingle and Carriage House Shingle, for which CertainTeed's maximum liability will also include the cost of roof tear-off and disposal.

SureStart protection does not extend to any shingles applied to any non-ventilated roof deck systems upon which the shingles are attached. In the case of these shingles, CertainTeed's maximum contribution toward the cost of repairing, replacing or cleaning the defective shingles will be calculated using the figure indicated in Table 1 as the maximum material liability, exclusive of costs of labor, roof tear-off and disposal, and by then decreasing that amount by the reduction figure specified in Table 1 for each month as measured from the date the shingles were installed to the date when proven defective.

In instances in which CertainTeed, under the terms of this warranty, has agreed to pay the cost of labor required to repair, replace or clean defective or contaminated shingles, CertainTeed will provide reimbursement only upon receipt of a copy of the contractor's invoice or other written evidence of the completion of such work which CertainTeed, in its sole discretion, deems acceptable.

SureStart™ PLUS Protection

Under SureStart™ PLUS warranty protection, which may be purchased under specific conditions and for a specified fee, CertainTeed will repair or replace, at its option, any shingles proven to be defective during the additional five-year period (three years for Carriage House Shingle) subsequent to the SureStart protection period applicable to the particular shingle product. In no event shall the total duration of the initial SureStart protection and SureStart PLUS protection exceed ten (10) years. SureStart PLUS warranty protection is not applicable to Grand Manor Shingle (already carries the maximum 10-year SureStart Protection). Under SureStart PLUS coverage, CertainTeed also warrants its shingles to resist blow-off damage due to wind velocities, including gusts, up to 60 miles per hour (80 miles per hour for Grand Manor Shingle and Carriage House Shingle and 110 miles per hour for Hatteras) for an additional five-year period (three years for Carriage House Shingle) subsequent to the five-year limited wind warranty which is applicable to all CertainTeed shingle products. This additional wind warranty protection is not applicable to Grand Manor Shingle and Hatteras (both already carry the maximum 10-year wind warranty duration).

All provisions of the SureStart feature and of the initial limited wind warranty, as set forth herein, shall apply to SureStart PLUS coverage.

Beyond SureStart™ or SureStart™ PLUS Protection

Should any shingles prove to be defective subsequent to the SureStart™ or SureStart™ PLUS period, CertainTeed's maximum contribution toward the cost of repairing or replacing the defective shingles will be calculated using the figure indicated in Table 1 as the maximum material liability, exclusive of costs of labor, roof tear-off and disposal, and by then decreasing that amount by the specified reduction figure for each month as measured from the date the shingles were installed to the date when proven defective.

Transferability

DURING THE SURESTART OR SURESTART PLUS PERIOD

This limited warranty may be transferred by the original consumer to the subsequent property owner.

With respect to Grand Manor Shingle, if this warranty is effectively transferred during the ten (10) year SureStart period, the duration of the warranty will be 40 years measured from the date of installation, and the remaining period of SureStart protection will be available to the subsequent property owner.

With respect to Carriage House Shingle, if this warranty is effectively transferred during the SureStart or SureStart PLUS periods, the duration of the warranty will be 40 years measured from the date of installation, and the remaining period of SureStart or SureStart PLUS protection will be available to the subsequent property owner.

The lifetime coverage offered by this warranty for Grand Manor Shingle and Carriage House Shingle automatically ceases not only upon sale of the property, but also upon the death of the last of the original owners of the property at the time of installation. In either event, the warranty will cover 40 years and CertainTeed's maximum contribution toward the cost of repairing or replacing the defective shingles will be calculated as explained in the above section titled "Beyond SureStart or SureStart PLUS Protection."

For all other shingle products, if the warranty is transferred by the original consumer during the SureStart or SureStart PLUS periods, the duration of the warranty, measured from the date of installation, will remain the same as for the original consumer, and the remaining period of SureStart or SureStart PLUS protection will be available to the subsequent property owner.

AFTER THE SURESTART OR SURESTART PLUS PERIOD

In the event that the warranty is transferred by the original consumer subsequent to the SureStart or SureStart PLUS period, the warranty duration following the transfer will be two years from the date of real estate title transfer, and the warranty obligation will be calculated as explained in the above section titled "Beyond SureStart or SureStart PLUS Protection."

3. The roof system must have been installed by a contractor who, at the time of the roof installation, holds credentials as a CertainTeed SELECT Shingle RooferSM.

The CertainTeed Integrity Shingle Roof System must incorporate all of the following components:

1. CertainTeed shingles carrying a warranty duration of at least 25 years and installed according to the instructions in the CertainTeed Shingle Applicator's Manual. Shingles must meet UL certification in order to prove they are ASTM 3462 compliant.
2. Unless a specific exception has been granted in advance by CertainTeed, Air Vent Inc. attic ventilation products or CertainTeed soffit and eaves ventilation products installed: (a) to meet applicable model code requirements or HUD/FHA minimum property standards for attic ventilation; (b) according to manufacturer's installation instructions applicable to the roof system at the time of installation; (c) in accordance with CertainTeed's shingle warranty requirements for attic ventilation.

3. Underlayment installed in accordance with installation instructions published in the CertainTeed Shingle Applicator's Manual. Underlayment must be manufactured by CertainTeed where geographically available, or it must meet standards of performance set forth by ASTM Standard D4869 or D229 (unperforated).
4. In areas in or north of the following states – Virginia, Kentucky, Missouri, Kansas, Colorado, Utah, Nevada, Oregon or in a snow zone* – CertainTeed's WinterGuardTM Series waterproofing shingle underlayments installed at the roof eaves and in the valleys according to instructions in the CertainTeed Shingle Applicator's Manual.

A CertainTeed SELECT Shingle Roofer is a contractor who has qualified for inclusion in this exclusive program by virtue of having completed specific professional and educational programs, and by carrying the requisite amount of both liability insurance and workers' compensation insurance. Your SELECT Shingle Roofer can provide complete details about the Integrity Shingle Roof System and how to apply for SureStart PLUS warranty protection.

* as defined by National Oceanic and Atmospheric Administration

TRANSFERABILITY

The warranty for CertainTeed shingles is transferable by the original property owner to the subsequent owner. Upon transfer of the warranty during the product's SureStart or SureStart PLUS periods, the remaining duration of the warranty for the new owner is the same as it would have been for the original owner.

And, the remaining period of SureStart or SureStart PLUS protection will be available to the subsequent property owner.

For product warranties transferred after the SureStart or SureStart PLUS period has elapsed, the remaining duration of the transferred warranty will be **two** years from the date of real estate title transfer.

This warranty, which is effective on shingles applied on or after January 1, 2000, supersedes those written warranties previously issued by CertainTeed coded No. 20-20-1383 and 20-20-1429.

THIS WARRANTY REPLACES ALL OTHER ORAL OR WRITTEN WARRANTIES, LIABILITIES OR OBLIGATIONS OF CERTAINTEED. PERTINENT STATE LAW SHALL CONTROL FOR WHAT PERIOD OF TIME SUBSEQUENT TO SALE A CONSUMER/HOMEOWNER MAY SEEK A REMEDY PURSUANT TO THE IMPLIED WARRANTY OF MERCHANTABILITY OR FITNESS FOR A PARTICULAR PURPOSE. IN NO EVENT SHALL CERTAINTEED BE LIABLE FOR CONSEQUENTIAL OR INCIDENTAL DAMAGES OF ANY KIND, INCLUDING ANY DAMAGE TO THE BUILDING, ITS CONTENTS OR ANY PERSONS THEREIN, RESULTING FROM THE BREACH OF ANY WARRANTY SET FORTH HEREIN. NO FIELD REPRESENTATIVE, DISTRIBUTOR OR DEALER OF CERTAINTEED IS AUTHORIZED TO MAKE ANY CHANGE OR MODIFICATION TO THIS WARRANTY. SOME STATES DO NOT ALLOW LIMITATIONS ON OR THE EXCLUSION OF INCIDENTAL OR CONSEQUENTIAL DAMAGES, SO THE ABOVE EXCLUSIONS MAY NOT APPLY TO YOU.

This warranty gives you specific legal rights, and you may also have other rights that vary from state to state.

Return of the warranty registration card is not required as a condition of warranty coverage.

ROOFING PLANTS AND REGIONAL SALES OFFICES

CertainTeed roofing products are sold by the Roofing Products Group of CertainTeed Corporation in eight sales regions. They are manufactured in eleven residential roofing plants and two commercial roofing plants.

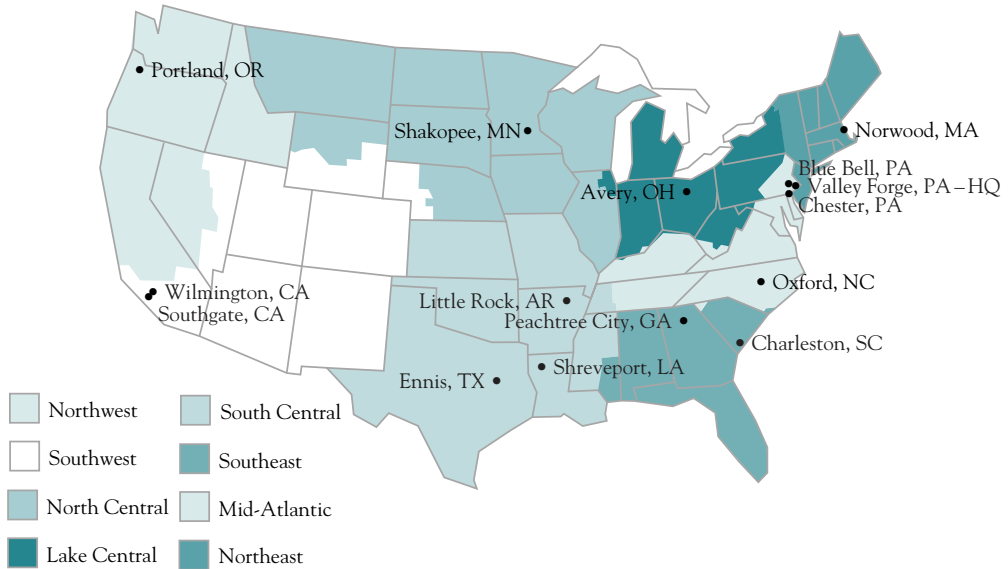

Since the early 1900's, CertainTeed has been an innovator in the building materials industry, today producing and selling vinyl windows, siding, fencing, railing and deck products, asphalt roofing shingles and commercial roofing products, attic ventilation products, fiber glass insulation and reinforcements, and piping and foundation products, at more than 100 facilities nationwide. Continuing the 95-year commitment of "quality made *certain*, satisfaction *guaranteed*," CertainTeed remains one of the most trusted names in the industry.

CertainTeed Corporation
Roofing Products Group
P.O. Box 860
Valley Forge, PA 19482
800-345-1145

CertainTeed 
Quality made certain. Satisfaction guaranteed.

WARRANTY LIMITED



Asphalt Shingle Products

CertainTeed Corporation

P.O. Box 860, Valley Forge, PA 19482

This warranty covers asphalt shingle products
sold only in the United States of America, its territories and Canada.

What and Who Is Covered and for How Long

Provided shingles have been installed in strict accordance with CertainTeed's current written installation instructions, CertainTeed warrants to the original property owner/consumer that its asphalt roofing shingles will be free from manufacturing defects for the length of time specified in Table 1, and that CertainTeed will repair or replace any shingles proven to be defective under the terms of this warranty.

In addition, CertainTeed warrants that Grand Manor Shingle[®], Carriage House Shingle[™], Celotex Presidential TL[™], Celotex Ambassador Shake[™] AR, and Celotex Presidential Shake[™] AR that were sold as "algae-resistant shingles" will remain free from algae growth which adversely affects the overall appearance of said shingles for a period of fifteen (15) years, and that Independence Shingle[®] AR, Hatteras[®], Landmark[™] 40 AR, Landmark[™] 30 AR, Landmark[™] 25 AR, High Sierra[®], Architect[™] 80 AR, Firehalt[™] 2000 AR, Firehalt[™] AR, Celotex Dimensional[®] 40 AR, Celotex Dimensional[®] 30 AR, Celotex Dimensional[®] 25 AR, XT[™] 30 AR, XT[™] 25 AR, Highlands Shingle[™] AR, and CT 20 AR shingles that were sold as "algae-resistant shingles" will remain free from algae growth which adversely affects the overall appearance of said shingles for a period of ten (10) years. However, CertainTeed reserves the right to clean the algae stains from the shingles rather than repair or replace the contaminated shingles.

In the event of repair, replacement or cleaning pursuant to the terms of this warranty, the original warranty shall apply to the replacement shingles or the repaired or cleaned shingles and will extend for the balance of the warranty period in effect at the time the shingles proved defective.

The lifetime coverage for Grand Manor Shingle, Carriage House Shingle, Celotex Presidential TL, and Celotex Ambassador Shake offered by this warranty is designed to cover individual homeowners only. In the instance of shingles purchased by or installed upon property owned by, for example, corporations, governmental agencies, partnerships, trusts, religious organizations, schools, condominiums or cooperative housing arrangements, or installed on apartment buildings or any other type of building or premises not used by individual homeowners as their residence, the warranty period for Grand Manor Shingle, Carriage House Shingle, Celotex Presidential TL and Celotex Ambassador Shake will be 40 years following the installation of the shingles, and in all four instances CertainTeed's maximum liability after the SureStart period will be calculated using the figure indicated in Table 1 as the maximum material liability, exclusive of costs of labor, roof tear-off, metal work, and disposal, and by then decreasing that amount by the reduction figure specified in Table 1 for each month as measured from the date the shingles were installed to the date when proven defective.

SureStart[™] Protection

All of CertainTeed's shingle products are covered by SureStart[™] protection for the period specified in Table 1. Under this warranty feature, CertainTeed, at no charge, will repair or replace, at its option, any shingles proven to be defective during the applicable SureStart period (the SureStart period begins when shingle application has been completed and terminates at the end of the year indicated as its term of duration; i.e., the SureStart period for Independence Shingle terminates at the

TABLE 1

Product	Warranty Period	SureStart [™] Period	Wind Warranty MPH	Algae Resistant Warranty Period**	Maximum Material Liability After SureStart Period	Reduction Figure Per Month
GRAND MANOR SHANGLE [®]	LIFETIME	10 YEARS	85	15	\$140/Square	1/480*
CARRIAGE HOUSE SHANGLE [™]	LIFETIME	10 YEARS	85	15	\$110/Square	1/480*
CELOTEX PRESIDENTIAL TL [™]	LIFETIME	10 YEARS	85	15	\$140 Square	1/480*
CELOTEX AMBASSADOR SHAKE [™]	LIFETIME	10 YEARS	85	15	\$120/Square	1/480*
CELOTEX PRESIDENTIAL SHAKE [™] (and AR)	40 YEARS	10 YEARS	85	15	\$95/Square	1/480
INDEPENDENCE SHANGLE [®] (and AR)	40 YEARS	5 YEARS	80	10	\$55/Square	1/480
LANDMARK [™] 40 (and AR)	40 YEARS	5 YEARS	80	10	\$55/Square	1/480
HATTERAS [®]	40 YEARS	5 YEARS	110	10	\$55/Square	1/480
HIGH SIERRA [®]	40 YEARS	5 YEARS	80	N/A	\$55/Square	1/480
WOODSCAPE [®] 40	40 YEARS	5 YEARS	80	N/A	\$55/Square	1/480
CELOTEX DIMENSIONAL [®] 40 (and AR)	40 YEARS	5 YEARS	80	10	\$55/Square	1/480
ARCHITECT [™] 80 (and AR)	35 YEARS	5 YEARS	70	10	\$50/Square	1/420
HALLMARK SHANGLE [®]	30 YEARS	5 YEARS	60	N/A	\$55/Square	1/360
LANDMARK [™] 30 (and AR)	30 YEARS	5 YEARS	70	10	\$45/Square	1/360
CUSTOM SEALDON [®] 30	30 YEARS	5 YEARS	80	N/A	\$35/Square	1/360
XT [™] 30 (and AR)	30 YEARS	5 YEARS	80	10	\$35/Square	1/360
WOODSCAPE [®] 30	30 YEARS	5 YEARS	70	N/A	\$45/Square	1/360
FIREHALT [™] 2000 (and AR)	30 YEARS	5 YEARS	70	10	\$45/Square	1/360
CELOTEX DIMENSIONAL [®] 30 (and AR)	30 YEARS	5 YEARS	70	10	\$45/Square	1/360
FIRESCREEN PLUS 2000 [™]	30 YEARS	5 YEARS	80	N/A	\$35/Square	1/360
LANDMARK [™] 25 (and AR)	25 YEARS	5 YEARS	60	10	\$40/Square	1/300
CLASSIC HORIZON SHANGLE [®]	25 YEARS	5 YEARS	60	N/A	\$40/Square	1/300
NEW HORIZON SHANGLE [®]	25 YEARS	5 YEARS	60	N/A	\$40/Square	1/300
HIGHLANDS SHANGLE [™] AR	25 YEARS	5 YEARS	60	10	\$40/Square	1/300
HEARTHSTEAD [®]	25 YEARS	5 YEARS	60	N/A	\$35/Square	1/300
CUSTOM LOK [™] 25	25 YEARS	5 YEARS	60	N/A	\$35/Square	1/300
XT [™] 25 (and AR)	25 YEARS	5 YEARS	60	10	\$30/Square	1/300
SEALDON [®] 25	25 YEARS	5 YEARS	60	N/A	\$30/Square	1/300
WOODSCAPE [®] 25	25 YEARS	5 YEARS	60	N/A	\$40/Square	1/300
FIREHALT [™] (and AR)	25 YEARS	5 YEARS	60	10	\$40/Square	1/300
CELOTEX DIMENSIONAL [®] 25 (and AR)	25 YEARS	5 YEARS	60	10	\$40/Square	1/300
SEAL KING [®] 25	25 YEARS	5 YEARS	60	N/A	\$30/Square	1/300
JET [™] 25	25 YEARS	4 YEARS	60	N/A	\$30/Square	1/300
CT 20 (and AR)	20 YEARS	3 YEARS	60	10	\$25/Square	1/240
FIRESCREEN [™]	20 YEARS	3 YEARS	60	N/A	\$25/Square	1/240
ANY SHINGLES APPLIED TO ANY INADEQUATELY VENTILATED ROOF DECK	10 YEARS†	N/A	N/A	N/A	See Above	1/120

* For Grand Manor Shingle, Carriage House Shingle, Celotex Presidential TL and Celotex Ambassador Shake, at the completion of the 32nd year the reduction figure will remain at 384/480, or 20% of the total maximum liability.

** Period cited is only applicable to AR version of the pertinent shingle.

† For details of warranty coverage for shingles installed on inadequately ventilated roof decks on both residential and commercial buildings, see provisions on page 7 under "Limitations."

completion of its fifth year of service). CertainTeed's maximum material liability under SureStart will be equal to the reasonable cost to replace the defective shingles, plus labor. CertainTeed shall not be responsible or liable for costs of roof tear-off and disposal and of flashing and metal work (and repairs required



CertainTeed

by defects therein) except for Grand Manor Shingle, Carriage House Shingle, Celotex Presidential TL and Celotex Ambassador Shake, for which CertainTeed's maximum liability will also include the cost of roof tear-off and disposal.

SureStart protection does not extend to any shingles applied to any inadequately ventilated roof deck systems upon which the shingles are attached. In the case of these shingles, CertainTeed's maximum contribution toward the cost of repairing, replacing or cleaning the defective shingles will be calculated using the figure indicated in Table 1 as the maximum material liability, exclusive of costs of labor, roof tear-off and disposal, and by then decreasing that amount by the reduction figure (related to shingles applied to an inadequately ventilated roof deck) for each month as measured from the date the shingles were installed to the date when proven defective.

In instances in which CertainTeed, under the terms of this warranty, has agreed to pay the cost of labor required to repair, replace or clean defective or contaminated shingles, CertainTeed will provide reimbursement only upon receipt of a copy of the contractor's invoice or other written evidence of the completion of such work which CertainTeed, in its sole discretion, deems acceptable.

Beyond SureStart™ Protection

Should any shingles prove to be defective subsequent to the SureStart™ period, CertainTeed's maximum contribution toward the cost of repairing or replacing the defective shingles will be calculated using the figure indicated in Table 1 as the maximum material liability, exclusive of costs of labor, roof tear-off and disposal, and by then decreasing that amount by the specified reduction figure for each month as measured from the date the shingles were installed to the date when proven defective.

Transferability

DURING THE SURESTART PERIOD

This limited warranty may be transferred by the original consumer to the subsequent property owner.

With respect to Grand Manor Shingle, Carriage House Shingle, Celotex Presidential TL and Celotex Ambassador Shake, if this warranty is effectively transferred during the ten (10) year SureStart period, the duration of the warranty will be 40 years measured from the date of installation, and the remaining period of SureStart protection will be available to the subsequent property owner.

The lifetime coverage offered by this warranty for Grand Manor Shingle, Carriage House Shingle, Celotex Presidential TL and Celotex Ambassador Shake automatically ceases not only upon sale of the property, but also upon the death of the last of the original owners of the property at the time of installation. In either event, the warranty will cover 40 years and CertainTeed's maximum contribution toward the cost of repairing or replacing the defective shingles will be calculated as explained in the above section titled "Beyond SureStart Protection."

For all other shingle products, if the warranty is transferred by the original consumer during the SureStart period, the duration of the warranty, measured from the date of installation, will remain the same as for the original consumer, and the remaining period of SureStart protection will be available to the subsequent property owner.

AFTER THE SURESTART PERIOD

In the event that the warranty is transferred by the original consumer subsequent to the SureStart period, the warranty duration following the transfer will be two years from the date of real estate title transfer, and the warranty obligation will be calculated as explained in the above section titled "Beyond SureStart Protection."

Limitations

This warranty provides protection against any shingle defects that arise in the course of ordinary and everyday wear and tear to the roof caused by normal exposure to the elements. It does not provide protection against damage caused by situations and events beyond normal exposure conditions, such as, but not limited to:

- winds, including gusts, greater than those listed in Table 1 for each product, lightning, hurricane (see Limited Wind Warranty for Hatteras hurricane wind exception), tornado, hailstorm, earthquake, fire, explosion, flood or falling objects.

- distortion, cracking or other failure, or movement of the base material over which the shingles are applied, or of the roof deck, or of the walls or foundation of the building itself.
- damage caused by structural changes, alterations or additions, or by the installation of equipment (such as aerials, signs or air-conditioning equipment) to the structure after the original shingles have been applied.
- stains or contamination to the shingle arising from sources such as, but not limited to, moss, lichens or other vegetation, or paints, chemicals or other similar materials, unless the applied asphalt shingle was sold as an "algae-resistant shingle," in which case CertainTeed will clean, repair or replace, at its option, per the terms of the warranty, only such shingles which are proven to be contaminated with algae during the term of the warranty against algae growth.
- improper storage of CertainTeed shingles.
- installation of shingles over non-approved roof decks as fully explained in the CertainTeed Shingle Applicator's Manual.
- damage to CertainTeed shingles, the roof deck or the structure caused by ice backup or ice damming.

If the applied shingles contain self-sealing asphalt strips, and if any of these strips fail to activate within the first year following application, CertainTeed shall have no liability under this warranty for such a defect unless CertainTeed is afforded the opportunity to hand-seal, at its sole expense, any non-sealing shingles.

CertainTeed reserves the right to discontinue or modify any of its products, including the color of the shingles, and shall not be liable as a result of such discontinuance or modification, nor shall CertainTeed be liable in the event replacement material may vary in color in comparison to the original product as a result of normal weathering. If CertainTeed replaces any material under this warranty, it may substitute products designated by CertainTeed to be of comparable quality or price range in the event the product initially installed has been discontinued or modified.

Inadequately Ventilated Roof Decks

This limited warranty (with no reduction in warranty duration) will apply under the following conditions to CertainTeed's "top-of-the-line" roofing shingles installed on commercial buildings without adequate ventilation installed directly beneath the shingled roof deck (and directly above the insulation):

1. Shingles must be among those covered in this limited warranty by a 40-year or longer warranty duration. Shingles with a lesser warranted life will qualify for only a 10-year warranty duration with respect to shingle problems related to the absence of adequate roof ventilation.
2. Only "Structural Insulated Panels" (SIPs) or "nailboard insulation panels" having either minimum 3/8" plywood or minimum 7/16" OSB on their top surface may be used as the substrate upon which the shingles are applied. Use of any other inadequately ventilated insulated substrate will limit the warranty duration to only 10 years with respect to shingle problems related to the absence of adequate roof ventilation.
3. Shingles must be applied to a non-residential building.
4. Appropriate insulation and vapor retarder, if necessary, must be installed in order to prevent deterioration of the roof deck or shingle substrate affecting either shingle appearance or shingle performance due to excessive moisture. It is the responsibility of the deck system manufacturer and/or deck system designer to choose the appropriate insulation and to determine the need for a vapor retarder.

Shingles installed on a private home or residence (as opposed to an apartment building, for example) will qualify for a warranty duration of only 10 years with respect to shingle problems related to the absence of adequate roof ventilation. This 10-year warranty duration applies even if CertainTeed's "top-of-the-line" shingles have been used.

In any instance in which the shingles qualify for only a 10-year warranty, CertainTeed's obligation will be calculated by using both the maximum material liability and pertinent monthly reduction figure shown in Table 1 related to shingles applied to an inadequately ventilated roof deck.

Limited Wind Warranty

CertainTeed warrants both its fiber glass asphalt shingles and its organic-base asphalt shingles to resist blow-off damage due to wind velocities, including gusts, up to 110 miles per hour (including hurricane winds) during the first ten (10) years following application for Hatteras shingles and up to 85 miles per hour during the first ten (10) years following application for Grand Manor Shingle, Carriage House Shingle, Celotex Presidential TL™ and Celotex Ambassador Shake. All other shingle products are warranted to resist blow-off damage due to wind velocities, including gusts, up to the maximum wind velocity per product listed in Table 1 during the first five (5) year period following application of the shingles. If any such blow-off damage does occur during those initial time periods after application, CertainTeed will furnish replacement shingles without charge for those shingles damaged (but will not be responsible for labor costs pertaining to removal or replacement of damaged shingles). However, in the event the shingles involved contain self-sealing asphalt strips, CertainTeed shall have no liability under this Limited Wind Warranty unless it is first afforded the opportunity to hand-seal, at its sole expense, any non-sealing asphalt strips which fail to activate within the first year after application.

Any costs in excess of CertainTeed's contribution shall be the owner's responsibility through homeowner's insurance, etc.

What the Customer Must Do

The property owner must promptly notify CertainTeed in writing of any manufacturing defect or algae contamination and provide proof of the date of purchase and date of application of the shingles. CertainTeed will then investigate the claim, and if a defect covered by this warranty is confirmed, CertainTeed, within a reasonable amount of time after the inspection, will repair, replace or clean the defective shingles or reimburse the property owner the appropriate amount for the repair, replacement or cleaning of the shingles under the terms of the warranty.

Notification should be sent to:

CertainTeed Corporation
1400 Union Meeting Road
Blue Bell, PA 19422
Attn: RPG Consumer Service Dept.
800-345-1145

This warranty, which is effective on shingles applied on or after January 1, 2001, supersedes the written warranty previously issued by CertainTeed coded No. 20-20-1569.

THIS WARRANTY REPLACES ALL OTHER ORAL OR WRITTEN WARRANTIES, LIABILITIES OR OBLIGATIONS OF CERTAINTEED. PERTINENT STATE LAW SHALL CONTROL FOR WHAT PERIOD OF TIME SUBSEQUENT TO SALE A CONSUMER/HOMEOWNER MAY SEEK A REMEDY PURSUANT TO THE IMPLIED WARRANTY OF MERCHANTABILITY OR FITNESS FOR A PARTICULAR PURPOSE. IN NO EVENT SHALL CERTAINTEED BE LIABLE FOR CONSEQUENTIAL OR INCIDENTAL DAMAGES OF ANY KIND, INCLUDING ANY DAMAGE TO THE BUILDING, ITS CONTENTS OR ANY PERSONS THEREIN, RESULTING FROM THE BREACH OF ANY WARRANTY SET FORTH HEREIN. NO FIELD REPRESENTATIVE, DISTRIBUTOR OR DEALER OF CERTAINTEED IS AUTHORIZED TO MAKE ANY CHANGE OR MODIFICATION TO THIS WARRANTY. SOME STATES DO NOT ALLOW LIMITATIONS ON OR THE EXCLUSION OF INCIDENTAL OR CONSEQUENTIAL DAMAGES, SO THE ABOVE EXCLUSIONS MAY NOT APPLY TO YOU.

This warranty gives you specific legal rights, and you may also have other rights that vary from state to state.

CertainTeed Corporation
Roofing Products Group
P.O. Box 860
Valley Forge, PA 19482
800-345-1145

WARRANTY

Asphalt Shingle Products

CertainTeed Corporation

P.O. Box 860, Valley Forge, PA 19482

*This warranty covers asphalt shingle products
sold only in the United States of America, its territories and Canada.*

What and Who Is Covered and for How Long

Provided shingles have been installed in strict accordance with CertainTeed's current written installation instructions, CertainTeed warrants to the original property owner/consumer that its asphalt roofing shingles will be free from manufacturing defects for the length of time specified in Table 1, and that CertainTeed will repair or replace any shingles proven to be defective under the terms of this warranty.

In addition, CertainTeed warrants that the Algae-Resistant versions of Grand Manor Shingle[®], Carriage House Shingle[™], Presidential Shake TL[™], Landmark TL[™] and Presidential Shake[™] AR will remain free from algae growth which adversely affects the overall appearance of said shingles for a period of fifteen (15) years, and that Independence Shingle[®] AR, Hatteras[®], Landmark[™] 50 AR, Landmark[™] 40 AR, Landmark[™] 30 AR, Firehail[™] AR, XT[™] 30 AR, XT[™] 25 AR and CT 20 AR shingles that were sold as "algae-resistant shingles" will remain free from algae growth which adversely affects the overall appearance of said shingles for a period of ten (10) years. However, CertainTeed reserves the right to clean the algae stains from the shingles rather than repair or replace the contaminated shingles.

In the event of repair, replacement or cleaning pursuant to the terms of this warranty, the original warranty shall apply to the replacement shingles or the repaired or cleaned shingles and will extend for the balance of the warranty period in effect at the time the shingles proved defective.

The lifetime coverage for Grand Manor Shingle, Carriage House Shingle, Presidential Shake TL, and Landmark TL offered by this warranty is designed to cover individual homeowners only. In the instance of shingles purchased by or installed upon property owned by, for example, corporations, governmental agencies, partnerships, trusts, religious organizations, schools, condominiums or cooperative housing arrangements, or installed on apartment buildings or any other type of building or premises not used by individual homeowners as their residence, the warranty period for Grand Manor Shingle, Carriage House Shingle, Presidential Shake TL and Landmark TL will be 50 years following the installation of the shingles, and in all four instances CertainTeed's maximum liability after the SureStart period will be calculated using the figure indicated in Table 1 as the maximum material liability, exclusive of costs of labor, roof tear-off, metal work, and disposal, and by then decreasing that amount by the reduction figure specified in Table 1 for each month as measured from the date the shingles were installed to the date when proven defective.

SureStart[™] Protection

All of CertainTeed's shingle products are covered by SureStart[™] protection for the period specified in Table 1. Under this warranty feature, CertainTeed, at no charge, will repair or replace, at its option, any shingles proven to be defective during the applicable SureStart period (the SureStart period begins when shingle application has been completed and terminates at the end of the year indicated as its term of duration; i.e., the SureStart period for Independence Shingle terminates at the

TABLE 1

Product	Warranty Period	SureStart [™] Period	Wind Warranty MPH	Algae Resistant Warranty Period**	Maximum Material Liability After SureStart Period	Reduction Figure Per Month
GRAND MANOR SHANGLE [®]	LIFETIME	10 YEARS	110	15	\$140/Square	1/600*
CARRIAGE HOUSE SHANGLE [™]	LIFETIME	10 YEARS	110	15	\$110/Square	1/600*
PRESIDENTIAL SHAKE TL [™]	LIFETIME	10 YEARS	110	15	\$140 Square	1/600*
LANDMARK TL [™]	LIFETIME	10 YEARS	110	15	\$120/Square	1/600*
PRESIDENTIAL SHAKE [™] (and AR)	50 YEARS	10 YEARS	90	15	\$95/Square	1/600
LANDMARK [™] 50 (and AR)	50 YEARS	5 YEARS	90	10	\$55/Square	1/600
WOODSCAPE [®] 50	50 YEARS	5 YEARS	90	N/A	\$55/Square	1/600
INDEPENDENCE SHANGLE [®] (and AR)	50 YEARS	5 YEARS	90	10	\$55/Square	1/600
HATTERAS [®]	40 YEARS	5 YEARS	110	10	\$55/Square	1/480
LANDMARK [™] 40 (and AR)	40 YEARS	5 YEARS	80	10	\$45/Square	1/480
WOODSCAPE [®] 40	40 YEARS	5 YEARS	80	N/A	\$45/Square	1/480
HALLMARK SHANGLE [®]	30 YEARS	5 YEARS	60	N/A	\$55/Square	1/360
CUSTOM SEALDON [®] 30	30 YEARS	5 YEARS	80	N/A	\$35/Square	1/360
XT [™] 30 (and AR)	30 YEARS	5 YEARS	80	10	\$35/Square	1/360
LANDMARK [™] 30 (and AR)	30 YEARS	5 YEARS	70††	10	\$40/Square	1/360
WOODSCAPE [®] 30	30 YEARS	5 YEARS	70††	N/A	\$40/Square	1/360
CLASSIC HORIZON SHANGLE [®]	25 YEARS	5 YEARS	60	N/A	\$40/Square	1/300
NEW HORIZON SHANGLE [®]	25 YEARS	5 YEARS	60	N/A	\$40/Square	1/300
HEARTHSTEAD [®]	25 YEARS	5 YEARS	60	N/A	\$35/Square	1/300
CUSTOM 1.0K [™] 25	25 YEARS	5 YEARS	60	N/A	\$35/Square	1/300
XT [™] 25 (and AR)	25 YEARS	5 YEARS	60	10	\$30/Square	1/300
SEALDON [®] 25	25 YEARS	5 YEARS	60	N/A	\$30/Square	1/300
FIREHAIL [™] (and AR)	25 YEARS	5 YEARS	60	10	\$40/Square	1/300
SEAL KING [®] 25	25 YEARS	5 YEARS	60	N/A	\$30/Square	1/300
JET [™] 25	25 YEARS	4 YEARS	60	N/A	\$30/Square	1/300
CT 20 (and AR)	20 YEARS	3 YEARS	60	10	\$25/Square	1/240
FIRESCREEN [™]	20 YEARS	3 YEARS	60	N/A	\$25/Square	1/240
ANY SHINGLES APPLIED TO ANY INADEQUATELY VENTILATED ROOF DECK	10 YEARS†	N/A	N/A	N/A	See Above	1/120

* For Grand Manor Shingle, Carriage House Shingle, Presidential Shake TL and Landmark TL, at the completion of the 40th year the reduction figure will remain at 480/600, or 20% of the total maximum liability.

** Algae-Resistant Warranty period cited is only applicable to Algae Resistant version of the pertinent shingle.

† For details of warranty coverage for shingles installed on inadequately ventilated roof decks on both residential and commercial buildings, see provisions on page 7 under "Limitations."

†† Landmark 30 and Woodscape 30 roof shingles shall be resistant to blow-off due to wind velocities, including gusts, up to a maximum of 80 miles per hour, during the first five (5) years following application, provided that the shingles are installed using six (6) fasteners per shingle.

completion of its fifth year of service). CertainTeed's maximum material liability under SureStart will be equal to the reasonable cost to replace the defective shingles, plus labor. CertainTeed shall not be responsible or liable for costs of roof tear-off and disposal and of flashing and metal work (and repairs required by defects therein) except for Grand Manor Shingle, Carriage House Shingle, Presidential Shake TL and Landmark TL, for which CertainTeed's maximum liability will also include the cost of roof tear-off and disposal.

SureStart protection does not extend to any shingles applied to any inadequately ventilated roof deck systems upon which

the shingles are attached. In the case of these shingles, CertainTeed's maximum contribution toward the cost of repairing, replacing or cleaning the defective shingles will be calculated using the figure indicated in Table 1 as the maximum material liability, exclusive of costs of labor, roof tear-off and disposal, and by then decreasing that amount by the reduction figure (related to shingles applied to an inadequately ventilated roof deck) for



CertainTeed

each month as measured from the date the shingles were installed to the date when proven defective.

In instances in which CertainTeed, under the terms of this warranty, has agreed to pay the cost of labor required to repair, replace or clean defective or contaminated shingles, CertainTeed will provide reimbursement only upon receipt of a copy of the contractor's invoice or other written evidence of the completion of such work which CertainTeed, in its sole discretion, deems acceptable.

Beyond SureStart™ Protection

Should any shingles prove to be defective subsequent to the SureStart™ period, CertainTeed's maximum contribution toward the cost of repairing or replacing the defective shingles will be calculated using the figure indicated in Table 1 as the maximum material liability, exclusive of costs of labor, roof tear-off and disposal, and by then decreasing that amount by the specified reduction figure for each month as measured from the date the shingles were installed to the date when proven defective.

Transferability

DURING THE SURESTART PERIOD

This limited warranty may be transferred by the original consumer to the subsequent property owner.

With respect to Grand Manor Shingle, Carriage House Shingle, Presidential Shake TL and Landmark TL, if this warranty is effectively transferred during the ten (10) year SureStart period, the duration of the warranty will be 40 years measured from the date of installation, and the remaining period of SureStart protection will be available to the subsequent property owner.

The lifetime coverage offered by this warranty for Grand Manor Shingle, Carriage House Shingle, Presidential Shake TL and Landmark TL automatically ceases not only upon sale of the property, but also upon the death of the last of the original owners of the property at the time of installation. In either event, the warranty will cover 40 years and CertainTeed's maximum contribution toward the cost of repairing or replacing the defective shingles will be calculated as explained in the above section titled "Beyond SureStart Protection."

For all other shingle products, if the warranty is transferred by the original consumer during the SureStart period, the duration of the warranty, measured from the date of installation, will remain the same as for the original consumer, and the remaining period of SureStart protection will be available to the subsequent property owner.

AFTER THE SURESTART PERIOD

In the event that the warranty is transferred by the original consumer subsequent to the SureStart period, the warranty duration following the transfer will be two years from the date of real estate title transfer, and the warranty obligation will be calculated as explained in the above section titled "Beyond SureStart Protection."

Limitations

This warranty provides protection against any shingle defects that arise in the course of ordinary and everyday wear and tear to the roof caused by normal exposure to the elements. It does not provide protection against damage caused by situations and events beyond normal exposure conditions, such as, but not limited to:

- winds, including gusts, greater than those listed in Table 1 for each product, lightning, hurricane (see Limited Wind Warranty for hurricane wind exception), tornado, hailstorm, earthquake, fire, explosion, flood or falling objects.
- distortion, cracking or other failure, or movement of the base material over which the shingles are applied, or of the roof deck, or of the walls or foundation of the building itself.
- damage caused by structural changes, alterations or additions, or by the installation of equipment (such as aerials, signs or air-conditioning equipment) to the structure after

the original shingles have been applied.

- stains or contamination to the shingle arising from sources such as, but not limited to, moss, lichens or other vegetation, or paints, chemicals or other similar materials, unless the applied asphalt shingle was sold as an "algae-resistant shingle," in which case CertainTeed will clean, repair or replace, at its option, per the terms of the warranty, only such shingles which are proven to be contaminated with algae during the term of the warranty against algae growth.
- improper storage of CertainTeed shingles.
- installation of shingles over non-approved roof decks as fully explained in the CertainTeed Shingle Applicator's Manual.
- damage to CertainTeed shingles, the roof deck or the structure caused by ice backup or ice damming.

If the applied shingles contain self-sealing asphalt strips, and if any of these strips fail to activate within the first year following application, CertainTeed shall have no liability under this warranty for such a defect unless CertainTeed is afforded the opportunity to hand-seal, at its sole expense, any non-sealing shingles.

CertainTeed reserves the right to discontinue or modify any of its products, including the color of the shingles, and shall not be liable as a result of such discontinuance or modification, nor shall CertainTeed be liable in the event replacement material may vary in color in comparison to the original product as a result of normal weathering. If CertainTeed replaces any material under this warranty, it may substitute products designated by CertainTeed to be of comparable quality or price range in the event the product initially installed has been discontinued or modified.

Inadequately Ventilated Roof Decks

This limited warranty (with no reduction in warranty duration) will apply under the following conditions to CertainTeed's "top-of-the-line" roofing shingles installed on commercial buildings without adequate ventilation installed directly beneath the shingled roof deck (and directly above the insulation):

1. Shingles must be among those covered in this limited warranty by a 40-year or longer warranty duration. Shingles with a lesser warranted life will qualify for only a 10-year warranty duration with respect to shingle problems related to the absence of adequate roof ventilation.
2. Only "Structural Insulated Panels" (SIPs) or "nailboard insulation panels" having either minimum 3/8" plywood or minimum 7/16" OSB on their top surface may be used as the substrate upon which the shingles are applied. Use of any other inadequately ventilated insulated substrate will limit the warranty duration to only 10 years with respect to shingle problems related to the absence of adequate roof ventilation.
3. Shingles must be applied to a non-residential building.
4. Appropriate insulation and vapor retarder, if necessary, must be installed in order to prevent deterioration of the roof deck or shingle substrate affecting either shingle appearance or shingle performance due to excessive moisture. It is the responsibility of the deck system manufacturer and/or deck system designer to choose the appropriate insulation and to determine the need for a vapor retarder.

Shingles installed on a private home or residence (as opposed to an apartment building, for example) will qualify for a warranty duration of only 10 years with respect to shingle problems related to the absence of adequate roof ventilation. This 10-year warranty duration applies even if CertainTeed's "top-of-the-line" shingles have been used.

In any instance in which the shingles qualify for only a 10-year warranty, CertainTeed's obligation will be calculated by using both the maximum material liability and pertinent monthly reduction figure shown in Table 1 related to shingles applied to an inadequately ventilated roof deck.

Limited Wind Warranty

CertainTeed warrants both its fiber glass asphalt shingles and its organic-base asphalt shingles to resist blow-off damage due to wind velocities, including gusts, up to 110 miles per hour (including hurricane winds) during the first ten (10) years following application for Grand Manor Shingle, Carriage House Shingle, Presidential Shake TL, Landmark TL and Haueras shingles and up to 90 miles per hour during the first ten (10) years following application for Presidential Shake. All other shingle products are warranted to resist blow-off damage due to wind velocities, including gusts, up to the maximum wind velocity per product listed in Table 1 during the first five (5) year period following application of the shingles. If any such blow-off damage does occur during those initial time periods after application, CertainTeed will furnish replacement shingles without charge for those shingles damaged (but will not be responsible for labor costs pertaining to removal or replacement of damaged shingles). However, in the event the shingles involved contain self-sealing asphalt strips, CertainTeed shall have no liability under this Limited Wind Warranty unless it is first afforded the opportunity to hand-seal, at its sole expense, any non-sealing asphalt strips which fail to activate within the first year after application.

Any costs in excess of CertainTeed's contribution shall be the owner's responsibility through homeowner's insurance, etc.

What the Customer Must Do

The property owner must promptly notify CertainTeed in writing of any manufacturing defect or algae contamination and provide proof of the date of purchase and date of application of the shingles. CertainTeed will then investigate the claim, and if a defect covered by this warranty is confirmed, CertainTeed, within a reasonable amount of time after the inspection, will repair, replace or clean the defective shingles or reimburse the property owner the appropriate amount for the repair, replacement or cleaning of the shingles under the terms of the warranty.

Notification should be sent to:

CertainTeed Corporation
1400 Union Meeting Road
Blue Bell, PA 19422
Attn: RPG Consumer Service Dept.
800-345-1145

This warranty, which is effective on shingles applied on or after November 1, 2001, supersedes the written warranty previously issued by CertainTeed coded No. 20-20-1725.

THIS WARRANTY REPLACES ALL OTHER ORAL OR WRITTEN WARRANTIES, LIABILITIES OR OBLIGATIONS OF CERTAINTEED. PERTINENT STATE LAW SHALL CONTROL FOR WHAT PERIOD OF TIME SUBSEQUENT TO SALE A CONSUMER/HOMEOWNER MAY SEEK A REMEDY PURSUANT TO THE IMPLIED WARRANTY OF MERCHANTABILITY OR FITNESS FOR A PARTICULAR PURPOSE. IN NO EVENT SHALL CERTAINTEED BE LIABLE FOR CONSEQUENTIAL OR INCIDENTAL DAMAGES OF ANY KIND, INCLUDING ANY DAMAGE TO THE BUILDING, ITS CONTENTS OR ANY PERSONS THEREIN, RESULTING FROM THE BREACH OF ANY WARRANTY SET FORTH HEREIN. NO FIELD REPRESENTATIVE, DISTRIBUTOR OR DEALER OF CERTAINTEED IS AUTHORIZED TO MAKE ANY CHANGE OR MODIFICATION TO THIS WARRANTY. SOME STATES DO NOT ALLOW LIMITATIONS ON OR THE EXCLUSION OF INCIDENTAL OR CONSEQUENTIAL DAMAGES, SO THE ABOVE EXCLUSIONS MAY NOT APPLY TO YOU.

This warranty gives you specific legal rights, and you may also have other rights that vary from state to state.

**CertainTeed Corporation
Roofing Products Group
P.O. Box 860
Valley Forge, PA 19482
800-345-1145**

This warranty, which is effective on shingles applied on or after November 1, 2002, supersedes the written warranty previously issued by CertainTeed coded No. 20-20-1821.

THIS WARRANTY REPLACES ALL OTHER ORAL OR WRITTEN WARRANTIES, LIABILITIES OR OBLIGATIONS OF CERTAINTEED. PERTINENT STATE LAW SHALL CONTROL FOR WHAT PERIOD OF TIME SUBSEQUENT TO SALE A CONSUMER/HOMEOWNER MAY SEEK A REMEDY PURSUANT TO THE IMPLIED WARRANTY OF MERCHANTABILITY OR FITNESS FOR A PARTICULAR PURPOSE. IN NO EVENT SHALL CERTAINTEED BE LIABLE FOR CONSEQUENTIAL OR INCIDENTAL DAMAGES OF ANY KIND, INCLUDING ANY DAMAGE TO THE BUILDING, ITS CONTENTS OR ANY PERSONS THEREIN, RESULTING FROM THE BREACH OF ANY WARRANTY SET FORTH HEREIN. NO FIELD REPRESENTATIVE, DISTRIBUTOR OR DEALER OF CERTAINTEED IS AUTHORIZED TO MAKE ANY CHANGE OR MODIFICATION TO THIS WARRANTY. SOME STATES DO NOT ALLOW LIMITATIONS ON OR THE EXCLUSION OF INCIDENTAL OR CONSEQUENTIAL DAMAGES, SO THE ABOVE EXCLUSIONS MAY NOT APPLY TO YOU.

This warranty gives you specific legal rights, and you may also have other rights that vary from state to state.

ROOFING PLANTS AND REGIONAL SALES OFFICES

CertainTeed roofing products are sold by the Roofing Products Group of CertainTeed Corporation in seven sales regions. They are manufactured in eleven residential roofing plants and two commercial roofing plants.

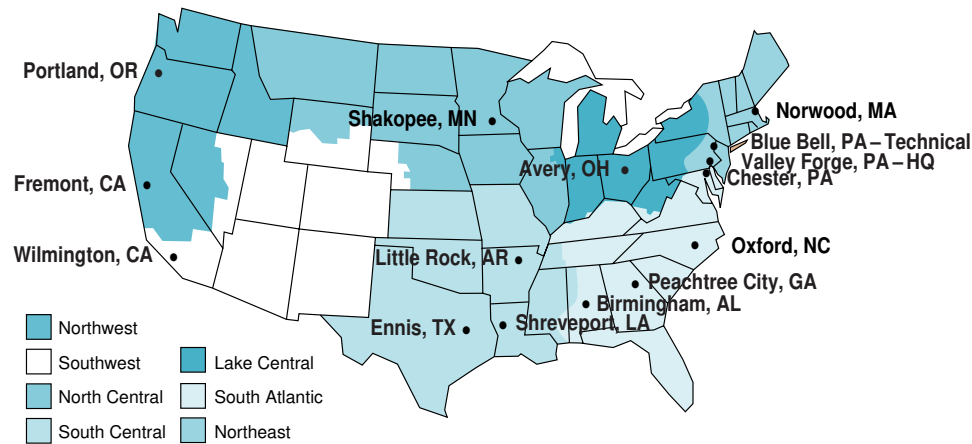

Since the early 1900s, CertainTeed Corporation has been an innovator in the building materials industry and today is a leading manufacturer of building materials including residential and commercial roofing, vinyl and fibercement siding, vinyl windows, composite decking and railing, ventilation products, fiber glass insulation, vinyl fence, deck and railing, and piping products. The company is headquartered in Valley Forge, Pennsylvania, and employs more than 7,000 employees at approximately 50 manufacturing facilities throughout North America. Continuing the 95-year commitment of "quality made *certain*, satisfaction *guaranteed*," CertainTeed remains one of the most trusted names in the industry. More information is available at www.certainteed.com.

CertainTeed Corporation
Roofing Products Group
P.O. Box 860
Valley Forge, PA 19482
800-345-1145

CertainTeed
Quality made certain. Satisfaction guaranteed.

© 2003 CertainTeed Corporation 20-20-1856

CertainTeed
SURESTART
2003

**ASPHALT
SHINGLE
PRODUCTS
LIMITED
WARRANTY
CERTAINTEED
CORPORATION**

THE
ROOFING
COLLECTION®
CertainTeed

This document is available in Spanish. Call 1-800-404-9880. (Note: the operators do not speak Spanish)
Se puede obtener este documento en español. Favor de llamar 1-800-404-9880. (los operadores no hablan español)

CONGRATULATIONS!

... and thank you for your recent purchase of one of the fine products in the CertainTeed Roofing Collection.™ Since 1904, CertainTeed has been producing quality roofing products that provide long-lasting beauty and protection for homes of every size, style and age. For the past 95 years, the basis for our name, “Quality made *certain*, satisfaction guaranteed,” has been our ongoing philosophy.

Your CertainTeed roofing warranty fully explains how CertainTeed supports its products with the strongest warranty protection available. In the following paragraphs we would like to highlight some of the more important warranty features, and provide some additional information that will help you understand why the quality of your CertainTeed roof is not just a claim, but a fact.

However, it is important that you read the warranty section of this brochure. The warranty lists the specific CertainTeed asphalt shingle products that are covered and the period of time for which they are covered. Take the time to understand how CertainTeed protects your purchase by standing behind our products.

SURESTART™ PROTECTION

Because CertainTeed roofing products are manufactured to the highest quality standards, we confidently include the additional assurance of SureStart™ protection with all CertainTeed shingles. SureStart provides the strongest protection you can get in the vital early years after your new roof has been installed.

Simply put, if a manufacturing defect is discovered during the SureStart period, CertainTeed will provide reimbursement of 100% of the cost of the shingles and labor to repair the defective shingles or apply new shingles to



replace the defective shingles (exclusive of costs of tear-off, metal work and disposal). SureStart protection is not prorated or otherwise reduced over time.

SureStart protection does not extend to any shingles applied to any non-ventilated roof deck systems.

The remaining period of SureStart protection will be available to the first subsequent property owner.

For product warranties transferred after the SureStart period has elapsed, the remaining duration of the transferred warranty will be limited to **two** years from the date of real estate title transfer.

TRANSFERABILITY

The warranty for CertainTeed shingles is transferable by the original property owner to the first subsequent owner. Upon transfer of the warranty during the product's SureStart period, the remaining duration of the warranty for the new owner is the same as it would have been for the original owner, except for lifetime products where the duration of the warranty will be 40 years measured from date of installation.

WHAT IS A “SHANGLE®”?

The “Shangle®,” an idea conceived by CertainTeed over 30 years ago, is the original “laminated shingle.” The Shangle features a full-size, one-piece shingle as a base, to which individual shingle tabs or overlay pads are applied, providing extra protection and aesthetic enhancement to the roof.

A *Super Shangle®* takes this idea one step further by using it on an 18" x 36" base layer, adding another full size shingle or another shingle layer and the shingle tags. *Super Shangles* feature deep shadow lines and a dramatic 8" exposure.

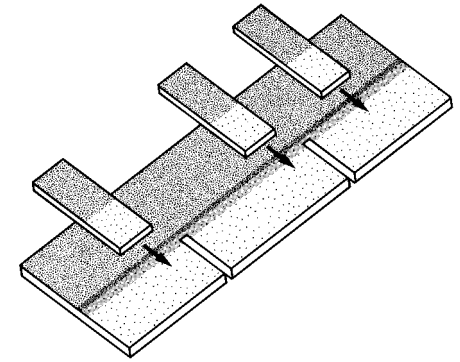

WHAT IS A TRI-LAMINATE™?

Our patented Tri-Laminate™ process combines three layers of the industry's most durable materials into an exceptionally strong, dramatically thick roofing product styled with the classic appeal of wood shakes. CertainTeed's stunning, 3-dimensional appearance of our Super Shake™ products gives your roof tremendous depth and distinction beyond comparison.

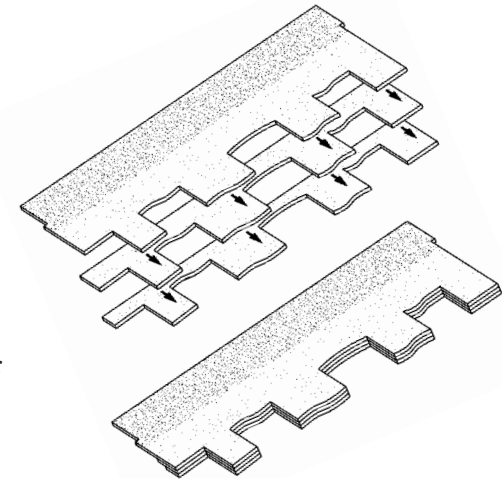

WHAT IS A TWO-PIECE LAMINATE?

Whereas a Shangle consists of a full-size, one-piece base shingle onto which tabs or pads are applied, a two-piece laminate uses a full-size shingle with tab-size teeth cut out of it. Adhered to the back of this top shingle is a half shingle that runs behind the cutouts. The result is a multi-layered shingle that provides a rugged, textured look on the roof.

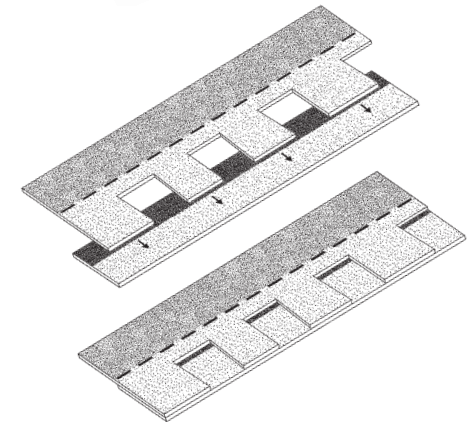

WHAT IS AN ALGAE-RESISTANT SHINGLE?

Many of CertainTeed's fiber glass shingles are available in an algae-resistant version. Commonly called (although incorrectly) "fungus," the black and green algae that creates unsightly streaking on shingles is a common occurrence in warm, humid climates.

CertainTeed AR shingles carry an exceptional 10- or 15-year limited warranty against algae contamination.



WHAT IS A SELF-SEALING STRIP?

Most shingles contain a factory applied self-sealing asphalt strip which must be subjected to direct sunlight for several days before sealing will occur. Shingles installed in the fall or winter may not seal until the following spring. Shingles which do not receive direct sunlight or which are not exposed to adequate surface temperatures may never seal and must be hand sealed at time of application. Shingles

which have not been properly installed, or damage to the factory applied self-sealing strip by dust, sand, or foreign matter will prevent the sealing strip from activating. Failure of the shingles to seal under any of the above circumstances is **not** a manufacturing defect and CertainTeed will not be responsible for repairing, replacing or hand-sealing any shingles under any such circumstance.

LIMITED WARRANTY

This warranty covers asphalt shingle products sold only in the United States of America, its territories and Canada.

What and Who Is Covered and for How Long

Provided shingles have been installed in strict accordance with CertainTeed's current written installation instructions, CertainTeed warrants to the original property owner/consumer that its asphalt roofing shingles will be free from manufacturing defects for the length of time specified in Table 1, and that CertainTeed will repair or replace any shingles proven to be defective under the terms of this warranty.

In addition, CertainTeed warrants that the Algae-Resistant versions of Grand Manor Shingle®, Carriage House Shingle™, Presidential Shake™ TL, Landmark™ TL and Presidential Shake™ AR will remain free from algae growth (but **not** mold growth) which adversely affects the overall appearance of said shingles for a period of fifteen (15) years, and that Independence Shingle® AR, Hatteras®, Landmark™ 50 AR, Landmark™ 40 AR, Landmark™ 30 AR, Firehalt™ AR, XT™ 30 AR, Patriot AR, XT™ 25 AR and CT 20 AR shingles that were sold as "algae-resistant shingles" will remain free from algae growth (but **not** mold growth) which adversely affects the overall appearance of said shingles for a period of ten (10) years. However, CertainTeed reserves the right to clean the algae stains from the shingles rather than repair or replace the contaminated shingles.

In the event of repair, replacement or cleaning pursuant to the terms of this warranty, the original warranty shall apply to the replacement shingles or the repaired or cleaned shingles and will extend for the balance of the warranty period in effect at the time the shingles proved defective.

The lifetime coverage for Grand Manor Shingle, Carriage House Shingle, Presidential Shake TL, and Landmark TL offered by this warranty is designed to cover individual homeowners only. In the instance of shingles purchased by or installed upon property owned by, for example, corporations, governmental agencies, partnerships, trusts, religious organizations, schools, condominiums or cooperative housing arrangements, or installed on apartment buildings or any other type of building or premises not used by individual homeowners as their residence, the warranty period for Grand Manor Shingle, Carriage House Shingle, Presidential Shake TL and Landmark TL will be 50 years following the installation of the shingles, and in all four instances CertainTeed's maximum liability after the SureStart period will be calculated using the figure indicated in Table 1 as the maximum material liability, exclusive of costs of labor, roof tear-off, metal work, and disposal, and by then decreasing that amount by the reduction figure specified in Table 1 for each month as measured from the date the shingles were installed to the date when proven defective.

SureStart™ Protection

All of CertainTeed's shingle products are covered by SureStart™ protection for the period specified in Table 1. Under this warranty feature, CertainTeed, at no charge, will repair or replace, at its option, any shingles proven to be defective during the applicable SureStart period (the SureStart period begins when shingle application has been

TABLE 1

Product	Warranty Period	SureStart™ Period	Wind Warranty MPH	Algae Resistant Warranty Period**	Maximum Material Liability After SureStart Period	Reduction Figure Per Month
GRAND MANOR SHINGLE®	LIFETIME	10 YEARS	110	15	\$140/Square	1/600*
CARRIAGE HOUSE SHINGLE™	LIFETIME	10 YEARS	110	15	\$110/Square	1/600*
PRESIDENTIAL SHAKE™ TL	LIFETIME	10 YEARS	110	15	\$140 Square	1/600*
LANDMARK™ TL	LIFETIME	10 YEARS	110	15	\$120/Square	1/600*
PRESIDENTIAL SHAKE™ (and AR)	50 YEARS	10 YEARS	90	15	\$95/Square	1/600
LANDMARK™ 50 (and AR)	50 YEARS	5 YEARS	90	10	\$55/Square	1/600
WOODSCAPE® 50	50 YEARS	5 YEARS	90	N/A	\$55/Square	1/600
INDEPENDENCE SHANGLE® (and AR)	50 YEARS	5 YEARS	90	10	\$55/Square	1/600
HATTERAS®	40 YEARS	5 YEARS	110	10	\$55/Square	1/480
LANDMARK™ 40 (and AR)	40 YEARS	5 YEARS	80	10	\$45/Square	1/480
WOODSCAPE® 40	40 YEARS	5 YEARS	80	N/A	\$45/Square	1/480
HALLMARK SHANGLE®	30 YEARS	5 YEARS	60	N/A	\$55/Square	1/360
CUSTOM SEALDON® 30	30 YEARS	5 YEARS	80	N/A	\$35/Square	1/360
XT™ 30 (and AR)	30 YEARS	5 YEARS	80	10	\$35/Square	1/360
LANDMARK™ 30 (and AR)	30 YEARS	5 YEARS	70††	10	\$40/Square	1/360
WOODSCAPE® 30	30 YEARS	5 YEARS	70††	N/A	\$40/Square	1/360
PATRIOT AR	30 YEARS	5 YEARS	80	10	\$40/Square	1/360
CLASSIC HORIZON SHANGLE®	25 YEARS	5 YEARS	60	N/A	\$40/Square	1/300
NEW HORIZON SHANGLE®	25 YEARS	5 YEARS	60	N/A	\$40/Square	1/300
HEARTHSTEAD®	25 YEARS	5 YEARS	60	N/A	\$35/Square	1/300
CUSTOM LOK™ 25	25 YEARS	5 YEARS	60	N/A	\$35/Square	1/300
XT™ 25 (and AR)	25 YEARS	5 YEARS	60	10	\$30/Square	1/300
SEALDON® 25	25 YEARS	5 YEARS	60	N/A	\$30/Square	1/300
FIREHALT™ (and AR)	25 YEARS	5 YEARS	60	10	\$40/Square	1/300
SEAL KING® 25	25 YEARS	5 YEARS	60	N/A	\$30/Square	1/300
JET® 25	25 YEARS	4 YEARS	60	N/A	\$30/Square	1/300
CT 20 (and AR)	20 YEARS	3 YEARS	60	10	\$25/Square	1/240
FIRESCREEN™	20 YEARS	3 YEARS	60	N/A	\$25/Square	1/240
ANY SHINGLES APPLIED TO ANY INADEQUATELY VENTILATED ROOF DECK	10 YEARS†	N/A	N/A	N/A	See Above	1/120

* For Grand Manor Shingle, Carriage House Shingle, Presidential Shake TL and Landmark TL, at the completion of the 40th year the reduction figure will remain at 480/600, or 20% of the total maximum liability.

** Algae-Resistant Warranty period cited is only applicable to Algae Resistant version of the pertinent shingle.

† For details of warranty coverage for shingles installed on inadequately ventilated roof decks on both residential and commercial buildings, see provisions on page 7 under "Limitations."

†† Landmark 30 and Woodscape 30 roof shingles shall be resistant to blow-off due to wind velocities, including gusts, up to a maximum of 80 miles per hour, during the first five (5) years following application, provided that the shingles are installed using six (6) fasteners per shingle.

completed and terminates at the end of the year indicated as its term of duration; i.e., the SureStart period for Independence Shingle terminates at the completion of its fifth year of service). CertainTeed's maximum material liability under SureStart will be equal to the reasonable cost to replace the defective shingles, plus labor. CertainTeed shall not be responsible or liable for costs of roof tear-off and disposal and of flashing and metal work (and repairs required by defects therein) except for Grand Manor Shingle, Carriage House Shingle, Presidential Shake TL and Landmark TL, for which CertainTeed's maximum liability will also include the cost of roof tear-off and disposal.

SureStart protection does not extend to any shingles applied to any inadequately ventilated roof deck systems upon which the shingles are attached. In the case of these shingles, CertainTeed's maximum contribution toward the cost of repairing, replacing or cleaning the defective shingles will be calculated using the figure indicated in Table 1 as the maximum material liability, exclusive of costs of labor, roof tear-off and disposal, and by then decreasing that amount by the reduction figure (related to shingles applied to an inadequately ventilated roof deck) for each month as measured from the date the shingles were installed to the date when proven defective.

(PLEASE REFER TO NEXT PAGE FOR REMAINDER OF WARRANTY, INCLUDING OTHER CONDITIONS.)

In instances in which CertainTeed, under the terms of this warranty, has agreed to pay the cost of labor required to repair, replace or clean defective or contaminated shingles, CertainTeed will provide reimbursement only upon receipt of a copy of the contractor's invoice or other written evidence of the completion of such work which CertainTeed, in its sole discretion, deems acceptable.

Beyond SureStart™ Protection

Should any shingles prove to be defective subsequent to the SureStart™ period, CertainTeed's maximum contribution toward the cost of repairing or replacing the defective shingles will be calculated using the figure indicated in Table 1 as the maximum material liability, exclusive of costs of labor, roof tear-off and disposal, and by then decreasing that amount by the specified reduction figure for each month as measured from the date the shingles were installed to the date when proven defective.

Transferability

DURING THE SURESTART PERIOD

This limited warranty may be transferred by the original consumer to the subsequent property owner.

With respect to Grand Manor Shingle, Carriage House Shingle, Presidential Shake TL and Landmark TL, if this warranty is effectively transferred during the ten (10) year SureStart period, the duration of the warranty will be 40 years measured from the date of installation, and the remaining period of SureStart protection will be available to the subsequent property owner.

The lifetime coverage offered by this warranty for Grand Manor Shingle, Carriage House Shingle, Presidential Shake TL and Landmark TL automatically ceases not only upon sale of the property, but also upon the death of the last of the original owners of the property at the time of installation. In either event, the warranty will cover 40 years and CertainTeed's maximum contribution toward the cost of repairing or replacing the defective shingles will be calculated as explained in the above section titled "Beyond SureStart Protection."

For all other shingle products, if the warranty is transferred by the original consumer during the SureStart period, the duration of the warranty, measured from the date of installation, will remain the same as for the original consumer, and the remaining period of SureStart protection will be available to the subsequent property owner.

AFTER THE SURESTART PERIOD

In the event that the warranty is transferred by the original consumer subsequent to the SureStart period, the warranty duration following the transfer will be two years from the date of real estate title transfer, and the warranty obligation will be calculated as explained in the above section titled "Beyond SureStart Protection."

Limitations

This warranty provides protection against any shingle defects that arise in the course of ordinary and everyday wear and tear to the roof caused by normal exposure to the elements. It does not provide protection against damage caused by situations and events beyond normal exposure conditions, such as, but not limited to:

- winds, including gusts, greater than those listed in Table 1 for each product, lightning, hurricane (see Limited Wind Warranty for hurricane wind exception), tornado, hailstorm, earthquake, fire, explosion, flood or falling objects.
- distortion, cracking or other failure, or movement of the base material over which the shingles are applied, or of the roof deck, or of the walls or foundation of the building itself.
- damage caused by structural changes, alterations or additions, or by the installation of equipment (such as aerials, signs or air-conditioning equipment) to the structure after the original shingles have been applied.
- stains or contamination to the shingle arising from sources such as, but not limited to, moss, lichens or other vegetation, or paints, chemicals or other similar materials, unless the applied asphalt shingle was sold as an "algae-resistant shingle," in which case CertainTeed will clean, repair or replace, at its option, per the terms of the warranty, only such shingles which are proven to be contaminated with algae during the term of the warranty against algae growth.
- improper storage of CertainTeed shingles.
- installation of shingles over non-approved roof decks as fully explained in the CertainTeed Shingle Applicator's Manual.
- damage to CertainTeed shingles, the roof deck or the structure caused by ice backup or ice damming.

If the applied shingles contain self-sealing asphalt strips, and if any of these strips fail to activate within the first year following application, CertainTeed shall have no liability under this warranty for such a defect unless CertainTeed is afforded the opportunity to hand-seal, at its sole expense, any non-sealing shingles.

CertainTeed reserves the right to discontinue or modify any of its products, including the color of the shingles, and shall not be liable as a result of such discontinuance or modification, nor shall CertainTeed be liable in the event replacement material may vary in color in comparison to the original product as a result of normal weathering. If CertainTeed replaces any material under this warranty, it may substitute products designated by CertainTeed to be of comparable quality or price range in the event the product initially installed has been discontinued or modified.

Inadequately Ventilated Roof Decks

This limited warranty (with no reduction in warranty duration) will apply under the following conditions to CertainTeed's "top-of-the-line" roofing shingles installed on commercial buildings without adequate ventilation installed directly beneath the shingled roof deck (and directly above the insulation):

1. Shingles must be among those covered in this limited warranty by a 40-year or longer warranty duration. Shingles with a lesser warranted life will qualify for only a 10-year warranty duration with respect to shingle problems related to the absence of adequate roof ventilation.
2. Only "Structural Insulated Panels" (SIPs) or "nailboard insulation panels" having either minimum 3/8" plywood or minimum 7/16" OSB on their top surface may be used as the substrate upon which the shingles are applied. Use of any other inadequately ventilated insulated substrate will limit the warranty duration to only 10 years with respect to shingle problems related to the absence of adequate roof ventilation.
3. Shingles must be applied to a non-residential building.
4. Appropriate insulation and vapor retarder, if necessary, must be installed in order to prevent deterioration of the roof deck or shingle substrate affecting either shingle appearance or shingle performance due to excessive moisture. It is the responsibility of the deck system manufacturer and/or deck system designer to choose the appropriate insulation and to determine the need for a vapor retarder.

Shingles installed on a private home or residence (as opposed to an apartment building, for example) will qualify for a warranty duration of only 10 years with respect to shingle problems related to the absence of adequate roof ventilation. This 10-year warranty duration applies even if CertainTeed's "top-of-the-line" shingles have been used.

In any instance in which the shingles qualify for only a 10-year warranty, CertainTeed's obligation will be calculated by using both the maximum material liability and pertinent monthly reduction figure shown in Table 1 related to shingles applied to an inadequately ventilated roof deck.

Limited Wind Warranty

CertainTeed warrants both its fiber glass asphalt shingles and its organic-base asphalt shingles to resist blow-off damage due to wind velocities, including gusts, up to 110 miles per hour (including hurricane winds) during the first ten (10) years following application for Grand Manor Shingle, Carriage House Shingle, Presidential Shake TL, Landmark TL and Hatteras shingles and up to 90 miles per hour (including hurricane winds) during the first ten (10) years following application for Presidential Shake. All other shingle products are warranted to resist blow-off damage due to wind velocities, including gusts, up to the maximum wind velocity per product listed in Table 1 (including hurricane winds where applicable) during the first five (5) year period following application of the shingles. If any such blow-off damage does occur during those initial time periods after application, CertainTeed will furnish replacement shingles without charge for those shingles damaged (but will not be responsible for labor costs pertaining to removal or replacement of damaged shingles). However, in the event the shingles involved contain self-sealing asphalt strips, CertainTeed shall have no liability under this Limited Wind Warranty unless it is first afforded the opportunity to hand-seal, at its sole expense, any non-sealing asphalt strips which fail to activate within the first year after application.

Any costs in excess of CertainTeed's contribution shall be the owner's responsibility through homeowner's insurance, etc.

What the Customer Must Do

The property owner must promptly notify CertainTeed in writing of any manufacturing defect or algae contamination and provide proof of the date of purchase and date of application of the shingles. CertainTeed will then investigate the claim, and if a defect covered by this warranty is confirmed, CertainTeed, within a reasonable amount of time after the inspection, will repair, replace or clean the defective shingles or reimburse the property owner the appropriate amount for the repair, replacement or cleaning of the shingles under the terms of the warranty.

Notification should be sent to: CertainTeed Corporation, 1400 Union Meeting Road, Blue Bell, PA 19422
Attn: RPG Technical Services Dept., 800-345-1145

Warranty Registration

CertainTeed would like to offer you a way to safeguard your investment by registering your product warranty on the CertainTeed Website at www.certainteed.com/warranty. Failure to register this warranty shall NOT void the warranty or any of its terms.

You will then receive a numbered registration confirmation by return e-mail that can be printed out and kept with this warranty document and your proof of purchase.

Product Purchased _____ Date of Installation _____
Roofing Contractor _____ Contractor's Phone No. _____

(PLEASE REFER TO BACK FOR REMAINDER OF WARRANTY, INCLUDING OTHER CONDITIONS.)



2004

**ASPHALT
SHINGLE
PRODUCTS
LIMITED
WARRANTY
CERTAINTEED
CORPORATION**

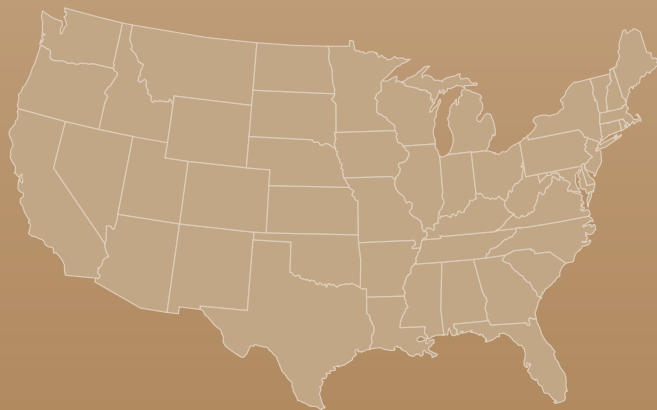

CertainTeed 

This document is available in Spanish. Call 1-800-404-9880. (Note: the operators do not speak Spanish)
Se puede obtener este documento en español. Favor de llamar 1-800-404-9880. (los operadores no hablan español)

CONGRATULATIONS!

... and thank you for your recent purchase of one of the fine products in the CertainTeed Roofing Collection™. Since 1904, CertainTeed has been producing quality roofing products that provide long-lasting beauty and protection for homes of every size, style and age. For the past 100 years, the basis for our name, “Quality made certain, satisfaction guaranteed,” has been our ongoing philosophy.

Your CertainTeed roofing warranty fully explains how CertainTeed supports its products with the strongest warranty protection available. In the following paragraphs we would like to highlight some of the more important warranty features, and provide some additional information that will help you understand why the quality of your CertainTeed roof is not just a claim, but a fact.



Celebrating a Century of Building America

However, it is important that you read the warranty section of this brochure. The warranty lists the specific CertainTeed asphalt shingle products that are covered and the period of time for which they are covered. Take the time to understand how CertainTeed protects your purchase by standing behind our products.

SURESTART™ PROTECTION

*B*ecause CertainTeed roofing products are manufactured to the highest quality standards, we confidently include the additional assurance of SureStart™ protection with all CertainTeed shingles. SureStart provides the strongest protection you can get in the vital early years after your new roof has been installed.

Simply put, if a manufacturing defect is discovered during the SureStart period, CertainTeed will provide reimbursement of 100% of the cost of the shingles and labor to repair the defective shingles or apply new shingles to replace the defective shingles (exclusive of costs of tear-off, metal work and disposal). SureStart protection is not prorated or otherwise reduced over time.

SureStart protection does not extend to any shingles applied to any non-ventilated roof deck systems.

TRANSFERABILITY

*T*he warranty for CertainTeed shingles is transferable by the original property owner/consumer to the first subsequent owner. Upon transfer of the warranty during the product's SureStart period, the remaining duration of the warranty for the new owner is the same as it would have been for the original owner, except for lifetime products where the duration of the warranty will be 50 years measured from date of installation.

The remaining period of SureStart protection will be available to the first subsequent property owner.

For product warranties transferred after the SureStart period has elapsed, the remaining duration of the transferred warranty will be limited to **two** years from the date of real estate title transfer.

WHAT IS A SELF-SEALING STRIP?

Most shingles contain a factory applied self-sealing asphalt strip which must be subjected to direct sunlight for several days before sealing will occur. Shingles installed in the fall or winter may not seal until the following spring. Shingles which do not receive direct sunlight or which are not exposed to adequate surface temperatures may never seal and must be hand sealed at time of application. Improper installation of shingles, or damage to the factory applied self-sealing strip by dust, sand, or foreign matter, will prevent the sealing strip from activating. Failure of the shingles to seal under any of the above circumstances is **not** a manufacturing defect and CertainTeed will not be responsible for repairing, replacing or hand-sealing any shingles under any such circumstance.

WHAT IS A “SHANGLE®”?

The “Shangle®,” an idea conceived by CertainTeed over 35 years ago, is the original “laminated shingle.” The Shangle features a full-size, one-piece shingle as a base, to which individual shingle tabs or overlay pads are applied, providing extra protection and aesthetic enhancement to the roof.

A *Super Shangle®* takes this idea one step further by using it on an 18" x 36" base layer, adding another shingle layer and the shingle tabs.

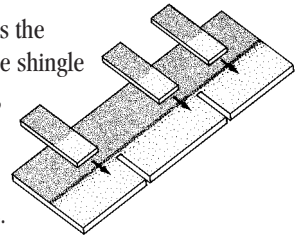

WHAT IS A TRI-LAMINATE™?

Our patented Tri-Laminate™ process combines three layers of the industry's most durable materials into an exceptionally strong, dramatically thick roofing product styled with the classic appeal of wood shakes. The stunning, 3-dimensional appearance of CertainTeed's Super Shake™ products gives your roof tremendous depth and distinction beyond comparison.

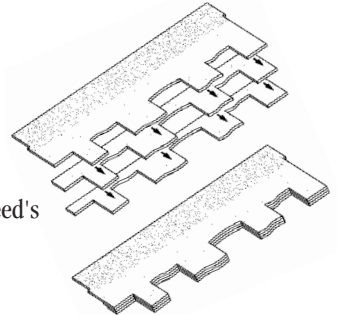

WHAT IS A TWO-PIECE LAMINATE?

Whereas a Shangle consists of a full-size, one-piece base shingle onto which tabs or pads are applied, a two-piece laminate uses a full-size shingle with tab-size teeth cut out of it. Adhered to the back of this top shingle is a half shingle that runs behind the cutouts. The result is a multi-layered shingle that provides a rugged, textured look on the roof.

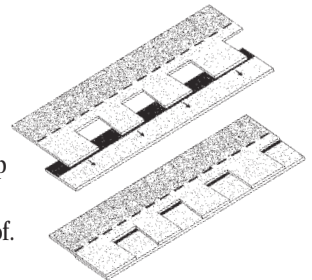

WHAT IS AN ALGAE-RESISTANT SHINGLE?

Many of CertainTeed's fiber glass shingles are available in an algae-resistant version. Commonly, although incorrectly, called “fungus,” the black and green algae that creates unsightly streaking on shingles is a common occurrence in warm, humid climates. CertainTeed AR shingles carry an exceptional 10- or 15-year limited warranty against algae contamination.

LIMITED WARRANTY

This warranty covers asphalt shingle products
sold only in the United States of America, its territories and Canada.

What and Who Is Covered and for How Long

Provided shingles have been installed in accordance with CertainTeed's current written installation instructions, CertainTeed warrants to the original property owner/consumer that its asphalt roofing shingles will be free from manufacturing defects for the length of time specified in Table 1, and that CertainTeed will repair or replace, at its option, any shingles proven to be defective under the terms of this warranty.

In addition, CertainTeed warrants that the Algae-Resistant versions of Grand Manor Shingle®, Centennial Slate™, Carriage House Shingle™, Presidential Shake™ TL, Landmark™ TL and Presidential Shake™ AR will remain free from algae growth (but **not** mold or mildew growth) which adversely affects the overall appearance of said shingles for a period of fifteen (15) years, and that Independence Shingle®AR, Hatteras®, Landmark™ 50 AR, Woodscape®50 AR, Landmark™ 40 AR, Landmark™ 40 IR, Landmark™ 30 AR, Woodscape®30 AR, Classic Horizon Shingle®AR, XT™30 AR, XT™30 IR, Patriot™AR, XT™ 25 AR/Seal King®25 AR and CT20 AR shingles that were sold as "algae-resistant shingles" will remain free from algae growth (but **not** mold or mildew growth) which adversely affects the overall appearance of said shingles for a period of ten (10) years. However, CertainTeed reserves the right to clean the algae stains from the shingles rather than repair or replace the contaminated shingles.

In the event of repair, replacement or cleaning pursuant to the terms of this warranty, the original warranty shall apply to the replacement shingles or the repaired or cleaned shingles and will extend for the balance of the warranty period in effect at the time the shingles proved defective.

The lifetime coverage for Grand Manor Shingle, Centennial Slate, Carriage House Shingle, Presidential Shake TL, and Landmark TL offered by this warranty is designed to cover individual homeowners only. In the instance of shingles purchased by or installed upon property owned by, for example, corporations, governmental agencies, partnerships, trusts, religious organizations, schools, condominiums or cooperative housing arrangements, or installed on apartment buildings or any other type of building or premises not used by individual homeowners as their residence, the warranty period for Grand Manor Shingle, Centennial Slate, Carriage House Shingle, Presidential Shake TL and Landmark TL will be 50 years following the installation of the shingles. Further, CertainTeed's maximum liability after the SureStart period will be calculated using the figure indicated in Table 1 as the maximum material liability, exclusive of costs of labor, roof tear-off, metal work, and disposal, and by then decreasing that amount by the reduction figure specified in Table 1 for each month as measured from the date the shingles were installed to the date when proven defective.

Flintlastic™ SA (Self-Adhering) System

For small low slope residential roofing projects – less than 20 squares (such as decks, additions and porches) – CertainTeed offers the following 10-year SureStart membrane warranty on our two-ply system consisting of Flintlastic™ SA Base and Flintlastic SA Cap sheet, providing the system has been installed in accordance with CertainTeed's current written installation instructions.

CertainTeed warrants the roof membrane for a period of 10 years from the date of completion of the roof membrane installation. During the duration of this warranty, CertainTeed will repair the roof membrane as necessary to retain the membrane in a watertight condition. Only leaks or other membrane deficiencies that result from manufacturing defects are covered by this warranty. CertainTeed and/or its designated roofing contractor will repair, at CertainTeed's expense, such leaks or other membrane deficiencies covered by the warranty as necessary to retain the roof membrane in a watertight condition. CertainTeed is not responsible for any costs related to the removal or abatement of any asbestos present in any existing roofing system to which the CertainTeed roofing membrane is applied. The roof membrane referred to herein shall include the following components: a base sheet and a cap sheet applied per CertainTeed published specifications. Included among the roof components which are not part of the roof membrane and hence NOT covered by this warranty are the following: underlying roof deck, insulation, vapor retarders, fasteners, metal work, drains, skylights, vents, plastic accessories, any flashing, decorative or reflective coating, surfacing and/or any ballast, rock or gravel.

SureStart™ Protection

All of CertainTeed's shingle products are covered by SureStart™ protection for the period specified in Table 1. Under this warranty feature, CertainTeed, at no charge, will repair or replace, at its option, any shingles proven to be defective during the applicable SureStart period (the SureStart period begins when shingle application has been completed and terminates at the end of the year indicated as its term of duration; i.e., the SureStart period for Independence Shingle terminates at the completion of its fifth year of service). CertainTeed's maximum material liability under SureStart will be equal to the reasonable cost to replace the defective shingles, plus labor. CertainTeed shall not be responsible or liable

TABLE I

Product	Warranty Period	SureStart™ Period	Wind Warranty MPH	Algae Resistant Warranty Period**	Maximum Material Liability After SureStart Period	Reduction Figure Per Month
GRAND MANOR SHANGLE®	LIFETIME	10 YEARS	110	15	\$140/Square	1/600*
CENTENNIAL SLATE™	LIFETIME	10 YEARS	110	15	\$140/Square	1/600*
CARRIAGE HOUSE SHANGLE™	LIFETIME	10 YEARS	110	15	\$110/Square	1/600*
PRESIDENTIAL SHAKE™ TL	LIFETIME	10 YEARS	110	15	\$140 Square	1/600*
LANDMARK™ TL	LIFETIME	10 YEARS	110	15	\$120/Square	1/600*
PRESIDENTIAL SHAKE™ (and AR)	50 YEARS	10 YEARS	110	15	\$95/Square	1/600
LANDMARK™ 50 (and AR)	50 YEARS	5 YEARS	90††	10	\$55/Square	1/600
WOODSCAPE® 50 AR	50 YEARS	5 YEARS	90††	10	\$55/Square	1/600
INDEPENDENCE SHANGLE® (and AR)	50 YEARS	5 YEARS	110	10	\$55/Square	1/600
HATTERAS®	40 YEARS	5 YEARS	110	10	\$55/Square	1/480
LANDMARK™ 40 (and AR) (and IR)	40 YEARS	5 YEARS	80††	10	\$45/Square	1/480
HALLMARK SHANGLE®	40 YEARS	5 YEARS	80	N/A	\$55/Square	1/360
CUSTOM SEALDON® 30	30 YEARS	5 YEARS	80	N/A	\$35/Square	1/360
XT™ 30 (and AR) (and IR)	30 YEARS	5 YEARS	80	10	\$35/Square	1/360
LANDMARK™ 30 (and AR)	30 YEARS	5 YEARS	70††	10	\$40/Square	1/360
WOODSCAPE® 30 AR	30 YEARS	5 YEARS	70††	10	\$40/Square	1/360
PATRIOT™ AR	30 YEARS	5 YEARS	60	10	\$40/Square	1/360
CLASSIC HORIZON SHANGLE® (and AR)	30 YEARS	5 YEARS	70	10	\$40/Square	1/360
NEW HORIZON SHANGLE®	30 YEARS	5 YEARS	70	N/A	\$40/Square	1/360
HEARTHSTEAD®	25 YEARS	5 YEARS	60	N/A	\$35/Square	1/300
CUSTOM LOK™ 25	25 YEARS	5 YEARS	60	N/A	\$35/Square	1/300
XT™ 25 (and AR)/Seal King® 25 AR	25 YEARS	5 YEARS	60	10	\$30/Square	1/300
SEALDON® 25	25 YEARS	5 YEARS	60	N/A	\$30/Square	1/300
JET® 25	25 YEARS	4 YEARS	60	N/A	\$30/Square	1/300
CT 20 (and AR)	20 YEARS	3 YEARS	60	10	\$25/Square	1/240
ANY SHINGLES APPLIED TO ANY INADEQUATELY VENTILATED ROOF DECK	10 YEARS†	N/A	N/A	N/A	See Above	1/120

* For Grand Manor Shingle, Centennial Slate, Carriage House Shingle, Presidential Shake TL and Landmark TL, at the completion of the 40th year the reduction figure will remain at 480/600, or 20% of the total maximum liability.

** Algae Resistant Warranty period cited is only applicable to Algae Resistant version of the pertinent shingle.

† For details of warranty coverage for shingles installed on inadequately ventilated roof decks on both residential and commercial buildings, see provisions on page 7 under "Limitations."

†† Laminated wind warranty upgrade. Roof shingles shall be resistant to blow-off due to wind velocities, including gusts, up to a maximum of 110 miles per hour for Landmark 50 and Woodscape 50, 90 mph for Landmark 40 and 80 mph for Landmark 30 and Woodscape 30, during the first five (5) years following application, provided that the shingles are installed using six (6) fasteners, in the common bond area, per shingle.

CertainTeed warrants that Landmark 40 IR and XT30 IR are compliant with UL 2218 Impact Resistance of Prepared Roof Covering Materials test criteria at time of manufacture.

for costs of roof tear-off and disposal and of flashing and metal work (and repairs required by defects therein) except for Grand Manor Shingle, Centennial Slate, Carriage House Shingle, Presidential Shake TL and Landmark TL, for which CertainTeed's maximum liability will also include the cost of roof tear-off and disposal.

SureStart protection does not extend to any shingles applied to any inadequately ventilated roof deck systems upon which the shingles are attached. In the case of these shingles, CertainTeed's maximum contribution toward the cost of repairing, replacing or cleaning the defective shingles will be calculated using the figure indicated in Table 1 as the maximum material liability, exclusive of costs of labor, roof tear-off and disposal, and by then decreasing that amount by the reduction figure (related to shingles applied to an inadequately ventilated roof deck) for each month as measured from the date the shingles were installed to the date when proven defective.

In instances in which CertainTeed, under the terms of this warranty, has agreed to pay the cost of labor required to repair, replace or clean defective or contaminated shingles, CertainTeed will provide reimbursement only upon receipt of a copy of the contractor's invoice or other written evidence of the completion of such work which CertainTeed, in its sole discretion, deems acceptable.

Please refer to next page for remainder of warranty, including other conditions.

Beyond SureStart™ Protection

Should any shingles prove to be defective subsequent to the SureStart™ period, CertainTeed's maximum contribution toward the cost of repairing or replacing the defective shingles will be calculated using the figure indicated in Table 1 as the maximum material liability, exclusive of costs of labor, roof tear-off and disposal, and by then decreasing that amount by the specified reduction figure for each month as measured from the date the shingles were installed to the date when proven defective.

Transferability

DURING THE SURESTART PERIOD

This limited warranty may be transferred by the original property owner/consumer to the first subsequent property owner.

With respect to Grand Manor Shingle, Centennial Slate, Carriage House Shingle, Presidential Shake TL and Landmark TL, if this warranty is effectively transferred during the ten (10) year SureStart period, the duration of the warranty will be 50 years measured from the date of installation, and the remaining period of SureStart protection will be available to the subsequent property owner.

For all other shingle products, if the warranty is transferred by the original property owner/consumer during the SureStart period, the duration of the warranty, measured from the date of installation, will remain the same as for the original property owner/consumer, and the remaining period of SureStart protection will be available to the subsequent property owner.

AFTER THE SURESTART PERIOD

In the event that the warranty is transferred by the original property owner/consumer subsequent to the SureStart period, the warranty duration following the transfer will be two years from the date of real estate title transfer, and the warranty obligation will be calculated as explained in the above section titled "Beyond SureStart Protection."

Limitations

This warranty provides protection against any shingle defects that arise in the course of ordinary and everyday wear and tear to the roof caused by normal exposure to the elements. It does not provide protection against damage caused by situations and events beyond normal exposure conditions, such as, but not limited to:

- winds, including gusts, greater than those listed in Table 1 for each product, lightning, hurricane (see Limited Wind Warranty for hurricane wind exception), tornado, hailstorm, earthquake, fire, explosion, flood or falling objects.
- distortion, cracking or other failure, or movement of the base material over which the shingles are applied, or of the roof deck, or of the walls or foundation of the building itself.
- damage caused by structural changes, alterations or additions, or by the installation of equipment (such as aerials, signs or air-conditioning equipment) to the structure after the original shingles have been applied.
- stains or contamination to the shingle arising from sources such as, but not limited to, moss, lichens or other vegetation, mold or mildew growth, or paints, chemicals or other similar materials, unless the applied asphalt shingle was sold as an "algae resistant shingle," in which case CertainTeed will clean, repair or replace, at its option, per the terms of the warranty, only such shingles which are proven to be contaminated with algae during the term of the warranty against algae growth.
- misuse, abuse or improper handling or storage of CertainTeed shingles.
- installation of shingles over non-approved roof decks as fully explained in the CertainTeed *Shingle Applicator's Manual*.
- damage to CertainTeed shingles, the roof deck or the structure caused by ice backup or ice damming.
- improper application or application not in accordance with CertainTeed's current written installation instructions.

Mold and mildew are functions of environmental conditions and are not manufacturing defects. As such, mold and mildew are not covered by this warranty or any implied warranty.

CertainTeed reserves the right to discontinue or modify any of its products, including the color of the shingles, and shall not be liable as a result of such discontinuance or modification, nor shall CertainTeed be liable in the event replacement material varies in color in comparison to the original product as a result of normal weathering. If CertainTeed replaces any material under this warranty, it may substitute products designated by CertainTeed to be of comparable quality or price range in the event the product initially installed has been discontinued or modified.

If you live in a coastal area where salt fog occurs on a frequent basis, but rain only occurs on an infrequent basis, you should not use aluminum gutters on buildings that are roofed with algae resistant shingle products containing copper granules. Under these unique climatic conditions, the interaction of the copper in the granules with the aluminum in the gutters can destroy the gutters.

CertainTeed disclaims all liability and responsibility for any damages that may be incurred by the use of its algae resistant shingle products containing copper granules where aluminum gutters are used.

Inadequately Ventilated Roof Decks

This limited warranty (with no reduction in warranty duration) will apply under the following conditions to CertainTeed's "top-of-the-line" roofing shingles installed on commercial buildings without adequate ventilation installed directly beneath the shingled roof deck (and directly above the insulation):

1. Shingles must be among those covered in this limited warranty by a 40-year or longer warranty duration. Shingles with a lesser warranted life will qualify for only a 10-year warranty duration with respect to shingle problems related to the absence of adequate roof ventilation.
2. Only "Structural Insulated Panels" (SIPs) or "nailboard insulation panels" having either minimum 3/8" plywood or minimum 7/16" OSB on their top surface may be used as the substrate upon which the shingles are applied. Use of any other inadequately ventilated insulated substrate will limit the warranty duration to only 10 years with respect to shingle problems related to the absence of adequate roof ventilation.
3. Shingles must be applied to a non-residential building.
4. Appropriate insulation and vapor retarder, if necessary, must be installed in order to prevent deterioration of the roof deck or shingle substrate affecting either shingle appearance or shingle performance due to excessive moisture. It is the responsibility of the deck system manufacturer and/or deck system designer to choose the appropriate insulation and to determine the need for a vapor retarder.

Shingles installed on a private home or residence (as opposed to an apartment building, for example) will qualify for a warranty duration of only 10 years with respect to shingle problems related to the absence of adequate roof ventilation. This 10-year warranty duration applies even if CertainTeed's "top-of-the-line" shingles have been used.

In any instance in which the shingles qualify for only a 10-year warranty, CertainTeed's obligation will be calculated by using both the maximum material liability and applicable monthly reduction figure shown in Table 1 related to shingles applied to an inadequately ventilated roof deck.

Limited Wind Warranty

CertainTeed warrants both its fiber glass asphalt shingles and its organic-base asphalt shingles to resist blow-off damage due to wind velocities, including gusts, and including hurricane winds where applicable (over 75 mph) during the first ten (10) years following application for Grand Manor Shingle, Centennial Slate, Carriage House Shingle, Presidential Shake TL, Landmark TL, Presidential Shake and Hatteras shingles. All other shingle products are warranted to resist blow-off damage due to wind velocities, including gusts, up to the maximum wind velocity per product listed in Table 1 (including hurricane winds where applicable) during the first five (5) year period following application of the shingles.

If any such blow-off damage does occur during those initial time periods after application, CertainTeed will furnish replacement shingles without charge for those shingles damaged (but will not be responsible for labor costs pertaining to removal or replacement of damaged shingles). If the applied shingles contain self-sealing asphalt strips, and if any of these strips fail to activate within the first year following application, CertainTeed shall have no liability under this warranty for such a defect unless CertainTeed is afforded the opportunity to hand-seal, at its expense, any non-sealing shingles.

Any costs in excess of CertainTeed's contribution shall be the owner's responsibility through homeowner's insurance, etc.

What the Customer Must Do

The property owner must promptly notify CertainTeed in writing of any manufacturing defect or algae contamination and provide proof of the date of purchase and date of application of the shingles. CertainTeed will then investigate the claim, and if a defect covered by this warranty is confirmed, CertainTeed, within a reasonable amount of time after the inspection, will repair, replace or clean the defective shingles or reimburse the property owner the appropriate amount for the repair, replacement or cleaning of the shingles under the terms of the warranty.

All notifications should be sent to: CertainTeed, 1400 Union Meeting Road, Blue Bell, PA 19422
Attn: RPG Technical Services Department,
Telephone number: 800-345-1145

Warranty Registration (not required)

CertainTeed would like to offer you a way to safeguard your investment by registering your product warranty on the CertainTeed Website at www.certainteed.com/warranty. You will then receive a numbered registration confirmation by return e-mail that can be printed out and kept with this warranty document and your proof of purchase. Failure to register this warranty shall NOT void the warranty or any of its terms. **For those without internet access please feel free to provide us with your complete name, address and phone number; the name and contact information for your roofing contractor and the name of the shingle, number of squares, color and installation date.** We will register the information for you and mail you the confirmation.

**Mail to CertainTeed Corporation, Roofing Products Group
P.O. Box 860, Valley Forge, PA 19482.**

Please refer to next page for remainder of warranty, including other conditions.

FOR YOUR RECORDS ONLY:

Product Purchased _____ Date of Installation _____

Roofing Contractor _____ Contractor's Phone No. _____

This warranty, which is effective on shingles applied on or after January 1, 2004, supersedes the written warranty previously issued by CertainTeed coded No. 20-20-1856.

THIS WARRANTY REPLACES ALL OTHER ORAL OR WRITTEN WARRANTIES, LIABILITIES OR OBLIGATIONS OF CERTAINTEED. APPLICABLE STATE LAW WILL DETERMINE THE PERIOD OF TIME FOLLOWING THE SALE THAT A PROPERTY OWNER/CONSUMER MAY SEEK A REMEDY UNDER THE IMPLIED WARRANTY OF MERCHANTABILITY OR FITNESS FOR A PARTICULAR PURPOSE. IN NO EVENT SHALL CERTAINTEED BE LIABLE FOR CONSEQUENTIAL OR INCIDENTAL DAMAGES OF ANY KIND, INCLUDING ANY DAMAGE TO THE BUILDING, ITS CONTENTS OR ANY PERSONS THEREIN, RESULTING FROM THE BREACH OF THIS WARRANTY. NO FIELD REPRESENTATIVE, DISTRIBUTOR OR DEALER OF CERTAINTEED IS AUTHORIZED TO CHANGE OR MODIFY THIS WARRANTY. SOME STATES DO NOT ALLOW THE EXCLUSION OR LIMITATION OF INCIDENTAL OR CONSEQUENTIAL DAMAGES, SO THE ABOVE EXCLUSIONS MAY NOT APPLY TO YOU.

This warranty gives you specific legal rights, and you may also have other rights that vary from state to state.

ROOFING PLANTS AND REGIONAL SALES OFFICES

CertainTeed roofing products are sold by the Roofing Products Group of CertainTeed Corporation in seven sales regions. They are manufactured in eleven residential roofing plants and two commercial roofing plants.



Since the early 1900s, CertainTeed Corporation has been an innovator in the building materials industry and today is a leading manufacturer of building materials including residential and commercial roofing, vinyl and fiber cement siding, vinyl windows, composite decking and railing, fiber glass insulation, vinyl fence, and piping products. The company is headquartered in Valley Forge, Pennsylvania, and employs more than 7,000 employees at approximately 50 manufacturing facilities throughout North America. Continuing the 100 year commitment of "quality made *certain*, satisfaction guaranteed." CertainTeed remains one of the most trusted names in the industry. More information is available at www.certainteed.com.

CertainTeed Corporation
Roofing Products Group
P.O. Box 860 • Valley Forge, PA 19482
800-345-1145

CertainTeed 

Quality made certain. Satisfaction guaranteed.

© 2004 CertainTeed Corporation 20-20-1890
9/04



2005

**ASPHALT
SHINGLE
PRODUCTS
LIMITED
WARRANTY
CERTAINTEED
CORPORATION**

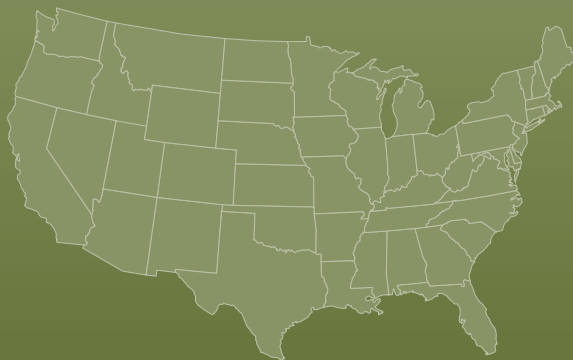

CertainTeed 

This document is available in Spanish. Call 1-800-404-9880. (Note: The operators do not speak Spanish.)
Se puede obtener este documento en español. Favor de llamar 1-800-404-9880. (Los operadores no hablan español.)

CONGRATULATIONS!

... and thank you for your recent purchase of one of the fine products in the CertainTeed Roofing Collection™. Since 1904, CertainTeed has been producing quality roofing products that provide long-lasting beauty and protection for homes of every size, style and age. For the past 100 years, the basis for our name, “Quality made *certain*, satisfaction guaranteed,” has been our ongoing philosophy.



Celebrating a Century of Building America

Your CertainTeed roofing warranty fully explains how CertainTeed supports its products with the strongest warranty protection available. It is important that you read the warranty section of this brochure. The warranty lists the specific CertainTeed asphalt shingle products that are covered and the period of time for which they are covered. Take the time to understand how CertainTeed protects your purchase by standing behind our products.

SURESTART™ PROTECTION

Because CertainTeed roofing products are manufactured to the highest quality standards, we confidently include the additional assurance of SureStart™ protection with all CertainTeed shingles. SureStart provides the strongest protection you can get in the vital early years after your new roof has been applied.

Simply put, if a manufacturing defect is discovered during the SureStart period, CertainTeed will provide reimbursement of 100% of the cost of the shingles and labor to repair the defective shingles or apply new shingles to replace the defective shingles (exclusive of costs of tear-off, metal work and disposal). SureStart protection is not prorated or otherwise reduced over time.

SureStart protection does not extend to any shingles applied to any non-ventilated or inadequately ventilated roof deck systems, except as stated on page 6.

TRANSFERABILITY

The warranty for CertainTeed shingles is transferable by the original property owner/consumer to the first subsequent owner. Upon transfer of the warranty during the product's SureStart period, the remaining duration of the warranty for the new owner is the same as it would have been for the original owner, except for lifetime products where the duration of the warranty will be 50 years measured from date of installation.

The remaining period of SureStart protection will be available to the first subsequent property owner.

For product warranties transferred after the SureStart period has elapsed, the remaining duration of the transferred warranty will be limited to **two** years from the date of real estate title transfer.

LIMITED WARRANTY

This warranty covers asphalt shingle products sold only in the United States of America, its territories and Canada.

What and Who Is Covered and for How Long

CertainTeed warrants to the original property owner/consumer that its asphalt roofing shingles will be free from manufacturing defects for the length of time specified in Table 1, and that CertainTeed will repair or replace, at its option, any shingles proven to be defective under the terms of this warranty.

In addition, CertainTeed warrants that the Algae-Resistant versions of Grand Manor Shingle®, Centennial Slate™, Carriage House Shingle™, Presidential Shake™ TL, Landmark™ TL and Presidential Shake™ AR will remain free from algae growth (but **not** mold or mildew growth) which adversely affects the overall appearance of said shingles for a period of fifteen (15) years, and that Independence Shingle®AR, Hatteras®, Landmark™ 50 AR, Woodscape®50 AR, Landmark™40 AR, Landmark™ 40 IR, Landmark™30 AR, Woodscape®30 AR, Classic Horizon Shingle®AR, XT™30 AR, XT™30 IR, Patriot™AR, XT™ 25 AR/Seal King®25 AR and CT20 AR shingles that were sold as “algae-resistant shingles” will remain free from algae growth (but **not** mold or mildew growth) which adversely affects the overall appearance of said shingles for a period of ten (10) years. However, CertainTeed reserves the right to clean the algae stains from the shingles rather than repair or replace the contaminated shingles.

In the event of repair, replacement or cleaning pursuant to the terms of this warranty, the original warranty shall apply to the replacement shingles or the repaired or cleaned shingles and will extend for the balance of the warranty period in effect at the time the shingles proved defective.

The lifetime coverage for Grand Manor Shingle, Centennial Slate, Carriage House Shingle, Presidential Shake TL, and Landmark TL offered by this warranty is designed to cover individual homeowners only. In the instance of shingles purchased by or installed upon property owned by, for example, corporations, governmental agencies, partnerships, trusts, religious organizations, schools, condominiums or cooperative housing arrangements, or installed on apartment buildings or any other type of building or premises not used by individual homeowners as their residence, the warranty period for Grand Manor Shingle, Centennial Slate, Carriage House Shingle, Presidential Shake TL and Landmark TL will be 50 years following the installation of the shingles. Further, CertainTeed’s maximum liability after the SureStart period will be calculated using the figure indicated in Table 1 as the maximum material liability, exclusive of costs of labor, roof tear-off, metal work, and disposal, and by then decreasing that amount by the reduction figure specified in Table 1 for each month as measured from the date the shingles were installed to the date when proven defective.

SureStart™ Protection

All of CertainTeed’s shingle products are covered by SureStart™ protection for the period specified in Table 1. Under this warranty feature, CertainTeed, at no charge, will repair or replace, at its option, any shingles proven to be defective during the applicable SureStart period (the SureStart period begins when shingle application has been completed and terminates at the end of the year indicated as its term of duration; i.e., the SureStart period for Independence Shingle terminates at the completion of its fifth year of service). CertainTeed’s maximum material liability under SureStart will be equal to the reasonable cost to replace the defective shingles, plus labor. CertainTeed shall not be responsible or liable for costs of roof tear-off and disposal and of flashing and metal work (and repairs required by defects therein) except for Grand Manor Shingle, Centennial Slate, Carriage House Shingle, Presidential Shake TL and Landmark TL, for which CertainTeed’s maximum liability will also include the cost of roof tear-off and disposal.

SureStart protection does not extend to any shingles applied to any non-ventilated or inadequately ventilated roof deck systems, except as stated on page 6. In the case of these shingles, CertainTeed’s maximum contribution toward the cost of repairing, replacing or cleaning the defective shingles will be calculated using the figure indicated in Table 1 as the maximum material liability, exclusive of costs of labor, roof tear-off and disposal, and by then decreasing that amount by the reduction figure (related to shingles applied to an inadequately ventilated roof deck) for each month as measured from the date the shingles were installed to the date when proven defective.

In instances in which CertainTeed, under the terms of this warranty, has agreed to pay the cost of labor required to repair, replace or clean defective or contaminated shingles, CertainTeed will provide reimbursement only upon receipt of a copy of the contractor’s invoice or other written evidence of the completion of such work which CertainTeed, in its sole discretion, deems acceptable.

Flintlastic™ SA (Self-Adhering) System

For small low slope residential roofing projects – less than 20 squares (such as decks, additions and porches) – CertainTeed offers the following 10-year SureStart membrane warranty on our two-ply system consisting of Flintlastic™ SA Base and Flintlastic SA Cap sheet, providing the system has been applied in accordance with CertainTeed’s current written installation instructions.

Please refer to next page for remainder of warranty, including other conditions.

TABLE I

Product	Warranty Period	SureStart™ Period	Wind Warranty MPH	Algae Resistant Warranty Period**	Maximum Material Liability After SureStart Period	Reduction Figure Per Month
GRAND MANOR SHANGLE®	LIFETIME	10 YEARS	110	15	\$140/Square	1/600*
CENTENNIAL SLATE™	LIFETIME	10 YEARS	110	15	\$130/Square	1/600*
CARRIAGE HOUSE SHANGLE™	LIFETIME	10 YEARS	110	15	\$110/Square	1/600*
PRESIDENTIAL SHAKE™ TL (and AR)	LIFETIME	10 YEARS	110	15	\$140 Square	1/600*
LANDMARK™ TL (and AR)	LIFETIME	10 YEARS	110	15	\$120/Square	1/600*
PRESIDENTIAL SHAKE™ (and AR)	50 YEARS	10 YEARS	110	15	\$95/Square	1/600
LANDMARK™ 50 (and AR)	50 YEARS	5 YEARS	90††	10	\$55/Square	1/600
WOODSCAPE® 50 AR	50 YEARS	5 YEARS	90††	10	\$55/Square	1/600
INDEPENDENCE SHANGLE® (and AR)	50 YEARS	5 YEARS	110	10	\$55/Square	1/600
HATTERAS®	40 YEARS	5 YEARS	110	10	\$55/Square	1/480
LANDMARK™ 40 (and AR) (and IR)	40 YEARS	5 YEARS	80††	10	\$45/Square	1/480
HALLMARK SHANGLE®	40 YEARS	5 YEARS	80	N/A	\$55/Square	1/480
XT™ 30 (and AR) (and IR)	30 YEARS	5 YEARS	70	10	\$35/Square	1/360
LANDMARK™ 30 (and AR)	30 YEARS	5 YEARS	70††	10	\$40/Square	1/360
WOODSCAPE® 30 AR	30 YEARS	5 YEARS	70††	10	\$40/Square	1/360
PATRIOT™ AR	30 YEARS	5 YEARS	70	10	\$40/Square	1/360
CLASSIC HORIZON SHANGLE® (and AR)	30 YEARS	5 YEARS	70	10	\$40/Square	1/360
NEW HORIZON SHANGLE®	30 YEARS	5 YEARS	70	N/A	\$40/Square	1/360
HEARTHSTEAD®	25 YEARS	5 YEARS	60	N/A	\$35/Square	1/300
CUSTOM LOK™ 25	25 YEARS	5 YEARS	60	N/A	\$35/Square	1/300
XT™ 25 (and AR)/Seal King® 25 AR	25 YEARS	5 YEARS	60	10	\$30/Square	1/300
SEALDON® 25	25 YEARS	5 YEARS	60	N/A	\$30/Square	1/300
JET® 25	25 YEARS	4 YEARS	60	N/A	\$30/Square	1/300
CT20 (and AR)	20 YEARS	3 YEARS	60	10	\$25/Square	1/240
ANY SHINGLES APPLIED TO ANY INADEQUATELY VENTILATED ROOF DECK	10 YEARS†	N/A	N/A	N/A	See Above	1/120

* For Grand Manor Shangle, Centennial Slate, Carriage House Shangle, Presidential Shake TL and Landmark TL, at the completion of the 40th year the reduction figure will remain at 480/600, or 20% of the total maximum liability.

** Algae Resistant Warranty period cited is only applicable to Algae Resistant version of the pertinent shingle.

† For details of warranty coverage for shingles installed on inadequately ventilated roof decks on both residential and commercial buildings, see provisions on page 6 under "Inadequately Ventilated and Non-Ventilated Decks."

†† Laminate wind warranty upgrade. Roof shingles shall be resistant to blow-off due to wind velocities, including gusts, up to a maximum of 110 miles per hour for Landmark 50 and Woodscape 50, 90 mph for Landmark 40 and 80 mph for Landmark 30 and Woodscape 30, during the first five (5) years following application, provided that the shingles are installed using six (6) fasteners, in the common bond area, per shingle.

CertainTeed warrants that Landmark 40 IR and XT30 IR are compliant with UL 2218 Impact Resistance of Prepared Roof Covering Materials test criteria at time of manufacture.

CertainTeed warrants the roof membrane for a period of 10 years from the date of completion of the roof membrane installation. During the duration of this warranty, CertainTeed will repair the roof membrane as necessary to retain the membrane in a watertight condition. Only leaks or other membrane deficiencies that result from manufacturing defects are covered by this warranty. CertainTeed and/or its designated roofing contractor will repair, at CertainTeed's expense, such leaks or other membrane deficiencies covered by the warranty as necessary to retain the roof membrane in a watertight condition. CertainTeed is not responsible for any costs related to the removal or abatement of any asbestos present in any existing roofing system to which the CertainTeed roofing membrane is applied. The roof membrane referred to herein shall include the following components: a base sheet and a cap sheet applied per CertainTeed published specifications. The roof components which are not part of the roof membrane and hence NOT covered by this warranty are the following: underlying roof deck, insulation, vapor retarders, fasteners, metal work, drains, skylights, vents, plastic accessories, any flashing, decorative or reflective coating, surfacing and/or any ballast, rock or gravel.

Beyond SureStart™ Protection

Should any shingles prove to be defective subsequent to the SureStart™ period, CertainTeed's maximum contribution toward the cost of repairing or replacing the defective shingles will be calculated using the figure indicated in Table 1 as the maximum material liability, exclusive of costs of labor, roof tear-off and disposal, and by then decreasing that amount by the specified reduction figure for each month as measured from the date the shingles were installed to the date when proven defective.

Transferability

DURING THE SURESTART PERIOD

This limited warranty may be transferred by the original property owner/consumer to the first subsequent property owner. If the warranty is transferred by the original property owner/consumer during the SureStart period, the duration of the warranty, measured from the date of installation, will remain the same as for the original property owner/consumer, and the remaining period of SureStart protection will be available to the subsequent property owner.

With respect to Grand Manor Shingle, Centennial Slate, Carriage House Shingle, Presidential Shake TL and Landmark TL, if this warranty is effectively transferred during the ten (10) year SureStart period, the duration of the warranty will be 50 years measured from the date of installation, and the remaining period of SureStart protection will be available to the subsequent property owner.

AFTER THE SURESTART PERIOD

In the event that the warranty is transferred by the original property owner/consumer subsequent to the SureStart period, the warranty duration following the transfer will be two years from the date of real estate title transfer, and the warranty obligation will be calculated as explained in the above section titled "Beyond SureStart Protection."

Limitations

This warranty does not provide protection against any failure, defect or damage caused by situations and events beyond normal exposure conditions, including but not limited to:

- winds, including gusts, greater than those listed in Table 1 for each product, lightning, hurricane (see Limited Wind Warranty for hurricane wind exception), tornado, hailstorm, earthquake, fire, explosion, flood or falling objects.
- distortion, cracking or other failure, or movement of the base material over which the shingles are applied, or of the roof deck, or of the walls or foundation of the building itself.
- damage caused by structural changes, alterations or additions, or by the installation of equipment (such as aerials, signs or air-conditioning equipment) to the structure after the original shingles have been applied.
- stains or contamination to the shingle arising from sources such as, but not limited to, moss, lichens or other vegetation, mold or mildew growth, or paints, chemicals or other similar materials, unless the applied asphalt shingle was sold as an "algae-resistant shingle," in which case CertainTeed will clean, repair or replace, at its option, per the terms of the warranty, only such shingles which are proven to be contaminated with algae during the term of the warranty against algae growth.
- misuse, abuse or improper handling or storage of CertainTeed shingles.
- installation of shingles over non-approved roof decks as fully explained in the CertainTeed *Shingle Applicator's Manual*.
- damage to CertainTeed shingles, the roof deck or the structure caused by ice backup or ice damming.
- improper application or application not in accordance with CertainTeed's current written installation instructions.

Mold and mildew are functions of environmental conditions and are not manufacturing defects. As such, mold and mildew are not covered by this warranty or any implied warranty.

CertainTeed reserves the right to discontinue or modify any of its products, including the color of the shingles, and shall not be liable as a result of such discontinuance or modification, nor shall CertainTeed be liable in the event replacement material varies in color in comparison to the original product as a result of normal weathering. If CertainTeed replaces any material under this warranty, it may substitute products designated by CertainTeed to be of comparable quality or price range in the event the product initially installed has been discontinued or modified.

WARNING: FOR LOW-VOLUME RAIN AND SALT-FOG AREAS

In areas of low-volume rain (defined as insignificant rainfall during a 90-day period) and "salt fog," such as parts of the Southern California coastline, copper released by algae-resistant (AR) granules can react with the aluminum in gutters, leading to severe corrosion of the gutters. Therefore, in such regions, it is strongly recommended that aluminum gutters not be used with algae-resistant shingles. Vinyl or copper gutters are recommended.

CertainTeed disclaims all liability and responsibility for any damages that may be incurred by the use of its algae-resistant shingle products containing copper granules where aluminum gutters are used.

CertainTeed shall not have any liability or responsibility under its warranty for a) Damage to or defects in its shingles caused by settlement, movement, distortion, deterioration, cracking, or other failure of the roof deck or of the materials used as a roofing base over which its shingles are applied, b) Damage caused by the growth of mold or mildew, or c) Defects, damage, or failure caused by application of its shingles not in strict adherence with CertainTeed's written instructions.

In any instance in which the shingles qualify for only a 10-year warranty, CertainTeed's obligation will be calculated by using both the maximum material liability and applicable monthly reduction figure shown in Table 1 related to shingles applied to an inadequately ventilated roof deck.

Please refer to next page for remainder of warranty, including other conditions.

Inadequately Ventilated and Non-Ventilated Decks

Any shingles applied to inadequately ventilated or non-ventilated decks, other than the shingles and deck systems described in the paragraph below, titled "Insulated Decks and Radiant Barriers," shall qualify for a reduced warranty duration of 10 years with no SureStart coverage, with respect to shingle problems related to the absence of adequate roof system ventilation (see warranty for details).

Insulated Decks and Radiant Barriers

CertainTeed's Limited Asphalt Shingle Warranty, including SureStart™ coverage, will remain in force when its fiber glass asphalt shingles manufactured to meet ASTM D3462 are applied to roof deck assemblies (slopes \geq 2:12) where foam insulation is prefabricated into the roof deck system (often called "nailboard insulation"), where insulation is installed beneath an acceptable roof deck system, or where radiant barriers are installed, with or without ventilation directly below the deck. Acceptable roof deck surfaces must consist of either minimum $\frac{3}{8}$ " thick plywood or minimum $\frac{7}{16}$ " thick OSB. If an alternate deck surface material is being considered, contact CertainTeed Technical Services. **See the following important restrictions.**

The design professional is responsible for ensuring 1) proper quality and application of the insulation and/or radiant barrier, 2) provision of adequate structural ventilation and/or vapor retarders as determined to be necessary, and 3) that all local codes are met (particularly taking into account local climate conditions). Special attention must be taken if cellular foam, fiber glass, or cellulose insulations, or other highly-permeable insulation will be used in an unventilated system, or if the insulation/rafter or insulation/joist planes may create an air leak that could lead to moisture transmission and condensation problems. *All these important factors and decisions, while **not** the responsibility of CertainTeed Corporation, are critical to assure proper deck system performance.*

Ventilated Nail-Base Roof Insulation

Ventilated Nail-Base Roof Insulation products consist of rigid insulation (typically foam board) and some sort of material to provide air space above the insulation and below a nailable deck (which is typically minimum $\frac{7}{16}$ " thick OSB or minimum $\frac{3}{8}$ " plywood). These products can be a satisfactory way to provide soffit-to-ridge ventilation over cathedral-type ceilings, and their proper use will allow CertainTeed's Limited Asphalt Shingle Warranty to be unreduced. It is important to follow the deck manufacturer's instructions and ensure that sufficient ventilation is achieved. CertainTeed offers FlintBoard™ CV — cross-ventilating insulation boards with 1", 1 $\frac{1}{2}$ " and 2" air channels.

Limited Wind Warranty

CertainTeed warrants both its fiber glass asphalt shingles and its organic-base asphalt shingles to resist blow-off damage due to wind velocities, including gusts, and including hurricane winds where applicable (over 75 mph) during the first ten (10) years following application for Grand Manor Shingle, Centennial Slate, Carriage House Shingle, Presidential Shake TL, Landmark TL, Presidential Shake and Hatteras shingles. All other shingle products are warranted to resist blow-off damage due to wind velocities, including gusts, up to the maximum wind velocity per product listed in Table 1 (including hurricane winds where applicable) during the first five (5) year period following application of the shingles.

If any such blow-off damage does occur during those initial time periods after application, CertainTeed will furnish replacement shingles without charge for those shingles damaged (but will not be responsible for labor costs pertaining to removal or replacement of damaged shingles). If the applied shingles contain self-sealing asphalt strips, and if any of these strips fail to activate within the first year following application, CertainTeed shall have no liability under this warranty for such a defect unless CertainTeed is afforded the opportunity to hand-seal, at its expense, any non-sealing shingles.

Any costs in excess of CertainTeed's contribution shall be the owner's responsibility through homeowner's insurance, etc.

What the Customer Must Do

The property owner must promptly notify CertainTeed in writing of any manufacturing defect or algae contamination and provide proof of the date of purchase and date of application of the shingles. CertainTeed will then investigate the claim, and if a defect covered by this warranty is confirmed, CertainTeed, within a reasonable amount of time after inspecting the shingle, will repair, replace or clean the defective shingles or reimburse the property owner the appropriate amount for the repair, replacement or cleaning of the shingles under the terms of the warranty.

All notifications should be sent to: CertainTeed, 1400 Union Meeting Road, Blue Bell, PA 19422
Attn: RPG Technical Services Department,
Telephone number: 800-345-1145

Warranty Registration (not required)

CertainTeed would like to offer you a way to safeguard your investment by registering your product warranty on the CertainTeed Website at www.certainteed.com/warranty. You will then receive a numbered registration confirmation by return e-mail that can be printed out and kept with this warranty document and your proof of purchase. Failure to register this warranty shall NOT void the warranty or any of its terms. **For those without internet access please feel free to provide us with your complete name, address and phone number; the name and contact information for your roofing contractor and the name of the shingle, number of squares, color and installation date.** We will register the information for you and mail you the confirmation.

**Mail to CertainTeed Corporation, Roofing Products Group
P.O. Box 860, Valley Forge, PA 19482.**

Please refer to back page for remainder of warranty, including other conditions.

WHAT IS A SELF-SEALING STRIP?

Most shingles contain a factory applied self-sealing asphalt strip which must be subjected to direct sunlight for several days before sealing will occur. Shingles installed in the fall or winter may not seal until the following spring. Shingles which do not receive direct sunlight or which are not exposed to adequate surface temperatures may never seal and must be hand sealed at time of application. Improper installation of shingles, or damage to the factory applied self-sealing strip by dust, sand, or foreign matter, will prevent the sealing strip from activating. Failure of the shingles to seal under any of the above circumstances is **not** a manufacturing defect and CertainTeed will not be responsible for repairing, replacing or hand-sealing any shingles under any such circumstance.

WHAT IS A “SHANGLE®”?

The “Shangle®,” an idea conceived by CertainTeed over 35 years ago, is the original “laminated shingle.” The Shangle features a full-size, one-piece shingle as a base, to which individual shingle tabs or overlay pads are applied, providing extra protection and aesthetic enhancement to the roof.

A *Super Shangle®* takes this idea one step further by using it on an 18" x 36" base layer, adding another shingle layer and the shingle tabs.

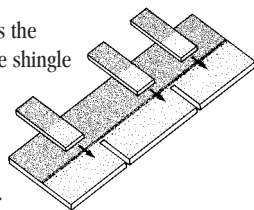

WHAT IS A TRI-LAMINATE™?

Our patented Tri-Laminate™ process combines three layers of the industry's most durable materials into an exceptionally strong, dramatically thick roofing product styled with the classic appeal of wood shakes. The stunning, 3-dimensional appearance of CertainTeed's Super Shake™ products gives your roof tremendous depth and distinction beyond comparison.

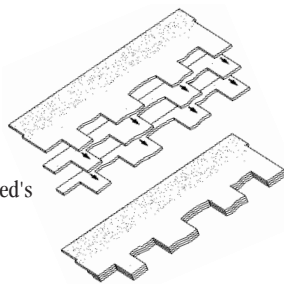

WHAT IS A TWO-PIECE LAMINATE?

Whereas a Shangle consists of a full-size, one-piece base shingle onto which tabs or pads are applied, a two-piece laminate uses a full-size shingle with tab-size teeth cut out of it. Adhered to the back of this top shingle is a half shingle that runs behind the cutouts. The result is a multi-layered shingle that provides a rugged, textured look on the roof.

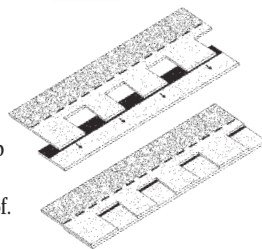

WHAT IS AN ALGAE-RESISTANT SHINGLE?

Many of CertainTeed's fiber glass shingles are available in an algae-resistant version. Commonly, although incorrectly, called “fungus,” the black and green algae that creates unsightly streaking on shingles is a common occurrence in warm, humid climates. CertainTeed AR shingles carry an exceptional 10- or 15-year limited warranty against algae contamination.

FOR YOUR RECORDS ONLY:

Product Purchased _____ Date of Installation _____

Roofing Contractor _____ Contractor's Phone No. _____

This warranty, which is effective on shingles applied on or after January 1, 2005, supersedes the written warranty previously issued by CertainTeed coded No. 20-20-1890.

THIS WARRANTY REPLACES ALL OTHER ORAL OR WRITTEN WARRANTIES, LIABILITIES OR OBLIGATIONS OF CERTAINTEED. APPLICABLE STATE LAW WILL DETERMINE THE PERIOD OF TIME FOLLOWING THE SALE THAT A PROPERTY OWNER/CONSUMER MAY SEEK A REMEDY UNDER THE IMPLIED WARRANTY OF MERCHANTABILITY OR FITNESS FOR A PARTICULAR PURPOSE. IN NO EVENT SHALL CERTAINTEED BE LIABLE FOR CONSEQUENTIAL OR INCIDENTAL DAMAGES OF ANY KIND, INCLUDING ANY DAMAGE TO THE BUILDING, ITS CONTENTS OR ANY PERSONS THEREIN, RESULTING FROM THE BREACH OF THIS WARRANTY. NO FIELD REPRESENTATIVE, DISTRIBUTOR OR DEALER OF CERTAINTEED IS AUTHORIZED TO CHANGE OR MODIFY THIS WARRANTY. SOME STATES DO NOT ALLOW THE EXCLUSION OR LIMITATION OF INCIDENTAL OR CONSEQUENTIAL DAMAGES, SO THE ABOVE EXCLUSIONS MAY NOT APPLY TO YOU.

This warranty gives you specific legal rights, and you may also have other rights that vary from state to state.

ROOFING PLANTS AND REGIONAL SALES OFFICES

CertainTeed roofing products are sold by the Roofing Products Group of CertainTeed Corporation in seven sales regions. They are manufactured in eleven residential roofing plants and two commercial roofing plants.

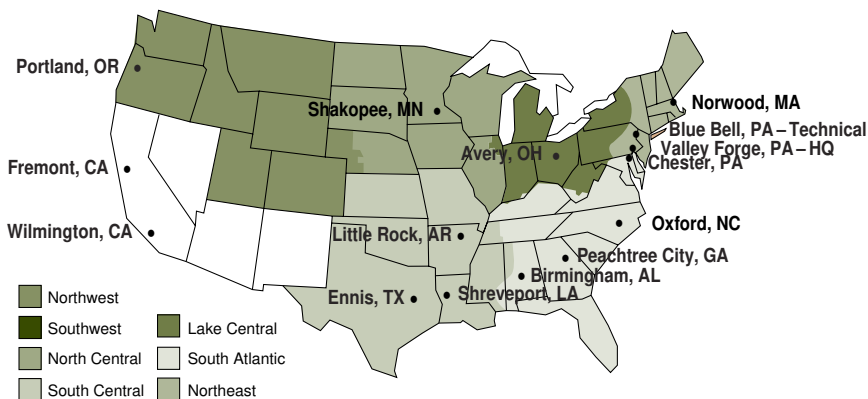

Since the early 1900s, CertainTeed Corporation has been an innovator in the building materials industry and today is a leading manufacturer of building materials including residential and commercial roofing, vinyl and fiber cement siding, vinyl windows, composite decking and railing, fiber glass insulation, vinyl fence, and piping products. The company is headquartered in Valley Forge, Pennsylvania, and employs more than 7,000 employees at approximately 50 manufacturing facilities throughout North America. Continuing the 100-year commitment of “quality made *certain*, satisfaction guaranteed,” CertainTeed remains one of the most trusted names in the industry. More information is available at www.certainteed.com.

CertainTeed Corporation
Roofing Products Group
P.O. Box 860 • Valley Forge, PA 19482
800-345-1145

CertainTeed 
Quality made certain. Satisfaction guaranteed.

© 2005 CertainTeed Corporation 20-20-1927

CertainTeed

2006 Limited Warranty

Asphalt Shingle Products



CertainTeed 

Quality made certain. Satisfaction guaranteed.™

CONGRATULATIONS!

... and thank you for your recent purchase of one of the fine products in the CertainTeed Roofing Collection™. Since 1904, CertainTeed has been producing quality roofing products that provide long-lasting beauty and protection for homes of every size, style and age. For the past 100 years, the basis for our name, “Quality made *certain*, satisfaction guaranteed,” has been our ongoing philosophy.



Celebrating a Century of Building America

Your CertainTeed roofing warranty fully explains how CertainTeed supports its products with the strongest warranty protection available. It is important that you read the warranty section of this brochure. The warranty lists the specific CertainTeed asphalt shingle products that are covered and the period of time for which they are covered. Take the time to understand how CertainTeed protects your purchase by standing behind our products.

SURESTART™ PROTECTION

Because CertainTeed roofing products are manufactured to the highest quality standards, we confidently include the additional assurance of SureStart™ protection with all CertainTeed shingles. SureStart provides the strongest protection you can get in the vital early years after your new roof has been applied.

Simply put, if a manufacturing defect is discovered during the SureStart period, CertainTeed will provide reimbursement of 100% of the cost of the shingles and labor to repair the defective shingles or apply new shingles to replace the defective shingles (exclusive of costs of tear-off, metal work and disposal). SureStart protection is not prorated or otherwise reduced over time.

SureStart protection does not extend to any shingles applied to any non-ventilated or inadequately ventilated roof deck systems, except as stated on page 6.

TRANSFERABILITY

The warranty for CertainTeed shingles is transferable by the original property owner/consumer to the first subsequent owner. Upon transfer of the warranty during the product's SureStart period, the remaining duration of the warranty for the new owner is the same as it would have been for the original owner, except for lifetime products where the duration of the warranty will be 50 years measured from date of installation.

The remaining period of SureStart protection will be available to the first subsequent property owner.

For product warranties transferred after the SureStart period has elapsed, the remaining duration of the transferred warranty will be limited to **two** years from the date of real estate title transfer.

(See page 5 – Transferability – for further details)

LIMITED WARRANTY

This warranty covers asphalt shingle products sold only in the United States of America, its territories and Canada.

What and Who Is Covered and for How Long

CertainTeed warrants to the original property owner/consumer that its asphalt roofing shingles will be free from manufacturing defects for the length of time specified in Table 1, and that CertainTeed will repair or replace, at its option, any shingles proven to be defective under the terms of this warranty.

In addition, CertainTeed warrants that the Algae-Resistant versions of Grand Manor Shingle®, Centennial Slate™, Carriage House Shingle™, Presidential Shake™ TL Ultimate, Landmark™ TL Ultimate, Landmark™ TL Ultimate (Impact Resistant) and Presidential Shake™ AR will remain free from algae growth (but **not** mold or mildew growth), which adversely affects the overall appearance of said shingles for a period of fifteen (15) years, and that Independence Shingle® AR, Hatteras®, Landmark™ Premium, Woodscape® Premium, Landmark™ Plus, Landmark™ Special, Landmark™, Woodscape®, Classic Horizon Shingle® AR, XT™ 30 AR, XT™ 30 IR, Patriot™ AR, XT™ 25 AR/Seal King® 25 AR and CT20 AR shingles that were sold as “algae-resistant shingles” will remain free from algae growth (but **not** mold or mildew growth) which adversely affects the overall appearance of said shingles for a period of ten (10) years. However, CertainTeed reserves the right to clean the algae stains from the shingles rather than repair or replace the contaminated shingles.

In the event of repair, replacement or cleaning pursuant to the terms of this warranty, the original warranty shall apply to the replacement shingles or the repaired or cleaned shingles and will extend for the balance of the warranty period in effect at the time the shingles proved defective.

The lifetime coverage for Grand Manor Shingle, Centennial Slate, Carriage House Shingle, Presidential Shake TL Ultimate, Landmark TL Ultimate, Landmark TL Ultimate (Impact Resistant), Presidential Shake, Landmark Premium, Woodscape Premium and Independence offered by this warranty is designed to cover individual homeowners only. In the instance of shingles purchased by or installed upon property owned by, for example, corporations, governmental agencies, partnerships, trusts, religious organizations, schools, condominiums or cooperative housing arrangements, or installed on apartment buildings or any other type of building or premises not used by individual homeowners as their residence, the warranty period for Grand Manor Shingle, Centennial Slate, Carriage House Shingle, Presidential Shake TL Ultimate, Landmark TL Ultimate, Landmark TL Ultimate (Impact Resistant), Presidential Shake, Landmark Premium, Woodscape Premium and Independence will be 50 years following the installation of the shingles. Further, CertainTeed’s maximum liability after the SureStart period will be calculated using the figure indicated in Table 1 as the maximum material liability, exclusive of costs of labor, roof tear-off, metal work, and disposal, and by then decreasing that amount by the reduction figure specified in Table 1 for each month as measured from the date the shingles were installed to the date when proven defective.

SureStart™ Protection

All of CertainTeed’s shingle products are covered by SureStart™ protection for the period specified in Table 1. Under this warranty feature, CertainTeed, at no charge, will repair or replace, at its option, any shingles proven to be defective during the applicable SureStart period (the SureStart period begins when shingle application has been completed and terminates at the end of the year indicated as its term of duration; i.e., the SureStart period for Independence Shingle terminates at the completion of its fifth year of service). CertainTeed’s maximum material liability under SureStart will be equal to the reasonable cost to replace the defective shingles, plus labor. CertainTeed shall not be responsible or liable for costs of roof tear-off and disposal and of flashing and metal work (and repairs required by defects therein) except for Grand Manor Shingle, Centennial Slate, Carriage House Shingle, Presidential Shake TL Ultimate, Landmark TL Ultimate, Landmark TL Ultimate (Impact Resistant), and Presidential Shake for which CertainTeed’s maximum liability will also include the cost of roof tear-off and disposal.

SureStart protection does not extend to any shingles applied to any non-ventilated or inadequately ventilated roof deck systems, except as stated on page 6. In the case of these shingles, CertainTeed’s maximum contribution toward the cost of repairing, replacing or cleaning the defective shingles will be calculated using the figure indicated in Table 1 as the maximum material liability, exclusive of costs of labor, roof tear-off and disposal, and by then decreasing that amount by the reduction figure (related to shingles applied to an inadequately ventilated roof deck) for each month as measured from the date the shingles were installed to the date when proven defective.

In instances in which CertainTeed, under the terms of this warranty, has agreed to pay the cost of labor required to repair, replace or clean defective or contaminated shingles, CertainTeed will provide reimbursement only upon receipt of a copy of the contractor’s invoice or other written evidence of the completion of such work which CertainTeed, in its sole discretion, deems acceptable.

Please refer to next page for remainder of warranty, including other conditions.

TABLE I

Product	Warranty Period	SureStart™ Period	Wind Warranty MPH	Algae Resistant Warranty Period**	Maximum Material Liability After SureStart Period	Reduction Figure Per Month
GRAND MANOR SHANGLE®	LIFETIME	10 YEARS	110	15	\$140/Square	1/600*
CENTENNIAL SLATE™	LIFETIME	10 YEARS	110	15	\$130/Square	1/600*
CARRIAGE HOUSE SHANGLE™	LIFETIME	10 YEARS	110	15	\$110/Square	1/600*
PRESIDENTIAL SHAKE™ TL ULTIMATE (& AR)	LIFETIME	10 YEARS	110	15	\$140 Square	1/600*
LANDMARK™ TL ULTIMATE (& AR) (& IMPACT RESISTANT)	LIFETIME	10 YEARS	110	15	\$120/Square	1/600*
PRESIDENTIAL SHAKE™ (& AR)	LIFETIME	10 YEARS	110	15	\$95/Square	1/600*
LANDMARK™ PREMIUM (& AR)	LIFETIME	10 YEARS	90††	10	\$55/Square	1/600*
WOODSCAPE® PREMIUM	LIFETIME	10 YEARS	90††	10	\$55/Square	1/600*
INDEPENDENCE SHANGLE® (& AR)	LIFETIME	5 YEARS	110	10	\$55/Square	1/600*
LANDMARK™ SPECIAL	50 YEARS	5 YEARS	110	10	\$55/Square	1/600
HATTERAS®	40 YEARS	5 YEARS	110	10	\$55/Square	1/480
LANDMARK™ PLUS (& AR)	40 YEARS	5 YEARS	80††	10	\$45/Square	1/480
HALLMARK SHANGLE®	40 YEARS	5 YEARS	80	N/A	\$55/Square	1/480
XT™ 30 (& AR) (& IMPACT RESISTANT)	30 YEARS	5 YEARS	70†††	10	\$35/Square	1/360
LANDMARK™ (& AR)	30 YEARS	5 YEARS	70††	10	\$40/Square	1/360
WOODSCAPE® AR	30 YEARS	5 YEARS	70††	10	\$40/Square	1/360
PATRIOT™	30 YEARS	5 YEARS	70	10	\$40/Square	1/360
CLASSIC HORIZON SHANGLE® (& AR)	30 YEARS	5 YEARS	70	10	\$40/Square	1/360
NEW HORIZON SHANGLE®	30 YEARS	5 YEARS	70	N/A	\$40/Square	1/360
XT™ 25 (& AR)/SEAL KING® 25 (& AR)	25 YEARS	5 YEARS	60	10	\$30/Square	1/300
JET™ 25	25 YEARS	4 YEARS	60	N/A	\$30/Square	1/300
CT 20 (& AR)	20 YEARS	3 YEARS	60	10	\$25/Square	1/240
ANY SHINGLES APPLIED TO ANY INADEQUATELY VENTILATED ROOF DECK	10 YEARS†	N/A	N/A	N/A	See Above	1/120

* For Grand Manor Shangle, Centennial Slate, Carriage House Shangle, Presidential Shake TL Ultimate, Landmark TL Ultimate, Landmark TL Ultimate (Impact Resistant), Presidential Shake, Landmark Premium, Woodscape Premium and Independence at the completion of the 40th year the reduction figure will remain at 480/600, or 20% of the total maximum liability.

** Algae Resistant Warranty period cited is only applicable to Algae Resistant version of the pertinent shingle.

† For details of warranty coverage for shingles installed on inadequately ventilated roof decks on both residential and commercial buildings, see provisions on page 6 under “Inadequately Ventilated and Non-Ventilated Decks.”

†† Laminate wind warranty upgrade. Roof shingles shall be resistant to blow-off due to wind velocities, including gusts, up to a maximum of 110 miles per hour for Landmark Premium and Woodscape Premium during the first ten (10) year and 90 mph for Landmark Plus and 80 mph for Landmark and Woodscape, during the first five (5) years following application, provided that the shingles are installed using six (6) nails, in the common bond area, per shingle.

CertainTeed warrants that Landmark TL Ultimate (Impact Resistant), Landmark Special and XT30 IR are compliant with UL 2218 Impact Resistance of Prepared Roof Covering Materials test criteria at time of manufacture.

††† Wind warranty for XT30 (& AR) (& Impact Resistant) for the Northwest region is 80 mph.

Flintlastic™ SA (Self-Adhering) System

For small low slope residential roofing projects – less than 20 squares (such as decks, additions and porches) – CertainTeed offers the following 12-year SureStart membrane warranty on our two-ply system consisting of Flintlastic™ SA Nail Base and Flintlastic SA Cap sheet, providing the system has been applied in accordance with CertainTeed’s current written installation instructions.

CertainTeed warrants the roof membrane for a period of 12 years from the date of completion of the roof membrane installation. During the duration of this warranty, CertainTeed will repair the roof membrane as necessary to retain the membrane in a watertight condition. Only leaks or other membrane deficiencies that result from manufacturing defects are covered by this warranty. CertainTeed and/or its designated roofing contractor will repair, at CertainTeed’s expense, such leaks or other membrane deficiencies covered by the warranty as necessary to retain the roof membrane in a watertight condition. CertainTeed is not responsible for any costs related to the removal or abatement of any asbestos present in any existing roofing system to which the CertainTeed roofing membrane is applied. The roof membrane referred to herein shall include the following components: a base sheet and a cap sheet applied per CertainTeed

published specifications. The roof components which are not part of the roof membrane and hence NOT covered by this warranty are the following: underlying roof deck, insulation, vapor retarders, fasteners, metal work, drains, skylights, vents, plastic accessories, any flashing, decorative or reflective coating, surfacing and/or any ballast, rock or gravel.

Beyond SureStart™ Protection

Should any shingles prove to be defective subsequent to the SureStart™ period, CertainTeed's maximum contribution toward the cost of repairing or replacing the defective shingles will be calculated using the figure indicated in Table 1 as the maximum material liability, exclusive of costs of labor, roof tear-off and disposal, and by then decreasing that amount by the specified reduction figure for each month as measured from the date the shingles were installed to the date when proven defective.

Transferability

DURING THE SURESTART PERIOD

This limited warranty is transferable by the original property owner/consumer to the first subsequent property owner provided that the first subsequent property owner gives written notice to CertainTeed within 60 days from the date of real estate title transfer. (Notice should be sent to RPG Technical Services Department, 1400 Union Meeting Road, Blue Bell, PA 19422.)

With respect to Grand Manor Shingle, Centennial Slate, Carriage House Shingle, Presidential Shake TL Ultimate, Landmark TL Ultimate, Landmark TL Ultimate (Impact Resistant), Landscape Premium, Woodscape Premium and Presidential Shake if this warranty is effectively transferred as described in the paragraph above during the ten (10) year SureStart period, the duration of the warranty will be 50 years measured from the date of installation, and the remaining period of SureStart protection will be available to the subsequent property owner.

AFTER THE SURESTART PERIOD

In the event that the warranty is transferred by the original property owner/consumer subsequent to the SureStart period, the warranty duration following the transfer will be two years from the date of real estate title transfer, and the warranty obligation will be calculated as explained in the above section titled "Beyond SureStart Protection."

Limitations

This warranty does not provide protection against any failure, defect or damage caused by situations and events beyond normal exposure conditions, including but not limited to:

- winds, including gusts, greater than those listed in Table 1 for each product, lightning, hurricane (see Limited Wind Warranty for hurricane wind exception), tornado, hailstorm, earthquake, fire, explosion, flood or falling objects.
- distortion, cracking or other failure, or movement of the base material over which the shingles are applied, or of the roof deck, or of the walls or foundation of the building itself.
- damage caused by structural changes, alterations or additions, or by the installation of equipment (such as aerials, signs or air-conditioning equipment) to the structure after the original shingles have been applied.
- stains or contamination to the shingle arising from sources such as, but not limited to, moss, lichens or other vegetation, mold or mildew growth, or paints, chemicals or other similar materials, unless the applied asphalt shingle was sold as an "algae-resistant shingle," in which case CertainTeed will clean, repair or replace, at its option, per the terms of the warranty, only such shingles which are proven to be contaminated with algae during the term of the warranty against algae growth.
- misuse, abuse or improper handling or storage of CertainTeed shingles.
- installation of shingles over non-approved roof decks as fully explained in the CertainTeed *Shingle Applicator's Manual*.
- damage to CertainTeed shingles, the roof deck or the structure caused by ice backup or ice damming.
- improper application or application not in accordance with CertainTeed's current written installation instructions.

Mold and mildew are functions of environmental conditions and are not manufacturing defects. As such, mold and mildew are not covered by this warranty or any implied warranty.

CertainTeed reserves the right to discontinue or modify any of its products, including the color of the shingles, and shall not be liable as a result of such discontinuance or modification, nor shall CertainTeed be liable in the event replacement material varies in color in comparison to the original product as a result of normal weathering. If CertainTeed replaces any material under this warranty, it may substitute products designated by CertainTeed to be of comparable quality or price range in the event the product initially installed has been discontinued or modified.

WARNING: FOR LOW-VOLUME RAIN AND SALT-FOG AREAS

In areas of low-volume rain (defined as insignificant rainfall during a 90-day period) and "salt fog," such as parts of the Southern California coastline, copper released by algae-resistant (AR) granules can react with the aluminum in gutters, leading to severe corrosion of the gutters. Therefore, in such regions, it is strongly recommended that aluminum gutters not be used with algae-resistant shingles. Vinyl or copper gutters are recommended.

CertainTeed disclaims all liability and responsibility for any damages that may be incurred by the use of its algae-resistant shingle products containing copper granules where aluminum gutters are used.

In any instance in which the shingles qualify for only a 10-year warranty, CertainTeed's obligation will be calculated by using both the maximum material liability and applicable monthly reduction figure shown in Table 1 related to shingles applied to an inadequately ventilated roof deck.

Inadequately Ventilated and Non-Ventilated Decks

Any shingles applied to inadequately ventilated or non-ventilated decks, other than the shingles and deck systems described in the paragraph below, titled "Insulated Decks and Radiant Barriers," shall qualify for a reduced warranty duration of 10 years with no SureStart coverage, with respect to shingle problems related to the absence of adequate roof system ventilation.

Insulated Decks and Radiant Barriers

CertainTeed's Limited Asphalt Shingle Warranty, including SureStart™ coverage, will remain in force when its fiber glass asphalt shingles manufactured to meet ASTM D3462 are applied to roof deck assemblies (slopes \geq 2:12) where foam insulation is prefabricated into the roof deck system (often called "nailboard insulation"), where insulation is installed beneath an acceptable roof deck system, or where radiant barriers are installed, with or without ventilation directly below the deck. Acceptable roof deck surfaces must consist of either minimum $\frac{3}{8}$ " thick plywood or minimum $\frac{7}{16}$ " thick OSB. If an alternate deck surface material is being considered, contact CertainTeed Technical Services. ***See the following important restrictions.***

The design professional is responsible for ensuring 1) proper quality and application of the insulation and/or radiant barrier, 2) provision of adequate structural ventilation and/or vapor retarders as determined to be necessary, and 3) that all local codes are met (particularly taking into account local climate conditions). Special attention must be taken if cellular foam, fiber glass, or cellulose insulations, or other highly-permeable insulation will be used in an unventilated system, or if the insulation/rafter or insulation/joist planes may create an air leak that could lead to moisture transmission and condensation problems. *All these important factors and decisions, while **not** the responsibility of CertainTeed Corporation, are critical to assure proper deck system performance.*

Ventilated Nail-Base Roof Insulation

Ventilated Nail-Base Roof Insulation products consist of rigid insulation (typically foam board) and some sort of material to provide air space above the insulation and below a nailable deck (which is typically minimum $\frac{7}{16}$ " thick OSB or minimum $\frac{3}{8}$ " plywood). These products can be a satisfactory way to provide soffit-to-ridge ventilation over cathedral-type ceilings, and their proper use will allow CertainTeed's Limited Asphalt Shingle Warranty to be unreduced. It is important to follow the deck manufacturer's instructions and ensure that sufficient ventilation is achieved. CertainTeed offers FlintBoard™ CV — cross-ventilating insulation boards with 1", 1 $\frac{1}{2}$ " and 2" air channels.

Limited Wind Warranty

CertainTeed warrants its fiber glass asphalt shingles to resist blow-off damage due to wind velocities, including gusts, and including hurricane winds where applicable (over 75 mph) during the first ten (10) years following application for Grand Manor Shingle, Centennial Slate, Carriage House Shingle, Presidential Shake TL Ultimate, Landmark TL Ultimate, Landmark TL Ultimate (Impact Resistant), Presidential Shake, Landmark Premium, Woodscape Premium and Hatteras shingles. All other shingle products are warranted to resist blow-off damage due to wind velocities, including gusts, up to the maximum wind velocity per product listed in Table 1 (including hurricane winds where applicable) during the first five (5) year period following application of the shingles.

If any such blow-off damage does occur during those initial time periods after application, CertainTeed will furnish replacement shingles without charge for those shingles damaged (but will not be responsible for labor costs pertaining to removal or replacement of damaged shingles). If the applied shingles contain self-sealing asphalt strips, and if any of these strips fail to activate within the first year following application, CertainTeed shall have no liability under this warranty for such a defect unless CertainTeed is afforded the opportunity to hand-seal, at its expense, any non-sealing shingles.

Any costs in excess of CertainTeed's contribution shall be the owner's responsibility through homeowner's insurance, etc.

What the Customer Must Do

The property owner must promptly notify CertainTeed in writing of any manufacturing defect or algae contamination and provide proof of the date of purchase and date of application of the shingles. CertainTeed will then investigate the claim, and if a defect covered by this warranty is confirmed, CertainTeed, within a reasonable amount of time after inspecting the shingle, will repair, replace or clean the defective shingles or reimburse the property owner the appropriate amount for the repair, replacement or cleaning of the shingles under the terms of the warranty.

All notifications should be sent to: CertainTeed, 1400 Union Meeting Road, Blue Bell, PA 19422

Attn: RPG Technical Services Department, Telephone number: 800-345-1145

Warranty Registration (not required)

CertainTeed would like to offer you a way to safeguard your investment by registering your product warranty on the CertainTeed Website at www.certainteed.com/warranty. You will then receive a numbered registration confirmation by return e-mail that can be printed out and kept with this warranty document and your proof of purchase. Failure to register this warranty shall NOT void the warranty or any of its terms. **For those without internet access please feel free to provide us with your complete name, address and phone number; the name and contact information for your roofing contractor and the name of the shingle, number of squares, color and installation date.** We will register the information for you and mail you the confirmation.

**Mail to CertainTeed Corporation, Roofing Products Group
P.O. Box 860, Valley Forge, PA 19482.**

Please refer to back page for remainder of warranty, including other conditions.

WHAT IS A SELF-SEALING STRIP?

Most shingles contain a factory applied self-sealing asphalt strip which must be subjected to direct sunlight for several days before sealing will occur. Shingles installed in the fall or winter may not seal until the following spring. Shingles which do not receive direct sunlight or which are not exposed to adequate surface temperatures may never seal and must be hand sealed at time of application. Improper installation of shingles, or damage to the factory applied self-sealing strip by dust, sand, or foreign matter, will prevent the sealing strip from activating. Failure of the shingles to seal under any of the above circumstances is **not** a manufacturing defect and CertainTeed will not be responsible for repairing, replacing or hand-sealing any shingles under any such circumstance.

WHAT IS A “SHANGLE® ”?

The “Shangle®,” an idea conceived by CertainTeed over 35 years ago, is the original “laminated shingle.” The Shangle features a full-size, one-piece shingle as a base, to which individual shingle tabs or overlay pads are applied, providing extra protection and aesthetic enhancement to the roof.

A *Super Shangle®* takes this idea one step further by using it on an 18" x 36" base layer, adding another shingle layer and the shingle tabs.

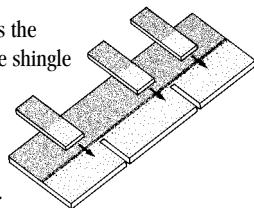

WHAT IS A TRI-LAMINATE™?

Our patented Tri-Laminate™ process combines three layers of the industry’s most durable materials into an exceptionally strong, dramatically thick roofing product styled with the classic appeal of wood shakes. The stunning, 3-dimensional appearance of CertainTeed’s Super Shake™ products gives your roof tremendous depth and distinction beyond comparison.

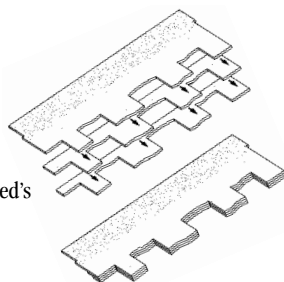

WHAT IS A TWO-PIECE LAMINATE?

Whereas a Shangle consists of a full-size, one-piece base shingle onto which tabs or pads are applied, a two-piece laminate uses a full-size shingle with tab-size teeth cut out of it. Adhered to the back of this top shingle is a half shingle that runs behind the cutouts. The result is a multi-layered shingle that provides a rugged, textured look on the roof.

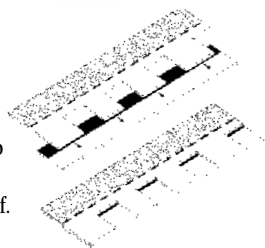

WHAT IS AN ALGAE-RESISTANT SHINGLE?

Many of CertainTeed’s fiber glass shingles are available in an algae-resistant version. Commonly, although incorrectly, called “fungus,” the black and green algae that creates unsightly streaking on shingles is a common occurrence in warm, humid climates. CertainTeed AR shingles carry an exceptional 10- or 15-year limited warranty against algae contamination.

FOR YOUR RECORDS ONLY:

Product Purchased _____ Date of Installation _____

Roofing Contractor _____ Contractor's Phone No. _____

This warranty, which is effective on shingles applied on or after January 1, 2006, supersedes the written warranty previously issued by CertainTeed coded No. 20-20-1927.

THIS WARRANTY REPLACES ALL OTHER ORAL OR WRITTEN WARRANTIES, LIABILITIES OR OBLIGATIONS OF CERTAINTEED. APPLICABLE STATE LAW WILL DETERMINE THE PERIOD OF TIME FOLLOWING THE SALE THAT A PROPERTY OWNER/CONSUMER MAY SEEK A REMEDY UNDER THE IMPLIED WARRANTY OF MERCHANTABILITY OR FITNESS FOR A PARTICULAR PURPOSE. IN NO EVENT SHALL CERTAINTEED BE LIABLE FOR CONSEQUENTIAL OR INCIDENTAL DAMAGES OF ANY KIND, INCLUDING ANY DAMAGE TO THE BUILDING, ITS CONTENTS OR ANY PERSONS THEREIN, RESULTING FROM THE BREACH OF THIS WARRANTY. NO FIELD REPRESENTATIVE, DISTRIBUTOR OR DEALER OF CERTAINTEED IS AUTHORIZED TO CHANGE OR MODIFY THIS WARRANTY. SOME STATES DO NOT ALLOW THE EXCLUSION OR LIMITATION OF INCIDENTAL OR CONSEQUENTIAL DAMAGES, SO THE ABOVE EXCLUSIONS MAY NOT APPLY TO YOU.

This warranty gives you specific legal rights, and you may also have other rights that vary from state to state.

ROOFING PLANTS AND REGIONAL SALES OFFICES

CertainTeed roofing products are sold by the Roofing Products Group of CertainTeed Corporation in eight sales regions. They are manufactured in eleven residential roofing plants and two commercial roofing plants.



Since the early 1900s, CertainTeed Corporation has been an innovator in the building materials industry and today is a leading manufacturer of building materials including residential and commercial roofing, vinyl and fiber cement siding, vinyl windows, composite decking and railing, fiber glass insulation, vinyl fence, and piping products. The company is headquartered in Valley Forge, Pennsylvania, and employs more than 7,000 employees at approximately 50 manufacturing facilities throughout North America. Continuing the 100-year commitment of "quality made *certain*, satisfaction guaranteed," CertainTeed remains one of the most trusted names in the industry. More information is available at www.certainteed.com.

This document is available in Spanish. Call 1-800-782-8777. (Note: The operators do not speak Spanish.)
Se puede obtener este documento en español. Favor de llamar 1-800-782-8777. (Los operadores no hablan español.)

CertainTeed Corporation Professional: 800-233-8990
P.O. Box 860 Consumer: 800-782-8777
Valley Forge, PA 19482 www.certainteed.com

20-20-1954 Rev. 2/06 ©2006 CertainTeed Corporation, Printed in U.S.A.



CertainTeed

2007 Limited Warranty

Asphalt Shingle Products



CertainTeed 

Quality made certain. Satisfaction guaranteed.™

CONGRATULATIONS!

... and thank you for your recent purchase of one of the fine products in the CertainTeed Roofing Collection™. Since 1904, CertainTeed has been producing quality roofing products that provide long-lasting beauty and protection for homes of every size, style and age. For the past 100 years, the basis for our name, “Quality made *certain*, satisfaction guaranteed,” has been our ongoing philosophy.



Celebrating a Century of Building America

Your CertainTeed roofing warranty fully explains how CertainTeed supports its products with the strongest warranty protection available. It is important that you read the warranty section of this brochure. The warranty lists the specific CertainTeed asphalt shingle products that are covered and the period of time for which they are covered. Take the time to understand how CertainTeed protects your purchase by standing behind our products.

SURESTART™ PROTECTION

Because CertainTeed roofing products are manufactured to the highest quality standards, we confidently include the additional assurance of SureStart™ protection with all CertainTeed shingles. SureStart provides the strongest protection you can get in the vital early years after your new roof has been applied.

Simply put, if a manufacturing defect is discovered during the SureStart period, CertainTeed will provide reimbursement of 100% of the cost of the shingles and labor to repair the defective shingles or apply new shingles to replace the defective shingles (exclusive of costs of tear-off, metal work and disposal). SureStart protection is not prorated or otherwise reduced over time.

SureStart protection does not extend to any shingles applied to any non-ventilated or inadequately ventilated roof deck systems, except as stated on page 6.

TRANSFERABILITY

The warranty for CertainTeed shingles is transferable by the original property owner/consumer to the first subsequent owner. Upon transfer of the warranty during the product's SureStart period, the remaining duration of the warranty for the new owner is the same as it would have been for the original owner, except for lifetime products where the duration of the warranty will be 50 years measured from date of installation.

The remaining period of SureStart protection will be available to the first subsequent property owner.

For product warranties transferred after the SureStart period has elapsed, the remaining duration of the transferred warranty will be limited to **two** years from the date of real estate title transfer.

(See page 5 – Transferability – for further details)

LIMITED WARRANTY

This warranty covers asphalt shingle products sold only in the United States of America, its territories and Canada.

What and Who Is Covered and for How Long

CertainTeed warrants to the original property owner/consumer that its asphalt roofing shingles will be free from manufacturing defects for the length of time specified in Table 1, and that CertainTeed will repair or replace, at its option, any shingles proven to be defective under the terms of this warranty.

In addition, CertainTeed warrants that the Algae-Resistant versions of Grand Manor Shingle®, Centennial Slate™, Carriage House Shingle™, Presidential Shake™ TL Ultimate, Landmark™ TL Ultimate, Landmark™ TL Ultimate (Impact Resistant) Presidential Shake™ and Presidential Shake™ (Impact Resistant) will remain free from algae growth (but **not** mold or mildew growth), which adversely affects the overall appearance of said shingles for a period of fifteen (15) years, and that Independence Shingle®, Hatteras®, Landmark™ Premium, Woodscape® Premium, Landmark™ Plus, Landmark™ Special, Landmark™, Woodscape®, Classic Horizon Shingle®, XT™ 30, XT™30 (Impact Resistant), Patriot™, XT™25/Seal King®25 and CT20 shingles that were sold as “algae-resistant shingles” will remain free from algae growth (but **not** mold or mildew growth) which adversely affects the overall appearance of said shingles for a period of ten (10) years. However, CertainTeed reserves the right to clean the algae stains from the shingles rather than repair or replace the contaminated shingles.

In the event of repair, replacement or cleaning pursuant to the terms of this warranty, the original warranty shall apply to the replacement shingles or the repaired or cleaned shingles and will extend for the balance of the warranty period in effect at the time the shingles proved defective.

The lifetime coverage for Grand Manor Shingle, Centennial Slate, Carriage House Shingle, Presidential Shake TL Ultimate, Landmark TL Ultimate, Landmark TL Ultimate (Impact Resistant), Presidential Shake, Presidential Shake (Impact Resistant), Landmark Premium, Woodscape Premium and Independence offered by this warranty is designed to cover individual homeowners only. In the instance of shingles purchased by or installed upon property owned by, for example, corporations, governmental agencies, partnerships, trusts, religious organizations, schools, condominiums or cooperative housing arrangements, or installed on apartment buildings or any other type of building or premises not used by individual homeowners as their residence, the warranty period for Grand Manor Shingle, Centennial Slate, Carriage House Shingle, Presidential Shake TL Ultimate, Landmark TL Ultimate, Landmark TL Ultimate (Impact Resistant), Presidential Shake, Presidential Shake (Impact Resistant), Landmark Premium, Woodscape Premium and Independence will be 50 years following the installation of the shingles. Further, CertainTeed's maximum liability after the SureStart period will be calculated using the figure indicated in Table 1 as the maximum material liability, exclusive of costs of labor, roof tear-off, metal work, and disposal, and by then decreasing that amount by the reduction figure specified in Table 1 for each month as measured from the date the shingles were installed to the date when proven defective.

SureStart™ Protection

All of CertainTeed's shingle products are covered by SureStart™ protection for the period specified in Table 1. Under this warranty feature, CertainTeed, at no charge, will repair or replace, at its option, any shingles proven to be defective during the applicable SureStart period (the SureStart period begins when shingle application has been completed and terminates at the end of the year indicated as its term of duration; i.e., the SureStart period for Independence Shingle terminates at the completion of its fifth year of service). CertainTeed's maximum material liability under SureStart will be equal to the reasonable cost to replace the defective shingles, plus labor. CertainTeed shall not be responsible or liable for costs of roof tear-off and disposal and of flashing and metal work (and repairs required by defects therein) except for Grand Manor Shingle, Centennial Slate, Carriage House Shingle, Presidential Shake TL Ultimate, Landmark TL Ultimate, Landmark TL Ultimate (Impact Resistant), Presidential Shake, and Presidential Shake (Impact Resistant) for which CertainTeed's maximum liability will also include the cost of roof tear-off and disposal.

SureStart protection does not extend to any shingles applied to any non-ventilated or inadequately ventilated roof deck systems, except as stated on page 6. In the case of these shingles, CertainTeed's maximum contribution toward the cost of repairing, replacing or cleaning the defective shingles will be calculated using the figure indicated in Table 1 as the maximum material liability, exclusive of costs of labor, roof tear-off and disposal, and by then decreasing that amount by the reduction figure (related to shingles applied to an inadequately ventilated roof deck) for each month as measured from the date the shingles were installed to the date when proven defective.

In instances in which CertainTeed, under the terms of this warranty, has agreed to pay the cost of labor required to repair, replace or clean defective or contaminated shingles, CertainTeed will provide reimbursement only upon receipt of a copy of the contractor's invoice or other written evidence of the completion of such work which CertainTeed, in its sole discretion, deems acceptable.

Please refer to next page for remainder of warranty, including other conditions.

TABLE I

Product	Warranty Period	SureStart™ Period	Wind Warranty MPH	Algae Resistant Warranty Period**	Maximum Material Liability After SureStart Period	Reduction Figure Per Month
GRAND MANOR SHANGLE®	LIFETIME	10 YEARS	110	15	\$140/Square	1/600*
CENTENNIAL SLATE™	LIFETIME	10 YEARS	110	15	\$130/Square	1/600*
CARRIAGE HOUSE SHANGLE™	LIFETIME	10 YEARS	110	15	\$110/Square	1/600*
PRESIDENTIAL SHAKE™ TL ULTIMATE (& AR)	LIFETIME	10 YEARS	110	15	\$140 Square	1/600*
LANDMARK™ TL ULTIMATE (& AR) (& IMPACT RESISTANT)	LIFETIME	10 YEARS	110	15	\$120/Square	1/600*
PRESIDENTIAL SHAKE™ (& AR)	LIFETIME	10 YEARS	110	15	\$95/Square	1/600*
LANDMARK™ PREMIUM/ARCHITECT 80 (& AR)	LIFETIME	10 YEARS	90††	10xxx	\$55/Square	1/600*
WOODSCAPE® PREMIUM	LIFETIME	10 YEARS	90††	10	\$55/Square	1/600*
INDEPENDENCE SHANGLE® (& AR)	LIFETIME	5 YEARS	110	10	\$55/Square	1/600*
LANDMARK™ SPECIAL	50 YEARS	5 YEARS	90††	10	\$55/Square	1/480
HATTERAS®	40 YEARS	5 YEARS	110	10	\$55/Square	1/480
LANDMARK™ PLUS (& AR)	40 YEARS	5 YEARS	80††	10	\$45/Square	1/480
HALLMARK SHANGLE®	40 YEARS	5 YEARS	80	N/A	\$55/Square	1/480
XT™ 30 (& AR) (& IMPACT RESISTANT)	30 YEARS	5 YEARS	70†††	10	\$35/Square	1/360
LANDMARK™ (& AR)	30 YEARS	5 YEARS	70††	10	\$40/Square	1/360
WOODSCAPE® AR	30 YEARS	5 YEARS	70††	10	\$40/Square	1/360
PATRIOT™	30 YEARS	5 YEARS	70	10	\$40/Square	1/360
CLASSIC HORIZON SHANGLE® (& AR)	30 YEARS	5 YEARS	70	10	\$40/Square	1/360
NEW HORIZON SHANGLE®	30 YEARS	5 YEARS	70	N/A	\$40/Square	1/360
XT™ 25 (& AR)/SEAL KING® 25 (& AR)	25 YEARS	5 YEARS	60	10	\$30/Square	1/300
JET® 25	25 YEARS	4 YEARS	60	N/A	\$30/Square	1/300
CT20 (& AR)	20 YEARS	3 YEARS	60	10	\$25/Square	1/240
ANY SHINGLES APPLIED TO ANY INADEQUATELY VENTILATED ROOF DECK	10 YEARS†	N/A	N/A	N/A	See Above	1/120

* For Grand Manor Shingle, Centennial Slate, Carriage House Shingle, Presidential Shake TL Ultimate, Landmark TL Ultimate, Landmark TL Ultimate (Impact Resistant), Presidential Shake, Presidential Shake (Impact Resistant), Landmark Premium, Woodscape Premium and Independence at the completion of the 40th year the reduction figure will remain at 480/600, or 20% of the total maximum liability.

** Algae Resistant Warranty period cited is only applicable to Algae Resistant version of the pertinent shingle.

xxx Algae resistant warranty 15 years, Hawaii only.

† For details of warranty coverage for shingles installed on inadequately ventilated roof decks on both residential and commercial buildings, see provisions on page 6 under “Inadequately Ventilated and Non-Ventilated Decks.”

†† Laminate wind warranty upgrade. Roof shingles shall be resistant to blow-off due to wind velocities, including gusts, up to a maximum of 110 miles per hour for Landmark Premium, Landmark Special and Woodscape Premium during the first ten (10) year and 90 mph for Landmark Plus and 80 mph for Landmark and Woodscape, during the first five (5) years following application, provided that the shingles are installed using six (6) nails, in the common bond area, per shingle.

CertainTeed warrants that Landmark TL Ultimate (Impact Resistant), Landmark Special, Presidential Shake (Impact Resistant) and XT30 (Impact Resistant) are compliant with UL 2218 Impact Resistance of Prepared Roof Covering Materials test criteria at time of manufacture.

††† Wind warranty for XT30 (& AR) (& Impact Resistant) for the Northwest region is 80 mph. Wind warranty is 110 mph in Hawaii only.

Flintlastic™ SA (Self-Adhering) System

For small low slope residential roofing projects – less than 20 squares (such as decks, additions and porches) – CertainTeed offers the following 12-year SureStart membrane warranty on our two-ply system consisting of Flintlastic™ SA Nail Base and Flintlastic SA Cap sheet, providing the system has been applied in accordance with CertainTeed’s current written installation instructions.

CertainTeed warrants the roof membrane for a period of 12 years from the date of completion of the roof membrane installation. During the duration of this warranty, CertainTeed will repair the roof membrane as necessary to retain the membrane in a watertight condition. Only leaks or other membrane deficiencies that result from manufacturing defects are covered by this warranty. CertainTeed and/or its designated roofing contractor will repair, at CertainTeed’s expense, such leaks or other membrane deficiencies covered by the warranty as necessary to retain the roof membrane in a watertight condition. CertainTeed is not responsible for any costs related to the removal or abatement of any asbestos

present in any existing roofing system to which the CertainTeed roofing membrane is applied. The roof membrane referred to herein shall include the following components: a base sheet and a cap sheet applied per CertainTeed published specifications. The roof components which are not part of the roof membrane and hence NOT covered by this warranty are the following: underlying roof deck, insulation, vapor retarders, fasteners, metal work, drains, skylights, vents, plastic accessories, any flashing, decorative or reflective coating, surfacing and/or any ballast, rock or gravel.

Beyond SureStart™ Protection

Should any shingles prove to be defective subsequent to the SureStart™ period, CertainTeed's maximum contribution toward the cost of repairing or replacing the defective shingles will be calculated using the figure indicated in Table 1 as the maximum material liability, exclusive of costs of labor, roof tear-off and disposal, and by then decreasing that amount by the specified reduction figure for each month as measured from the date the shingles were installed to the date when proven defective.

Transferability

DURING THE SURESTART PERIOD

This limited warranty is transferable by the original property owner/consumer to the first subsequent property owner provided that the first subsequent property owner gives written notice to CertainTeed within 60 days from the date of real estate title transfer. (Notice should be sent to RPG Technical Services Department, 1400 Union Meeting Road, Blue Bell, PA 19422.)

With respect to Grand Manor Shingle, Centennial Slate, Carriage House Shingle, Presidential Shake TL Ultimate, Presidential Shake, Presidential Shake (Impact Resistant), Landmark TL Ultimate, Landmark TL Ultimate (Impact Resistant), Landmark Premium, Woodscape Premium if this warranty is effectively transferred as described in the paragraph above during the ten (10) year SureStart period, the duration of the warranty will be 50 years measured from the date of installation, and the remaining period of SureStart protection will be available to the subsequent property owner.

AFTER THE SURESTART PERIOD

In the event that the warranty is transferred by the original property owner/consumer subsequent to the SureStart period, the warranty duration following the transfer will be two years from the date of real estate title transfer, and the warranty obligation will be calculated as explained in the above section titled "Beyond SureStart Protection."

Limitations

This warranty does not provide protection against any failure, defect or damage caused by situations and events beyond normal exposure conditions, including but not limited to:

- winds, including gusts, greater than those listed in Table 1 for each product, lightning, hurricane (see Limited Wind Warranty for hurricane wind exception), tornado, hailstorm, earthquake, fire, explosion, flood or falling objects.
- distortion, cracking or other failure, or movement of the base material over which the shingles are applied, or of the roof deck, or of the walls or foundation of the building itself.
- damage caused by structural changes, alterations or additions, or by the installation of equipment (such as aerials, signs or air-conditioning equipment) to the structure after the original shingles have been applied.
- stains or contamination to the shingle arising from sources such as, but not limited to, moss, lichens or other vegetation, mold or mildew growth, or paints, chemicals or other similar materials, unless the applied asphalt shingle was sold as an "algae-resistant shingle," in which case CertainTeed will clean, repair or replace, at its option, per the terms of the warranty, only such shingles which are proven to be contaminated with algae during the term of the warranty against algae growth.
- misuse, abuse or improper handling or storage of CertainTeed shingles.
- installation of shingles over non-approved roof decks as fully explained in the CertainTeed *Shingle Applicator's Manual*.
- damage to CertainTeed shingles, the roof deck or the structure caused by ice backup or ice damming.
- improper application or application not in accordance with CertainTeed's current written installation instructions.

Mold and mildew are functions of environmental conditions and are not manufacturing defects. As such, mold and mildew are not covered by this warranty or any implied warranty.

CertainTeed reserves the right to discontinue or modify any of its products, including the color of the shingles, and shall not be liable as a result of such discontinuance or modification, nor shall CertainTeed be liable in the event replacement material varies in color in comparison to the original product as a result of normal weathering. If CertainTeed replaces any material under this warranty, it may substitute products designated by CertainTeed to be of comparable quality or price range in the event the product initially installed has been discontinued or modified.

WARNING: FOR LOW-VOLUME RAIN AND SALT-FOG AREAS

In areas of low-volume rain (defined as insignificant rainfall during a 90-day period) and "salt fog," such as parts of the Southern California coastline, copper released by algae-resistant (AR) granules can react with the aluminum in gutters, leading to severe corrosion of the gutters. Therefore, in such regions, it is strongly recommended that aluminum gutters not be used with algae-resistant shingles. Vinyl or copper gutters are recommended.

CertainTeed disclaims all liability and responsibility for any damages that may be incurred by the use of its algae-resistant shingle products containing copper granules where aluminum gutters are used.

In any instance in which the shingles qualify for only a 10-year warranty, CertainTeed's obligation will be calculated by using both the maximum material liability and applicable monthly reduction figure shown in Table 1 related to shingles applied to an inadequately ventilated roof deck.

Please refer to next page for remainder of warranty, including other conditions.

Inadequately Ventilated and Non-Ventilated Decks

Any shingles applied to inadequately ventilated or non-ventilated decks, other than the shingles and deck systems described in the paragraph below, titled "Insulated Decks and Radiant Barriers," shall qualify for a reduced warranty duration of 10 years with no SureStart coverage, with respect to shingle problems related to the absence of adequate roof system ventilation.

Insulated Decks and Radiant Barriers

CertainTeed's Limited Asphalt Shingle Warranty, including SureStart™ coverage, will remain in force when its fiber glass asphalt shingles manufactured to meet ASTM D3462 are applied to roof deck assemblies (slopes $\geq 2:12$) where foam insulation is prefabricated into the roof deck system (often called "nailboard insulation"), where insulation is installed beneath an acceptable roof deck system, or where radiant barriers are installed, with or without ventilation directly below the deck. Acceptable roof deck surfaces must consist of either minimum $\frac{3}{8}$ " thick plywood or minimum $\frac{7}{16}$ " thick OSB. If an alternate deck surface material is being considered, contact CertainTeed Technical Services. ***See the following important restrictions.***

The design professional is responsible for ensuring 1) proper quality and application of the insulation and/or radiant barrier, 2) provision of adequate structural ventilation and/or vapor retarders as determined to be necessary, and 3) that all local codes are met (particularly taking into account local climate conditions). Special attention must be taken if cellular foam, fiber glass, or cellulose insulations, or other highly-permeable insulation will be used in an unventilated system, or if the insulation/rafter or insulation/joist planes may create an air leak that could lead to moisture transmission and condensation problems. *All these important factors and decisions, while **not** the responsibility of CertainTeed Corporation, are critical to assure proper deck system performance.*

Ventilated Nail-Base Roof Insulation

Ventilated Nail-Base Roof Insulation products consist of rigid insulation (typically foam board) and some sort of material to provide air space above the insulation and below a nailable deck (which is typically minimum $\frac{7}{16}$ " thick OSB or minimum $\frac{3}{8}$ " plywood). These products can be a satisfactory way to provide soffit-to-ridge ventilation over cathedral-type ceilings, and their proper use will allow CertainTeed's Limited Asphalt Shingle Warranty to be unreduced. It is important to follow the deck manufacturer's instructions and ensure that sufficient ventilation is achieved. CertainTeed offers FlintBoard™ CV — cross-ventilating insulation boards with 1", 1 $\frac{1}{2}$ " and 2" air channels.

Limited Wind Warranty

CertainTeed warrants both its fiber glass asphalt shingles and its organic-base asphalt shingles to resist blow-off damage due to wind velocities, including gusts, and including hurricane winds where applicable (over 74 mph) during the first ten (10) years following application for Grand Manor Shingle, Centennial Slate, Carriage House Shingle, Presidential Shake TL Ultimate, Landmark TL Ultimate, Landmark TL Ultimate (Impact Resistant), Presidential Shake, Presidential Shake (Impact Resistant), Landmark Premium, Woodscape Premium and Hatteras shingles. All other shingle products are warranted to resist blow-off damage due to wind velocities, including gusts, up to the maximum wind velocity per product listed in Table 1 (including hurricane winds where applicable) during the first five (5) year period following application of the shingles.

If any such blow-off damage does occur during those initial time periods after application, CertainTeed will furnish replacement shingles without charge for those shingles damaged (but will not be responsible for labor costs pertaining to removal or replacement of damaged shingles). If the applied shingles contain self-sealing asphalt strips, and if any of these strips fail to activate within the first year following application, CertainTeed shall have no liability under this warranty for such a defect unless CertainTeed is afforded the opportunity to hand-seal, at its expense, any non-sealing shingles.

Any costs in excess of CertainTeed's contribution shall be the owner's responsibility through homeowner's insurance, etc.

What the Customer Must Do

The property owner must promptly notify CertainTeed in writing of any manufacturing defect or algae contamination and provide proof of the date of purchase and date of application of the shingles. CertainTeed will then investigate the claim, and if a defect covered by this warranty is confirmed, CertainTeed, within a reasonable amount of time after inspecting the shingle, will repair, replace or clean the defective shingles or reimburse the property owner the appropriate amount for the repair, replacement or cleaning of the shingles under the terms of the warranty.

All notifications should be sent to: CertainTeed, 1400 Union Meeting Road, Blue Bell, PA 19422

Attn: RPG Technical Services Department, Telephone number: 800-345-1145

Warranty Registration (not required)

CertainTeed would like to offer you a way to safeguard your investment by registering your product warranty on the CertainTeed Website at www.certainteed.com/warranty. You will then receive a numbered registration confirmation by return e-mail that can be printed out and kept with this warranty document and your proof of purchase. Failure to register this warranty shall NOT void the warranty or any of its terms. **For those without internet access please feel free to provide us with your complete name, address and phone number; the name and contact information for your roofing contractor and the name of the shingle, number of squares, color and installation date.** We will register the information for you and mail you the confirmation.

**Mail to CertainTeed Corporation, Roofing Products Group
P.O. Box 860, Valley Forge, PA 19482.**

Please refer to back page for remainder of warranty, including other conditions.

WHAT IS A SELF-SEALING STRIP?

Most shingles contain a factory applied self-sealing asphalt strip which must be subjected to direct sunlight for several days before sealing will occur. Shingles installed in the fall or winter may not seal until the following spring. Shingles which do not receive direct sunlight or which are not exposed to adequate surface temperatures may never seal and must be hand sealed at time of application. Improper installation of shingles, or damage to the factory applied self-sealing strip by dust, sand, or foreign matter, will prevent the sealing strip from activating. Failure of the shingles to seal under any of the above circumstances is **not** a manufacturing defect and CertainTeed will not be responsible for repairing, replacing or hand-sealing any shingles under any such circumstance.

WHAT IS A “SHANGLE® ”?

The “Shangle®,” an idea conceived by CertainTeed over 35 years ago, is the original “laminated shingle.” The Shangle features a full-size, one-piece shingle as a base, to which individual shingle tabs or overlay pads are applied, providing extra protection and aesthetic enhancement to the roof.

A *Super Shangle®* takes this idea one step further by using it on an 18" x 36" base layer, adding another shingle layer and the shingle tabs.

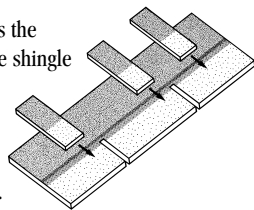

WHAT IS A TRI-LAMINATE™?

Our patented Tri-Laminate™ process combines three layers of the industry’s most durable materials into an exceptionally strong, dramatically thick roofing product styled with the classic appeal of wood shakes. The stunning, 3-dimensional appearance of CertainTeed’s Super Shake™ products gives your roof tremendous depth and distinction beyond comparison.

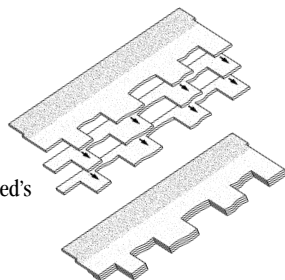

WHAT IS A TWO-PIECE LAMINATE?

Whereas a Shangle consists of a full-size, one-piece base shingle onto which tabs or pads are applied, a two-piece laminate uses a full-size shingle with tab-size teeth cut out of it. Adhered to the back of this top shingle is a half shingle that runs behind the cutouts. The result is a multi-layered shingle that provides a rugged, textured look on the roof.

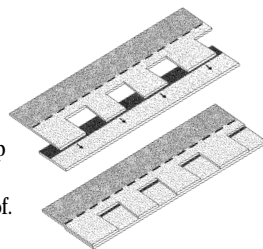

WHAT IS AN ALGAE-RESISTANT SHINGLE?

Many of CertainTeed’s fiber glass shingles are available in an algae-resistant version. Commonly, although incorrectly, called “fungus,” the black and green algae that creates unsightly streaking on shingles is a common occurrence in warm, humid climates. CertainTeed AR shingles carry an exceptional 10- or 15-year limited warranty against algae contamination.

FOR YOUR RECORDS ONLY:

Product Purchased _____ Date of Installation _____

Roofing Contractor _____ Contractor's Phone No. _____

This warranty, which is effective on shingles applied on or after January 1, 2007, supersedes the written warranty previously issued by CertainTeed coded No. 20-20-1954.

THIS WARRANTY REPLACES ALL OTHER ORAL OR WRITTEN WARRANTIES, LIABILITIES OR OBLIGATIONS OF CERTAINTEED. APPLICABLE STATE LAW WILL DETERMINE THE PERIOD OF TIME FOLLOWING THE SALE THAT A PROPERTY OWNER/CONSUMER MAY SEEK A REMEDY UNDER THE IMPLIED WARRANTY OF MERCHANTABILITY OR FITNESS FOR A PARTICULAR PURPOSE. IN NO EVENT SHALL CERTAINTEED BE LIABLE FOR CONSEQUENTIAL OR INCIDENTAL DAMAGES OF ANY KIND, INCLUDING ANY DAMAGE TO THE BUILDING, ITS CONTENTS OR ANY PERSONS THEREIN, RESULTING FROM THE BREACH OF THIS WARRANTY. NO FIELD REPRESENTATIVE, DISTRIBUTOR OR DEALER OF CERTAINTEED IS AUTHORIZED TO CHANGE OR MODIFY THIS WARRANTY. SOME STATES DO NOT ALLOW THE EXCLUSION OR LIMITATION OF INCIDENTAL OR CONSEQUENTIAL DAMAGES, SO THE ABOVE EXCLUSIONS MAY NOT APPLY TO YOU.

This warranty gives you specific legal rights, and you may also have other rights that vary from state to state.

ROOFING PLANTS AND REGIONAL SALES OFFICES

CertainTeed roofing products are sold by the Roofing Products Group of CertainTeed Corporation in eight sales regions. They are manufactured in eleven residential roofing plants and two commercial roofing plants.



Since the early 1900s, CertainTeed Corporation has been an innovator in the building materials industry and today is a leading manufacturer of building materials including residential and commercial roofing, vinyl and fiber cement siding, vinyl windows, composite decking and railing, fiber glass insulation, vinyl fence, and piping products. The company is headquartered in Valley Forge, Pennsylvania, and employs more than 7,000 employees at approximately 50 manufacturing facilities throughout North America. Continuing the 100-year commitment of "quality made *certain*, satisfaction guaranteed," CertainTeed remains one of the most trusted names in the industry. More information is available at www.certainteed.com.

This document is available in Spanish. Call 1-800-782-8777. (Note: The operators do not speak Spanish.)
Se puede obtener este documento en español. Favor de llamar 1-800-782-8777. (Los operadores no hablan español.)

ASK ABOUT OUR OTHER CERTAINTEED PRODUCTS AND SYSTEMS:

EXTERIOR: ROOFING • SIDING • WINDOWS • FENCE • DECKING
RAILING • MILLWORK • FOUNDATIONS • PIPE
INTERIOR: INSULATION • WALLS • CEILINGS

CertainTeed Corporation
P.O. Box 860
Valley Forge, PA 19482

Professional: 800-233-8990
Consumer: 800-782-8777
www.certainteed.com

CertainTeed 

CertainTeed

2008 Limited Warranty

Asphalt Shingle Products



CertainTeed 

Quality made certain. Satisfaction guaranteed.™

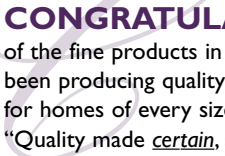

CONGRATULATIONS! ... and thank you for your recent purchase of one of the fine products in the CertainTeed Roofing Collection.™ Since 1904, CertainTeed has been producing quality roofing products that provide long-lasting beauty and protection for homes of every size, style and age. For over 100 years, the basis for our name, “Quality made certain, satisfaction guaranteed,” has been our ongoing philosophy.

Your CertainTeed roofing warranty fully explains how CertainTeed supports its products with the strongest warranty protection available. It is important that you read the warranty section of this brochure. The warranty lists the specific CertainTeed asphalt shingle products that are covered and the period of time for which they are covered. Take the time to understand how CertainTeed protects your purchase by standing behind our products.

SURESTART™ PROTECTION

Because CertainTeed roofing products are manufactured to the highest quality standards, we confidently include the additional assurance of SureStart™ protection with all CertainTeed shingles. SureStart provides the strongest protection you can get in the vital early years of your new roof.

Simply put, if a manufacturing defect is discovered during the SureStart period, CertainTeed will provide reimbursement of 100% of the reasonable cost of the shingles and labor to repair the defective shingles or apply new shingles to replace the defective shingles (exclusive of costs of tear-off, metal work and disposal). SureStart protection begins on the date of application and is not prorated or otherwise reduced during the SureStart period.

See page 3 – SureStart Protection – for further details. SureStart protection does not extend to any shingles applied to any non-ventilated or inadequately ventilated roof deck systems, except as stated on page 6.

TRANSFERABILITY

The warranty for CertainTeed shingles is transferable by the original property owner/consumer to the first subsequent owner. If transferred during the product's SureStart period, the warranty for the new owner is the same as it would have been for the original owner, except for products with lifetime warranty periods where the duration of the transferred warranty will be 50 years measured from the beginning of the SureStart period. If the warranty is transferred after the SureStart period has elapsed, the duration of the transferred warranty is limited to no more than **two** years from the date of real estate title transfer.

See page 5 – Transferability – for further details.

LIMITED, PRORATED AND TRANSFERABLE WARRANTY

This warranty covers asphalt shingle products listed in Table 1, sold only in the United States of America, its territories and Canada.

What and Who Is Covered and for How Long

CertainTeed warrants to the original property owner/consumer that, when subject to normal and proper use, its shingles will be free from manufacturing defects for the length of time specified in Table 1 and that CertainTeed will pay to repair, replace or clean at its option, any shingles CertainTeed determines are defective under the terms of this warranty. In the event of repair, replacement or cleaning pursuant to the terms of this limited warranty, the warranty applicable to the original shingles shall apply to the repaired, replaced or cleaned shingles and will extend for the balance of the original warranty period.

The Lifetime warranty period offered for certain shingles in Table I is only available to individual homeowners. The warranty period for shingles installed on premises not used by individual homeowners as their residence is limited to 50 years following the installation of the shingles. All other structures and property owners (e.g., corporations, governmental agencies, partnerships, trusts, religious organizations, schools, condominiums, homeowner associations or cooperative housing arrangements, apartment

buildings, and any other type of building or premises not owned by individual homeowners) are limited to a 50-year warranty period.

SureStart™ Protection

All of CertainTeed's shingle products are covered by SureStart protection. Under this warranty feature, CertainTeed, at no charge, will pay to repair, replace or clean, at its option, any shingles CertainTeed determines are defective or adversely affected by algae during the SureStart period. The SureStart period begins on the date of application and terminates following the period specified in Table 1. CertainTeed's maximum liability under SureStart is equal to the reasonable cost of shingles and labor to replace or repair the defective shingles. Roof tear-off, metal work, flashing and disposal expenses, and other costs or expenses incurred during such repair or replacement are not covered or reimbursed by this Limited Warranty, except for products with lifetime warranty periods, for which CertainTeed's maximum liability also includes the cost of roof tear-off and disposal.

SureStart protection does not extend to any shingles applied to non-ventilated or inadequately ventilated roof deck systems, except as stated on page 6. CertainTeed's maximum contribution towards the cost of repairing, replacing or cleaning defective shingles applied to a non-ventilated or inadequately ventilated roof deck system is calculated using the Maximum Material Liability After SureStart figure specified in Table 1, less 1/120th of that amount times the number of months from the start of the warranty period to the date when CertainTeed determines the shingles are defective. Labor costs, roof tear-off, metal work, flashing and disposal expenses, and other costs or expenses incurred during such repair or replacement are not covered or reimbursed by this Limited Warranty.

In instances in which CertainTeed, under the terms of this warranty, has agreed to pay the cost of labor required to repair, replace or clean defective or contaminated shingles, CertainTeed will provide reimbursement only upon receipt of a copy of the contractor's invoice or other written evidence of the completion of such work which CertainTeed, in its sole discretion, deems acceptable.

Product	Warranty Period	SureStart™ Period	Wind Warranty MPH	Algae Resistant Warranty Period**	Maximum Material Liability After SureStart Period	Reduction Figure Per Month
GRAND MANOR SHANGLE®	LIFETIME	10 YEARS	110	15	\$140/Square	1/600*
CENTENNIAL SLATE™	LIFETIME	10 YEARS	110	15	\$130/Square	1/600*
CARRIAGE HOUSE SHANGLE™	LIFETIME	10 YEARS	110	15	\$110/Square	1/600*
PRESIDENTIAL SHAKE™ TL (& AR)	LIFETIME	10 YEARS	110	15	\$140 Square	1/600*
LANDMARK™ TL (& AR) (& IMPACT RESISTANT)***	LIFETIME	10 YEARS	110††	15	\$120/Square	1/600*
PRESIDENTIAL SHAKE™ (& AR) (& IMPACT RESISTANT)***	LIFETIME	10 YEARS	110	15	\$95/Square	1/600*
LANDMARK™ PREMIUM/ARCHITECT 80 (& AR)	LIFETIME	10 YEARS	90††	10xxx	\$55/Square	1/600*
WOODSCAPE® PREMIUM	LIFETIME	10 YEARS	90††	10	\$55/Square	1/600*
INDEPENDENCE SHANGLE® (& AR)	LIFETIME	5 YEARS	110	10	\$55/Square	1/600*
LANDMARK™ SPECIAL	50 YEARS	5 YEARS	90††	10	\$55/Square	1/600
HATTERAS®	40 YEARS	5 YEARS	110	10	\$55/Square	1/480
LANDMARK™ PLUS (& AR)	40 YEARS	5 YEARS	80††	10	\$45/Square	1/480
HALLMARK SHANGLE®	40 YEARS	5 YEARS	80	N/A	\$55/Square	1/480
XT™ 30 (& AR) (& IMPACT RESISTANT)***	30 YEARS	5 YEARS	70†††	10	\$35/Square	1/360
LANDMARK™ (& AR)	30 YEARS	5 YEARS	70††	10	\$40/Square	1/360
WOODSCAPE® AR	30 YEARS	5 YEARS	70††	10	\$40/Square	1/360
PATRIOT™	30 YEARS	5 YEARS	70	10	\$40/Square	1/360
CLASSIC HORIZON SHANGLE® (& AR)	30 YEARS	5 YEARS	70	10	\$40/Square	1/360
NEW HORIZON SHANGLE®	30 YEARS	5 YEARS	70	N/A	\$40/Square	1/360
XT™ 25 (& AR)/SEAL KING® 25 (& AR)	25 YEARS	5 YEARS	60	10	\$30/Square	1/300
CT 20 (& AR)	20 YEARS	3 YEARS	60	10	\$25/Square	1/240
ANY SHINGLES APPLIED TO ANY INADEQUATELY VENTILATED ROOF DECK	10 YEARS†	N/A	N/A	N/A	See Above	1/120

“The Lifetime Warranty period is only available to individual homeowners. The warranty period for shingles installed on premises not used by individual homeowners as their residence is limited to 50 years following the installation of the shingles. All other structures and property owners (e.g., corporations, governmental agencies, partnerships, trusts, religious organizations, schools, condominiums, homeowner associations or cooperative housing arrangements, apartment buildings, and any other type of building or premises not owned by individual homeowners) and Limited Warranty transferees are limited to a 50 year warranty period.

** For Grand Manor Shingle, Centennial Slate, Carriage House Shingle, Presidential Shake TL, Landmark TL, Landmark TL (Impact Resistant), Presidential Shake, Presidential Shake (Impact Resistant), Landmark Premium, Woodscape Premium and Independence, at the completion of the 40th year the reduction figure will remain at 480/600, or 20% of the total maximum liability.*

*** Algae Resistant Warranty period is only for the Algae Resistant (AR) version of the pertinent shingle.*

xxx Algae Resistant Warranty for this product is 15 years in Hawaii.

**** CertainTeed warrants that its Landmark TL (Impact Resistant), Landmark Special, Presidential Shake (Impact Resistant) and XT30 (Impact Resistant) shingles comply with UL 2218 Impact Resistance of Prepared Roof Covering Materials test criteria at time of manufacture.*

† For details of warranty coverage for shingles installed on inadequately ventilated roof decks on both residential and commercial buildings, see provisions on page 6 under “Inadequately Ventilated and Non-Ventilated Decks.”

†† Wind warranty upgrade – Landmark Premium, Landmark Special, Landmark Plus, Landmark TL and Woodscape Premium roof shingles are warranted to resist blow-off due to wind velocities, including gusts, up to a maximum of 130 miles per hour during the first ten (10) years; Landmark and Woodscape roof shingles are warranted to resist blow-off due to wind velocities, including gusts, up to a maximum of 110 mph for during the first five (5) years of the warranty, provided all of the following conditions are met:

- CertainTeed SwiftStart starter shingles are installed along the roof eaves and rakes (Note: Universal 7" starter shingles are installed in the CertainTeed N.E. region instead of SwiftStart).*
- CertainTeed Shadow Ridge™ or Mountain Ridge™ hip and ridge accessory products are installed as cap shingles.*

††† Wind warranty for XT30 (E AR) (E Impact Resistant) for the Northwest region is 80 mph. Wind warranty is 100 mph in Hawaii and Alaska only.

Flintlastic™ SA (Self-Adhering) System

For low slope residential roofing projects with less than 20 squares, CertainTeed offers a 12-year SureStart membrane warranty on its two-ply system consisting of a Flintlastic SA Nail Base and a Flintlastic SA Cap sheet, provided the system was applied in accordance with CertainTeed’s current installation instructions published at the time of installation.

CertainTeed warrants the roof membrane, subject to the following terms, conditions, limitations, and exclusions, for a period of 12 years from the date of installation: If a manufacturing defect in the roof membrane causes a leak, CertainTeed or its designated roofing contractor will, at CertainTeed’s expense, repair the roof membrane as necessary to restore it to a watertight condition. Only manufacturing defects in the roof membrane that cause leaks are covered by this warranty. Roof membrane, as used herein, shall include the following components: a base sheet and a cap sheet. The roof components which are not part of the roof membrane and hence NOT covered by this warranty are the following: underlying roof deck, insulation, vapor retarders, fasteners, metal work, drains, skylights, vents, plastic accessories, all types of flashing, decorative or reflective coating, surfacing and/or any ballast, rock or gravel. In no event, however, will CertainTeed be responsible for any costs related to the removal or abatement of any asbestos present in any existing roof system to which the CertainTeed roof membrane is applied.

Beyond SureStart Protection

If CertainTeed determines its shingles are defective after the SureStart period, CertainTeed’s maximum contribution towards the cost of repairing, replacing, or cleaning defective shingles will be calculated using the Maximum Material Liability After SureStart figure specified in Table 1, less the Monthly Reduction Figure from the start of the warranty period to the date when CertainTeed determines the shingles are defective. Labor costs, roof tear-off, metal work, flashing and disposal expenses, and other costs or expenses incurred during such repair or replacement are not covered or reimbursed by this Limited Warranty.

Transferability

This Limited Warranty is transferable, but only by the original property owner/consumer to one subsequent property owner. After the Limited Warranty has been transferred once, it is no longer transferable. The warranty transfer is only effective if the subsequent property owner provides written notice of the transfer to CertainTeed within sixty (60) days from the real estate title transfer date. (Notice must be sent to CertainTeed Roofing Technical Services Department, 1400 Union Meeting Road, Blue Bell, PA 19422).

Transfers During the SureStart Period

If this Limited Warranty is transferred during the product's SureStart period, the warranty for the new owner is the same as it would have been for the original owner, except for products with lifetime warranty periods where the duration of the transferred warranty will be 50 years measured from the beginning of the SureStart period (i.e. the date of installation), and the remaining period of SureStart protection will be available to the subsequent property owner.

Transfers After the SureStart Period

If this Limited Warranty is transferred by the original property owner/consumer after the SureStart period, the warranty following the transfer will be limited to two (2) years from the date of real estate title transfer. The warranty obligation will be calculated as explained in the section above titled "Beyond SureStart Protection."

Limitations

This Limited Warranty does not provide protection against and CertainTeed will have no liability for any failure, defect or damage caused by situations and events beyond normal exposure conditions, including but not limited to:

- Winds, including gusts, greater than the Wind Warranty figures in Table 1, lightning, hurricanes (see Limited Wind Warranty for hurricane wind exception), tornado, hailstorm, earthquake, fire, explosion, flood or falling objects.
- Distortion, cracking or other failure or movement of the base material over which the shingles are applied, of the roof deck, or of the walls or foundation of the building itself.
- Damage caused by structural changes, alterations or additions, or by the installation of equipment (such as, but not limited to, aerials, signs or air-conditioning equipment) to the structure after the original shingles have been applied.
- Shading, stains or discoloration to the shingles arising from outside sources such as but not limited to algae (unless the shingle is AR), fungus, moss, lichens or other vegetation, mold or mildew growth, or paints, chemicals or other similar materials.
- Misuse, abuse, neglect, or improper transportation, handling or storage of the shingles.
- Installation of the shingles over non-approved roof decks as more fully explained in CertainTeed's installation instructions.
- Damage caused by improper installation or installation not in accordance with CertainTeed's installation instructions published at the time of original installation.
- Damage to the shingles, the roof deck or the structure caused by ice backup or ice damming.
- Vandalism or acts of war.
- Any other cause not a result of a manufacturing defect in the shingles.

Mold and mildew are functions of environmental conditions and are not manufacturing defects. As such, mold and mildew are not covered by this Limited Warranty or any implied warranty.

CertainTeed reserves the right to discontinue or modify any of its products, including the color of its shingles, and shall not be liable as a result of such discontinuance or modification, nor shall CertainTeed be liable in the event replacement material varies in color in comparison to the original product as a result of normal weathering. If CertainTeed replaces any material under this warranty, it may substitute products designated by CertainTeed to be of comparable quality or price range in the event the product initially installed has been discontinued or modified.

Where shingles only qualify for a 10-year warranty, CertainTeed's maximum material liability is calculated using the Maximum Material Liability After SureStart Period figure listed in Table 1, reduced by 1/120th of that amount times the number of months from the start of the warranty coverage period.

Inadequately Ventilated and Non-Ventilated Decks

Any shingles applied to inadequately ventilated or non-ventilated decks, other than the shingles and deck systems described in the section titled "Insulated Decks and Radiant Barriers," are subject to a reduced limited warranty period of ten (10) years and do not qualify for SureStart protection. SureStart protection and the

Warranty Period applicable to the shingle are available if the shingle damage was caused exclusively by a defect that is unrelated to the inadequate roof system ventilation.

Insulated Decks and Radiant Barriers

CertainTeed's Limited Warranty, including SureStart coverage, will remain in force when its fiber glass shingles are applied to roof deck assemblies where foam insulation is prefabricated into the roof deck system (often called "nailboard insulation"), where insulation is installed beneath an acceptable roof deck system, or where radiant barriers are installed, with or without ventilation directly below the deck. Acceptable roof deck surfaces must consist of at least 3/8" thick plywood or 7/16" thick Oriented Strand Board (OSB) and slopes must be > 2:12. If a different deck surface material will be utilized, please contact CertainTeed's Technical Services Department for assistance. (See the following important restrictions.)

The design professional is responsible for ensuring 1) proper quality and application of the insulation and/or radiant barrier, 2) provision of adequate structural ventilation and/or vapor retarders as determined to be necessary, and 3) that all local codes are met (particularly taking into account local climate conditions). Special attention must be taken if cellular foam, fiber glass, cellulose insulation or other highly-permeable insulation will be used in an unventilated system, or if the insulation/rafter or insulation/joist planes may create an air leak that could lead to moisture transmission and condensation problems. All these important factors and decisions, while not the responsibility of CertainTeed, are critical to assure proper deck system performance.

Ventilated Nail-Base Roof Insulation

Ventilated Nail-Base Roof Insulation products (e.g. Flint Board™ CV) are made of rigid insulation (typically foam board) and another layer of material that provides air space above the insulation and below the nailable deck (which is typically at least 7/16" thick "OSB" or 3/8" thick plywood). These products can provide soffit-to-ridge ventilation, and if installed in accordance with the deck manufacturer's instructions to achieve sufficient ventilation, will not reduce the scope or length of CertainTeed's Limited Warranty coverage.

Limited Algae Warranty

Black and green algae, which is commonly but incorrectly called "fungus," can create unsightly streaking on shingles. CertainTeed warrants that the Algae-Resistant (AR) versions of Grand Manor Shingle®, Centennial Slate™, Carriage House Shingle™, Presidential Shake™ TL, Landmark™ TL, and Presidential Shake™ shingles will remain free from algae growth (but not mold or mildew growth) which adversely affects the overall appearance of said shingles for a period of fifteen (15) years, and that Independence Shingle®, Hatteras®, Landmark™ Premium, Woodscape® Premium, Landmark™ Plus, Landmark™ Special, Landmark™, Woodscape®, Classic Horizon Shingle®, XT™ 30, Patriot™, XT™ 25/Seal King® 25 and CT 20 shingles will remain free from algae growth (but not mold or mildew growth) which adversely affects the overall appearance of said shingles for a period of ten (10) years.

WARNING: FOR LOW-VOLUME RAIN AND SALT FOG AREAS

In areas of low-volume rain (e.g. areas that receive insignificant rainfall during a 90-day period) and/or "salt fog" (e.g., parts of the Southern California coastline), copper released by algae-resistant (AR) granules or shingles can react with aluminum in gutters and cause severe corrosion of the gutters. In such regions, CertainTeed strongly recommends that vinyl or copper gutters, not aluminum gutters, be used with algae-resistant shingles. CertainTeed disclaims all liability and responsibility for any damages that may result from the use of its algae-resistant shingle products with copper granules where gutters containing aluminum are used.

Limited Wind Warranty

CertainTeed warrants its shingles will resist blow-off damage due to wind velocities, including gusts and hurricane winds up to the maximum wind velocity per the Wind Velocity speeds specified in Table I during the first ten (10) years of the warranty for Grand Manor Shingle®, Centennial Slate™, Carriage House Shingle™, Presidential Shake™ TL, Landmark™ TL, Presidential Shake™, Hatteras®, Landmark™ Premium, and Woodscape® Premium, and during the first five (5) years of the warranty for all other CertainTeed shingle products listed in Table 1 (the "Wind Warranty Period").

CertainTeed's obligations and liability for shingle blow-off damage during the Wind Warranty period are limited as follows:

- If shingles blow off because the shingle's self-sealing asphalt strips did not activate, CertainTeed will have no liability or warranty obligation unless CertainTeed is afforded the opportunity to hand seal, at its expense, any non-sealing shingles.
- If shingles blow off even though the shingle's self-sealing asphalt strips did activate, CertainTeed will furnish replacement shingles without charge, but only for damaged or blown off shingles. CertainTeed will not be responsible for or reimburse labor costs or any other costs pertaining to removal or replacement of damaged shingles. Any costs in excess of CertainTeed's material contribution are the property owner's responsibility (and may be covered by homeowner's insurance).
- CertainTeed shall have no liability for any damage to persons or property caused by blown off shingles.

What the Customer Must Do

If you believe your shingles have a manufacturing defect, you must promptly notify CertainTeed and provide proof of property ownership and the date of shingle purchase and application. Unless you provide such proof, CertainTeed will use the date of manufacture to calculate the start of the warranty period. In order to properly evaluate and process a warranty claim, CertainTeed may require the property owner to submit a shingle sample to CertainTeed for analysis and/or permit a CertainTeed representative to make repairs to, take photographs of, and/or take samples from the roof, if required. CertainTeed will evaluate each properly reported claim and will repair, replace, clean or reimburse the property owner for the shingles it determines are defective, in accordance with the terms of this Limited Warranty within a reasonable amount of time. For more details about submitting a warranty claim, visit www.ctroof.com or call (800) 345-1145.

Please send all notifications and correspondence to:

CertainTeed Corporation, 1400 Union Meeting Road, Blue Bell, PA 19422,

Attn: CertainTeed Roofing Technical Services Department. Telephone number: 800-345-1145.

Warranty Registration (not required)

You may register your product warranty on CertainTeed's website: www.certainteed.com/warrantyreg. Each registrant receives a registration confirmation number by return e-mail that can be printed and kept with this Limited Warranty and your proof of purchase. If you do not have internet access, you can register your shingles by sending: (1) your name, address, and telephone number; (2) the name and contact information of the contractor who installed your shingles and the original date of installation; and, (3) the type, color and number of squares of your shingles to:

CertainTeed Corporation, 1400 Union Meeting Road, Blue Bell, PA 19422,

Attn: CertainTeed Roofing Technical Services Department.

CertainTeed will register your information and mail you a confirmation number.

Failure to register this warranty does NOT void the warranty or any of its terms.

FOR YOUR RECORDS

Product Purchased: _____ Date of Installation: _____

Roofing Contractor: _____ Contractor's Telephone No. _____

This warranty applies to shingles installed on or after May 15, 2008.

(The warranty in effect at the time the material is originally installed is the applicable warranty.)

Limited Warranty and Limitation of Remedies

THE OBLIGATIONS CONTAINED IN THIS LIMITED WARRANTY CONSTITUTE THE EXCLUSIVE REMEDY AND ARE EXPRESSLY IN LIEU OF ANY AND ALL OTHER OBLIGATIONS, GUARANTEES AND WARRANTIES. APPLICABLE STATE LAW WILL DETERMINE THE PERIOD OF TIME FOLLOWING THE SALE THAT A PROPERTY OWNER/CONSUMER MAY SEEK A REMEDY UNDER THE IMPLIED WARRANTY OF MERCHANTABILITY OR FITNESS FOR A PARTICULAR PURPOSE. CERTAINTEED'S OBLIGATIONS, RESPONSIBILITIES, AND/OR LIABILITY SHALL BE LIMITED TO REPAIRING OR REPLACING THE DEFECTIVE PRODUCT OR PROVIDING A REFUND PER THE TERMS OF THIS LIMITED WARRANTY. IN NO EVENT SHALL CERTAINTEED BE LIABLE FOR ANY INCIDENTAL OR CONSEQUENTIAL DAMAGES, INCLUDING ANY DAMAGE TO THE BUILDING, ITS

CONTENTS, OR ANY PERSONS OR PROPERTY, THAT OCCUR AS A RESULT OF A BREACH. SOME STATES DO NOT ALLOW THE EXCLUSION OR LIMITATION OF INCIDENTAL OR CONSEQUENTIAL DAMAGES, SO THE ABOVE LIMITATION OR EXCLUSION MAY NOT APPLY TO YOU.

This Limited Warranty may not be modified, altered or expanded by anyone, including product distributors, dealers, sellers and/or CertainTeed field representatives.

This Limited Warranty gives you specific legal rights, and you may also have other rights which vary from State to State.

ROOFING PLANTS AND REGIONAL SALES OFFICES

CertainTeed roofing products are sold by CertainTeed Roofing in eight sales regions. They are manufactured in eleven residential roofing plants and two commercial roofing plants.

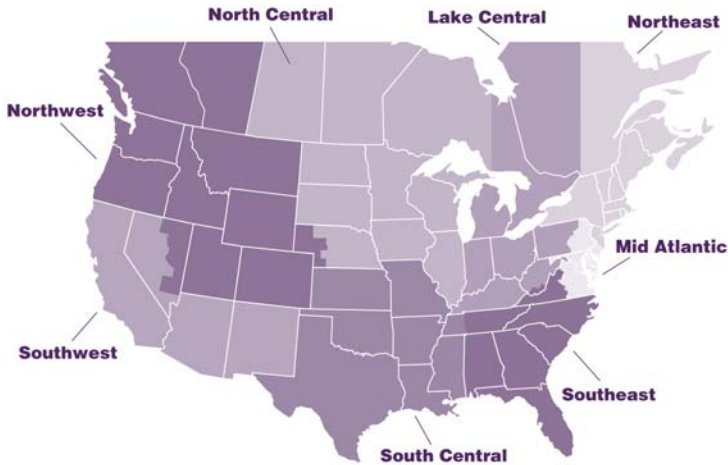

Since the early 1900s, CertainTeed Corporation has been an innovator in the building materials industry and today is a leading manufacturer of building materials including residential and commercial roofing, vinyl and fiber cement siding, vinyl windows, composite decking and railing, fiber glass insulation, vinyl fence, and piping products. The company is headquartered in Valley Forge, Pennsylvania, and employs more than 7,000 employees at approximately 50 manufacturing facilities throughout North America. Continuing the 100-year commitment of "quality made certain, satisfaction guaranteed," CertainTeed remains one of the most trusted names in the industry. More information is available at www.certainteed.com.

This document is available in Spanish. Call 1-800-782-8777. (Note: The operators do not speak Spanish.) Se puede obtener este documento en español. Favor de llamar 1-800-782-8777. (Los operadores no hablan español.)

Consulter les informations relatives à la garantie sur le site www.certainteed.com.

Effective on shingles installed on or after May 15, 2008.

ASK ABOUT OUR OTHER CERTAINTEED PRODUCTS AND SYSTEMS:

EXTERIOR: ROOFING • SIDING • WINDOWS • FENCE • RAILING • TRIM • DECKING • FOUNDATIONS • PIPE
INTERIOR: INSULATION • WALLS • CEILINGS

CertainTeed Corporation
P.O. Box 860
Valley Forge, PA 19482

Professional: 800-233-8990
Consumer: 800-782-8777
www.certainteed.com

CertainTeed 

CertainTeed

2009 Limited Warranty

Asphalt Shingle Products



CertainTeed 

Quality made certain. Satisfaction guaranteed.™

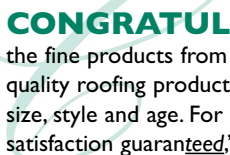

CONGRATULATIONS! ... and thank you for your recent purchase of one of the fine products from CertainTeed Roofing. Since 1904, CertainTeed has been producing quality roofing products that provide long-lasting beauty and protection for homes of every size, style and age. For over 100 years, the basis for our name, “Quality made certain, satisfaction guaranteed,” has been our ongoing philosophy.

Your CertainTeed roofing warranty fully explains how CertainTeed supports its products with the strongest warranty protection available. It is important that you read the warranty section of this brochure. The warranty lists the specific CertainTeed asphalt shingle products that are covered and the period of time for which they are covered. Take the time to understand how CertainTeed protects your purchase by standing behind our products.

SURESTART™ PROTECTION

Because CertainTeed roofing products are manufactured to the highest quality standards, we confidently include the additional assurance of SureStart™ protection with all CertainTeed shingles. SureStart provides the strongest protection you can get in the vital early years of your new roof.

Simply put, if a manufacturing defect is discovered during the SureStart period, CertainTeed will provide reimbursement of 100% of the reasonable cost of the shingles and labor to repair the defective shingles or apply new shingles to replace the defective shingles (exclusive of costs of tear-off, metal work and disposal). SureStart protection begins on the date of application and is not prorated or otherwise reduced during the SureStart period.

See page 3 – SureStart Protection – for further details. SureStart protection does not extend to any shingles applied to any non-ventilated or inadequately ventilated roof deck systems, except as stated on pages 5 and 6.

TRANSFERABILITY

The warranty for CertainTeed shingles is transferable by the original property owner/consumer to the first subsequent owner. If transferred during the product's SureStart period, the warranty for the new owner is the same as it would have been for the original owner, except for products with lifetime warranty periods where the duration of the transferred warranty will be 50 years measured from the beginning of the SureStart period. If the warranty is transferred after the SureStart period has elapsed, the duration of the transferred warranty is limited to no more than **two** years from the date of real estate title transfer. See pages 4 and 5 – Transferability and Transfers During/After the SureStart Period – for further details.

LIMITED, PRORATED AND TRANSFERABLE WARRANTY

This warranty covers asphalt shingle products listed in Table 1, sold only in the United States of America, its territories and Canada.

What and Who Is Covered and for How Long

CertainTeed warrants to the original property owner/consumer that, when subject to normal and proper use, its shingles will be free from manufacturing defects for the length of time specified in Table 1 and that CertainTeed will pay to repair, replace or clean, at its option, any shingles CertainTeed determines are defective under the terms of this Limited Warranty. In the event of repair, replacement or cleaning pursuant to the terms of this Limited Warranty, the warranty applicable to the original shingles shall apply to the repaired, replaced or cleaned shingles and will extend for the balance of the original warranty period.

The Lifetime warranty period offered for certain shingles in Table 1 is only available to individual homeowners. The warranty period for shingles installed on premises not used by individual homeowners as their residence is limited to 50 years following the installation of the shingles. All other structures and property owners (e.g. corporations, governmental agencies, partnerships, trusts, religious organizations, schools, condominiums, homeowner associations or cooperative housing arrangements, apartment buildings, and any other type of building or premises not owned by individual homeowners) are limited to a 50-year warranty period.

SureStart™ Protection

All of CertainTeed's shingle products are covered by SureStart protection. Under this warranty feature, CertainTeed, at no charge, will pay to repair or replace, at its option, any shingles CertainTeed determines are defective during the SureStart period. Note: Wind warranty and algae warranty are covered separately as described on page 6. The SureStart period begins on the date of application and terminates following the period specified in Table 1. CertainTeed's maximum liability under SureStart is equal to the reasonable cost of shingles and labor to replace or repair the defective shingles. Roof tear-off, metal work, flashing and disposal expenses, and other costs or expenses incurred during such repair or replacement are not covered or reimbursed by this Limited Warranty, except for products with lifetime warranty periods, for which CertainTeed's maximum liability also includes the cost of roof tear-off and disposal.

SureStart protection does not extend to any shingles applied to non-ventilated or inadequately ventilated roof deck systems as determined by CertainTeed, except as stated on page 5. CertainTeed's maximum contribution toward the cost of repairing or replacing defective shingles applied to a non-ventilated or inadequately ventilated roof deck system is calculated using the Maximum Material Liability After SureStart Period figure specified in Table 1, less 1/120th of that amount times the number of months from the start of the warranty period to the date when CertainTeed determines the shingles are defective. Labor costs, roof tear-off, metal work, flashing and disposal expenses, and other costs or expenses incurred during such repair or replacement are not covered or reimbursed by this Limited Warranty.

In instances in which CertainTeed, under the terms of this warranty, has agreed to pay the cost of labor required to repair or replace defective shingles, CertainTeed will provide reimbursement only upon receipt of a copy of the contractor's invoice or other written evidence of the completion of such work which CertainTeed, in its sole discretion, deems acceptable.

TABLE 1

Product	Warranty Period	SureStart™ Period	Wind Warranty MPH	Algae Resistant Warranty Period**	Maximum Material Liability After SureStart Period	Reduction Figure Per Month
GRAND MANOR™	LIFETIME	10 YEARS	110	15	\$140/Square	1/600*
CENTENNIAL SLATE™	LIFETIME	10 YEARS	110	15	\$130/Square	1/600*
CARRIAGE HOUSE™	LIFETIME	10 YEARS	110	15	\$110/Square	1/600*
PRESIDENTIAL SHAKE™ TL (& AR)	LIFETIME	10 YEARS	110	15	\$140/Square	1/600*
LANDMARK™ TL (& AR) (& IMPACT RESISTANT)***	LIFETIME	10 YEARS	110††	15	\$120/Square	1/600*
PRESIDENTIAL SHAKE™ (& AR) (& IMPACT RESISTANT)***	LIFETIME	10 YEARS	110	15	\$95/Square	1/600*
LANDMARK™ PREMIUM/ARCHITECT 80 (& AR)	LIFETIME	10 YEARS	90††	10xxx	\$55/Square	1/600*
LANDMARK™ WOODSCAPE PREMIUM	LIFETIME	10 YEARS	90††	10	\$55/Square	1/600*
LANDMARK™ SOLARIS	LIFETIME	10 YEARS	90††	N/A	\$55/Square	1/600*
INDEPENDENCE™ (& AR)	LIFETIME	5 YEARS	110	10	\$55/Square	1/600*
LANDMARK™ SPECIAL	50 YEARS	5 YEARS	90††	10	\$55/Square	1/600
HATTERAS®	40 YEARS	5 YEARS	110	10	\$55/Square	1/480
LANDMARK™ PLUS (& AR)	40 YEARS	5 YEARS	80††	10	\$45/Square	1/480
LANDMARK™ CANADA AR	40 YEARS	5 YEARS	80††	10	\$45/Square	1/480
XT™ 30 (& AR) (& IMPACT RESISTANT)***	30 YEARS	5 YEARS	70†††	10	\$35/Square	1/360
LANDMARK™ (& AR)	30 YEARS	5 YEARS	70††	10	\$40/Square	1/360
LANDMARK™ WOODSCAPE AR	30 YEARS	5 YEARS	70††	10	\$40/Square	1/360
CLASSIC HORIZON™ (& AR)	30 YEARS	5 YEARS	70	10	\$40/Square	1/360
NEW HORIZON™	30 YEARS	5 YEARS	70	N/A	\$40/Square	1/360
XT™ 25 (& AR)	25 YEARS	5 YEARS	60	10	\$30/Square	1/300
CT 20 (& AR)	20 YEARS	3 YEARS	60	10	\$25/Square	1/240
ANY SHINGLES APPLIED TO ANY INADEQUATELY VENTILATED ROOF DECK	10 YEARS†	N/A	N/A	N/A	See Above	1/120

“The Lifetime Warranty period is only available to individual homeowners. The warranty period for shingles installed on premises not used by individual homeowners as their residence is limited to 50 years following the installation of the shingles. All other structures and property owners (e.g., corporations, governmental agencies, partnerships, trusts, religious organizations, schools, condominiums, homeowner associations or cooperative housing arrangements, apartment buildings, and any other type of building or premises not owned by individual homeowners) and Limited Warranty transferees are limited to a 50-year warranty period.”

** For Grand Manor, Centennial Slate, Carriage House, Presidential Shake TL, Landmark TL, Landmark TL (Impact Resistant), Presidential Shake, Presidential Shake (Impact Resistant), Landmark Solaris, Landmark Premium, Landmark Woodscape Premium and Independence, at the completion of the 40th year the reduction figure will remain at 480/600, or 20% of the total maximum liability.*

*** Algae Resistant Warranty period is only for the Algae Resistant (AR) version of the pertinent shingle.*

xxx Algae Resistant Warranty for this product is 15 years in Hawaii.

**** CertainTeed warrants that its Landmark TL (Impact Resistant), Landmark Special, Presidential Shake (Impact Resistant) and XT 30 (Impact Resistant) shingles comply with UL 2218 Impact Resistance of Prepared Roof Covering Materials test criteria at time of manufacture.*

† For details of warranty coverage for shingles installed on inadequately ventilated roof decks on both residential and commercial buildings, see provisions under “Inadequately Ventilated and Non-Ventilated Decks.”

†† Wind warranty upgrade – Landmark Canada, Landmark Premium, Landmark Special, Landmark Plus, Landmark Solaris, Landmark TL and Landmark Woodscape Premium roof shingles are warranted to resist blow-off due to wind velocities, including gusts, up to a maximum of 130 miles per hour during the first ten (10) years; Landmark and Landmark Woodscape roof shingles are warranted to resist blow-off due to wind velocities, including gusts, up to a maximum of 110 mph during the first five (5) years of the warranty, provided all of the following conditions are met:

- The CertainTeed shingles are not applied over existing roof shingles (roof-overs are not permitted).*
- CertainTeed Swiftstart starter shingles are installed along the roof eaves and rakes (Note: For the CertainTeed Northeast Region, Universal 7-inch starter shingles can be installed in place of Swiftstart as indicated for all named products except Landmark Special, Landmark Solaris, and Landmark TL).*
- CertainTeed Shadow Ridge™ or Mountain Ridge™ hip and ridge accessory products are installed as cap shingles.*

††† Wind warranty for XT 30 (E AR) (E Impact Resistant) for the Northwest region is 80 mph. Wind warranty is 100 mph in Hawaii and Alaska only.

Flintlastic™ SA (Self-Adhering) System

For low slope residential roofing projects with less than 20 squares, CertainTeed offers a 12-year SureStart membrane warranty on its two-ply system consisting of a Flintlastic SA Nail Base and a Flintlastic SA Cap sheet, provided the system was applied in accordance with CertainTeed’s current installation instructions published at the time of installation.

CertainTeed warrants the roof membrane, subject to the following terms, conditions, limitations, and exclusions, for a period of 12 years from the date of installation: If a manufacturing defect in the roof membrane causes a leak, CertainTeed or its designated roofing contractor will, at CertainTeed’s expense, repair the roof membrane as necessary to restore it to a watertight condition. Only manufacturing defects in the roof membrane that cause leaks are covered by this warranty. Roof membrane, as used herein, shall include the following components: a base sheet and a cap sheet. The roof components which are not part of the roof membrane and hence NOT covered by this warranty are the following: underlying roof deck, insulation, vapor retarders, fasteners, metal work, drains, skylights, vents, plastic accessories, all types of flashing, decorative or reflective coating, surfacing and/or any ballast, rock or gravel. In no event, however, will CertainTeed be responsible for any costs related to the removal or abatement of any asbestos present in any existing roof system to which the CertainTeed roof membrane is applied.

Beyond SureStart Protection

If CertainTeed determines its shingles are defective after the SureStart period, CertainTeed’s maximum contribution toward the cost of repairing or replacing defective shingles will be calculated using the Maximum Material Liability After SureStart Period figure specified in Table 1, less the Reduction Figure Per Month from the start of the warranty period to the date when CertainTeed determines the shingles are defective. Labor costs, roof tear-off, metal work, flashing and disposal expenses, and other costs or expenses incurred during such repair or replacement are not covered or reimbursed by this Limited Warranty.

Transferability

This Limited Warranty is transferable, but only by the original property owner/consumer to one subsequent property owner. After the Limited Warranty has been transferred once, it is no longer transferable. The warranty transfer is only effective if the subsequent property owner provides written notice of the transfer to CertainTeed within sixty (60) days from the real estate title transfer date. (Notice must be sent to CertainTeed Roofing Technical Services Department, 1400 Union Meeting Road, Blue Bell, PA 19422).

Transfers During the SureStart Period

If this Limited Warranty is transferred during the product's SureStart period, the warranty for the new owner is the same as it would have been for the original owner, except for products with lifetime warranty periods where the duration of the transferred warranty will be 50 years measured from the beginning of the SureStart period (i.e. the date of installation), and the remaining period of SureStart protection will be available to the subsequent property owner.

Transfers After the SureStart Period

If this Limited Warranty is transferred by the original property owner/consumer after the SureStart period, the warranty following the transfer will be limited to two (2) years from the date of real estate title transfer. The warranty obligation will be calculated as explained in the section above titled "Beyond SureStart Protection."

Limitations

This Limited Warranty does not provide protection against and CertainTeed will have no liability for any failure, defect or damage caused by situations and events beyond normal exposure conditions, including but not limited to:

- Winds, including gusts, greater than the Wind Warranty figures in Table 1, lightning, hurricanes, tornado, hailstorm, earthquake, fire, explosion, flood or falling objects.
- Distortion, cracking or other failure or movement of the base material over which the shingles are applied, of the roof deck, or of the walls or foundation of the building itself.
- Damage caused by structural changes, alterations or additions, or by the installation of equipment (such as, but not limited to, aerials, signs or air-conditioning equipment) to the structure after the original shingles have been applied.
- Shading, stains or discoloration to the shingles arising from outside sources such as but not limited to algae (unless blue-green algae as described in the section titled "Limited Algae Warranty"), fungus, moss, lichens or other vegetation, mold or mildew growth, or paints, chemicals or other similar materials.
- Misuse, abuse, neglect, or improper transportation, handling or storage of the shingles.
- Installation of the shingles over non-approved roof decks as more fully explained in CertainTeed's installation instructions.
- Damage caused by improper installation or installation not in accordance with CertainTeed's installation instructions published at the time of original installation.
- Damage to the shingles, the roof deck or the structure caused by ice backup or ice damming.
- Vandalism or acts of war.
- Any other cause not a result of a manufacturing defect in the shingles.

Mold and mildew are functions of environmental conditions and are not manufacturing defects. As such, mold and mildew are not covered by this Limited Warranty or any implied warranty.

CertainTeed reserves the right to discontinue or modify any of its products, including the color of its shingles, and shall not be liable as a result of such discontinuance or modification, nor shall CertainTeed be liable in the event replacement material varies in color in comparison to the original product as a result of normal weathering. If CertainTeed replaces any material under this warranty, it may substitute products designated by CertainTeed to be of comparable quality or price range in the event the product initially installed has been discontinued or modified.

Inadequately Ventilated and Non-Ventilated Decks

Any shingles applied to inadequately ventilated or non-ventilated decks, other than the shingles and deck systems described in the section titled "Insulated Decks and Radiant Barriers," are subject to a reduced limited warranty period of ten (10) years and do not qualify for SureStart protection. SureStart protection and the Warranty Period applicable to the shingle are available if CertainTeed determines that the shingle damage was caused exclusively by a manufacturing defect that is unrelated to the inadequate roof system ventilation.

Insulated Decks and Radiant Barriers

CertainTeed's Limited Warranty, including SureStart Protection, will remain in force when its fiber glass shingles are applied to roof deck assemblies where foam insulation is prefabricated into the roof deck system

(often called “nailboard insulation”), where insulation is installed beneath an acceptable roof deck system, or where radiant barriers are installed, with or without ventilation, directly below the deck. Acceptable roof deck surfaces must consist of at least 3/8" thick plywood or 7/16" thick Oriented Strand Board (OSB) and slopes must be greater than 2:12. If a different deck surface material will be utilized, please contact CertainTeed’s Technical Services Department for assistance. (See the following [important restrictions](#).)

The design professional is responsible for ensuring 1) proper quality and application of the insulation and/or radiant barrier, 2) provision of adequate structural ventilation and/or vapor retarders as determined to be necessary, and 3) that all local codes are met (particularly taking into account local climate conditions). Special attention must be taken if cellular foam, fiber glass, cellulose insulation or other highly permeable insulation will be used in an unventilated system, or if the insulation/rafter or insulation/joist planes may create an air leak that could lead to moisture transmission and condensation problems. All these important factors and decisions, while not the responsibility of CertainTeed, are critical to assure proper deck system performance.

Ventilated Nail-Base Roof Insulation

Ventilated Nail-Base Roof Insulation products (e.g. Flint Board™ CV) are made of rigid insulation (typically foam board) and another layer of material that provides air space above the insulation and below the nailable deck (which is typically at least 7/16" thick OSB or 3/8" thick plywood). These products can provide soffit-to-ridge ventilation, and if installed in accordance with the deck manufacturer’s instructions to achieve sufficient ventilation, will not reduce the scope or length of CertainTeed’s Limited Warranty coverage.

Limited Algae Warranty

Blue-green algae, which is commonly but incorrectly called “fungus,” can create unsightly streaking on shingles. CertainTeed warrants that the Algae-Resistant (AR) versions of Grand Manor™, Centennial Slate™, Carriage House™, Presidential Shake™ TL, Landmark™ TL, and Presidential Shake™ shingles will remain free from blue-green algae growth (but not mold or mildew growth) which adversely affects the overall appearance of said shingles for a period of fifteen (15) years, and that Independence™, Hatteras®, Landmark™ Premium, Landmark™ Woodscape Premium, Landmark™ Plus, Landmark™ Special, Landmark™, Landmark™ Woodscape, Classic Horizon, XT™ 30, XT™ 25 and CT 20 shingles will remain free from blue-green algae growth (but not mold or mildew growth) which adversely affects the overall appearance of said shingles for a period of ten (10) years. If during the Algae-Resistant Warranty Period specified in Table 1, the overall appearance of the Algae-Resistant shingles is adversely affected by blue-green algae, CertainTeed will pay the reasonable cost to replace or clean at its option, any affected shingles. In the event of replacement or cleaning, for the remainder of the Algae-Resistant Warranty Period, CertainTeed’s maximum contribution towards subsequent replacement or cleaning will be calculated using the Algae-Resistant Warranty Period specified in Table 1, less a prorated adjustment that reflects the number of months that have elapsed from the start of the Algae-Resistant Warranty Period to the date of reoccurrence.

WARNING: FOR LOW-VOLUME RAIN AND SALT FOG AREAS

In areas of low-volume rain (e.g. areas that receive insignificant rainfall during a 90-day period) and/or “salt fog” (e.g. parts of the Southern California coastline), copper released by algae-resistant (AR) granules or shingles can react with aluminum in gutters and cause severe corrosion of the gutters. In such regions, CertainTeed strongly recommends that vinyl or copper gutters, not aluminum gutters, be used with algae-resistant shingles. **CertainTeed disclaims all liability and responsibility for any damages that may result from the use of its algae-resistant shingle products with copper granules where gutters containing aluminum are used.**

Limited Wind Warranty

CertainTeed warrants its shingles will resist blow-off damage due to wind velocities, including gusts and hurricane winds up to the maximum wind velocity per the Wind Velocity speeds specified in Table 1 during the first ten (10) years of the warranty for Grand Manor™, Centennial Slate™, Carriage House™, Presidential Shake™ TL, Landmark™ TL, Presidential Shake™, Hatteras®, Landmark™ Premium, Landmark™ Woodscape Premium, and Landmark™ Solaris, and during the first five (5) years of the warranty for all other CertainTeed shingle products listed in Table 1 (the “Wind Warranty Period”).

CertainTeed’s obligations and liability for shingle blow-off damage during the Wind Warranty period are limited as follows:

- If shingles blow off because the shingle's self-sealing asphalt strips did not activate, CertainTeed will have no liability or warranty obligation unless CertainTeed is afforded the opportunity to hand seal, at its expense, any non-sealing shingles.
- If shingles blow off even though the shingle's self-sealing asphalt strips did activate, CertainTeed will furnish replacement shingles without charge, but only for damaged or blown off shingles. CertainTeed will not be responsible for or reimburse labor costs or any other costs pertaining to removal or replacement of damaged shingles. Any costs in excess of CertainTeed's material contribution are the property owner's responsibility (and may be covered by homeowner's insurance).
- CertainTeed shall have no liability for any shingles not fastened in accordance with CertainTeed application instructions.
- CertainTeed shall have no liability for any damage to persons or property caused by blown off shingles.
- CertainTeed's maximum liability during the Wind Warranty period is the reasonable cost of hand sealing all of the shingles on the roof.

What the Customer Must Do

If you believe your shingles have a manufacturing defect, you must promptly notify CertainTeed and provide proof of property ownership and the date of shingle purchase and application. Unless you provide such proof, CertainTeed will use the date of manufacture to calculate the start of the warranty period. In order to properly evaluate and process a warranty claim, CertainTeed may require the property owner to submit a shingle sample to CertainTeed for analysis and/or permit a CertainTeed representative to make repairs to, take photographs of, and/or take samples from the roof, if required. CertainTeed will evaluate each properly reported claim and will repair, replace, clean or reimburse the property owner for the shingles it determines are defective, in accordance with the terms of this Limited Warranty within a reasonable amount of time. For more details about submitting a warranty claim, visit www.ctroof.com or call (800) 345-1145.

**Please send all notifications and correspondence to:
 CertainTeed Corporation, 1400 Union Meeting Road, Blue Bell, PA 19422,
 Attn: CertainTeed Roofing Technical Services Department. Telephone number: 800-345-1145.**

Warranty Registration (not required)

You may register your product warranty on CertainTeed's website: www.certainteed.com/warrantyreg. Each registrant receives a registration confirmation number by return e-mail that can be printed and kept with this Limited Warranty and your proof of purchase. If you do not have internet access, you can register your shingles by sending: (1) your name, address, and telephone number; (2) the name and contact information of the contractor who installed your shingles and the original date of installation; and, (3) the type, color and number of squares of your shingles to:

**CertainTeed Corporation, 1400 Union Meeting Road, Blue Bell, PA 19422,
 Attn: CertainTeed Roofing Technical Services Department.**

CertainTeed will register your information and mail you a confirmation number. Failure to register this warranty does NOT void the warranty or any of its terms.

FOR YOUR RECORDS

Product Purchased: _____ Date of Installation: _____
 Roofing Contractor: _____ Contractor's Telephone No. _____

This warranty applies to shingles installed during the calendar year of 2009.
 (The warranty in effect at the time the material is originally installed is the applicable warranty.)

Limited Warranty and Limitation of Remedies

THIS DOCUMENT CONSTITUTES THE EXCLUSIVE WARRANTIES AND REMEDIES PROVIDED BY CERTAINTEED. THE WARRANTIES AND REMEDIES CONTAINED IN THIS DOCUMENT ARE EXPRESSLY IN LIEU OF ANY AND ALL OTHER OBLIGATIONS, GUARANTEES AND WARRANTIES, WHETHER WRITTEN, ORAL OR IMPLIED BY STATUTE OR AT LAW. STATE OR PROVINCIAL LAW WILL DETERMINE THE PERIOD OF TIME FOLLOWING THE SALE THAT A PROPERTY OWNER MAY SEEK A REMEDY UNDER THE IMPLIED WARRANTY OF MERCHANTABILITY OR FITNESS FOR A PARTICULAR PURPOSE. CERTAINTEED'S OBLIGATIONS, RESPONSIBILITIES, AND LIABILITY SHALL BE LIMITED TO REPAIRING OR REPLACING THE DEFECTIVE PRODUCT OR CLEANING ALGAE-RESISTANT SHINGLES IN THE CASE OF ALGAE GROWTH AS SET FORTH

IN THIS LIMITED WARRANTY. IN NO EVENT SHALL CERTAINTEED BE LIABLE FOR ANY SPECIAL, INDIRECT, INCIDENTAL OR CONSEQUENTIAL DAMAGES OF ANY KIND, INCLUDING ANY DAMAGE TO THE PROPERTY, THE BUILDING OR ITS CONTENTS, OR FOR INJURY TO ANY PERSONS, THAT MAY OCCUR AS A RESULT OF THE USE OF CERTAINTEED'S PRODUCTS OR AS A RESULT OF THE BREACH OF THIS WARRANTY. IF YOUR STATE OR PROVINCE DOES NOT ALLOW EXCLUSIONS OR LIMITATIONS OF SPECIAL, INDIRECT, INCIDENTAL OR CONSEQUENTIAL DAMAGES, THE ABOVE LIMITATIONS MAY NOT APPLY TO YOU.

IN NO EVENT SHALL CERTAINTEED'S TOTAL LIABILITY ARISING OUT OF OR RELATED TO THE PRODUCT(S) OR THIS WARRANTY EXCEED THE ORIGINAL PURCHASE PRICE OF THE PRODUCTS AND THE LABOR COSTS RELATING TO THE ORIGINAL INSTALLATION OF SUCH PRODUCTS.

This Limited Warranty may not be modified, altered or expanded by anyone, including product distributors, dealers, sellers and/or CertainTeed field representatives.

This Limited Warranty gives you specific legal rights, and you may also have other rights which vary from State to State, or Province to Province.

ROOFING PLANTS AND REGIONAL SALES OFFICES

CertainTeed roofing products are sold by CertainTeed Roofing in eight sales regions. They are manufactured in ten residential roofing plants and one commercial roofing plant.

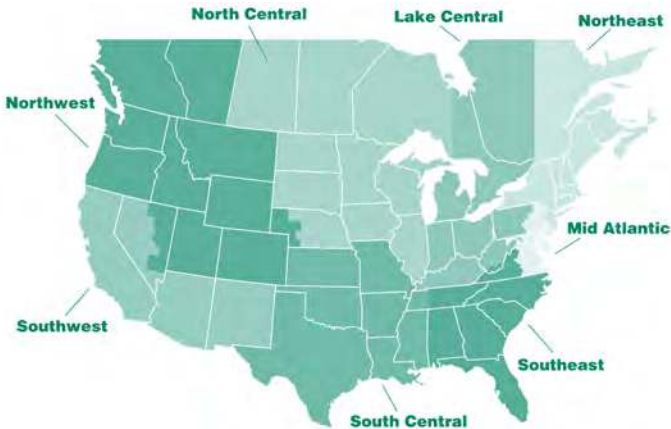

Since the early 1900s, CertainTeed Corporation has been an innovator in the building materials industry and today is a leading manufacturer of building materials including residential and commercial roofing, vinyl and fiber cement siding, vinyl windows, composite decking and railing, fiber glass insulation, vinyl fence, and piping products. The company is headquartered in Valley Forge, Pennsylvania, and employs more than 7,000 employees at approximately 50 manufacturing facilities throughout North America. Continuing the 100-year commitment of "quality made certain, satisfaction guaranteed," CertainTeed remains one of the most trusted names in the industry. More information is available at www.certainteed.com.

This document is also available in Spanish and French. Call 1-800-782-8777 or go to www.certainteed.com. (Note: The operators do not speak Spanish or French.)

Se puede obtener este documento en español. Favor de llamar 1-800-782-8777. (Los operadores no hablan español.)

Ce document est disponible en anglais et en espagnol. Composez le 1-800-782-8777. (Remarque: Les préposés ne parlent ni l'espagnol ni le français.)

ASK ABOUT OUR OTHER CERTAINTEED PRODUCTS AND SYSTEMS:

EXTERIOR: ROOFING • SIDING • WINDOWS • FENCE • RAILING • TRIM • DECKING • FOUNDATIONS • PIPE

INTERIOR: INSULATION • GYPSUM • CEILINGS

CertainTeed Corporation
P.O. Box 860
Valley Forge, PA 19482

Professional: 800-233-8990
Consumer: 800-782-8777
www.certainteed.com

CertainTeed 

CertainTeed

2010 Limited Warranty

Asphalt Shingle Products



CertainTeed 

Quality made certain. Satisfaction guaranteed.™



CONGRATULATIONS!... and thank you for your recent purchase of one of the fine products from CertainTeed Roofing. Since 1904, CertainTeed has been producing quality roofing products that provide long-lasting beauty and protection for homes of every size, style and age. For over 100 years, the basis for our name, “Quality made certain, satisfaction guaranteed,” has been our ongoing philosophy.

Your CertainTeed roofing warranty fully explains how CertainTeed supports its products with the strongest warranty protection available. It is important that you read the warranty section of this brochure. The warranty lists the specific CertainTeed asphalt shingle products that are covered and the period of time for which they are covered. Take the time to understand how CertainTeed protects your purchase by standing behind our products.

SURESTART™ PROTECTION

Because CertainTeed roofing products are manufactured to the highest quality standards, we confidently include the additional assurance of SureStart™ protection with all CertainTeed shingles. SureStart provides the strongest protection you can get in the vital early years of your new roof.

Simply put, if a manufacturing defect is discovered during the SureStart period, CertainTeed will provide reimbursement of 100% of the reasonable cost of the shingles and labor to repair the defective shingles or apply new shingles to replace the defective shingles (exclusive of costs of tear-off, metal work and disposal). SureStart protection begins on the date of application and is not prorated or otherwise reduced during the SureStart period. See below – “SureStart Protection” – for further details. SureStart protection does not extend to any shingles applied to any non-ventilated or inadequately ventilated roof deck systems, except as stated on page 5.

TRANSFERABILITY

The warranty for CertainTeed shingles is transferable by the original property owner/consumer to the first subsequent owner. If transferred during the product’s SureStart period, the warranty for the new owner is the same as it would have been for the original owner, except for products with lifetime warranty periods where the duration of the transferred warranty will be 50 years measured from the beginning of the SureStart period. If the warranty is transferred after the SureStart period has elapsed, the duration of the transferred warranty is limited to no more than **two** years from the date of real estate title transfer. See pages 4 and 5 – “Transferability” and “Transfers During/After the SureStart Period” – for further details.

LIMITED, PRORATED AND TRANSFERABLE WARRANTY

This warranty covers asphalt shingle products listed in Table 1, sold only in the United States of America, its territories and Canada.

What and Who Is Covered and for How Long

CertainTeed warrants to the original property owner/consumer that, when subject to normal and proper use, its shingles will be free from manufacturing defects for the length of time specified in Table 1 and that CertainTeed will pay to repair, replace or clean, at its option, any shingles CertainTeed determines are defective under the terms of this Limited Warranty. In the event of repair, replacement or cleaning pursuant to the terms of this Limited Warranty, the warranty applicable to the original shingles shall apply to the repaired, replaced or cleaned shingles and will extend for the balance of the original warranty period.

The Lifetime warranty period offered for certain shingles in Table 1 is only available to individual homeowners. The warranty period for shingles installed on premises not used by individual homeowners as their residence is limited to 50 years following the installation of the shingles. All other structures and property owners (e.g. corporations, governmental agencies, partnerships, trusts, religious organizations, schools, condominiums, homeowner associations or cooperative housing arrangements, apartment buildings, and any other type of building or premises not owned by individual homeowners) are limited to a 50-year warranty period.

SureStart™ Protection

All of CertainTeed’s shingle products are covered by SureStart protection. Under this warranty feature, CertainTeed, at no charge, will pay to repair or replace, at its option, any shingles CertainTeed determines are defective during the SureStart period. Note: Wind warranty and algae warranty are covered separately as described

on page 6. The SureStart period begins on the date of application and terminates following the period specified in Table 1. CertainTeed's maximum liability under SureStart is equal to the reasonable cost of shingles and labor to replace or repair the defective shingles. Roof tear-off, metal work, flashing and disposal expenses, and other costs or expenses incurred during such repair or replacement are not covered or reimbursed by this Limited Warranty, except for products with Lifetime warranty periods, for which CertainTeed's maximum liability also includes the cost of roof tear-off and disposal.

SureStart protection does not extend to any shingles applied to non-ventilated or inadequately ventilated roof deck systems as determined by CertainTeed, except as stated on page 5. CertainTeed's maximum contribution toward the cost of repairing or replacing defective shingles applied to a non-ventilated or inadequately ventilated roof deck system is calculated using the Maximum Material Liability After SureStart Period figure specified in Table 1, less 1/120th of that amount multiplied by the number of months from the start of the warranty period to the date when CertainTeed determines the shingles are defective. Labor costs, roof tear-off, metal work, flashing and disposal expenses, and other costs or expenses incurred during such repair or replacement are not covered or reimbursed by this Limited Warranty.

In instances in which CertainTeed, under the terms of this warranty, has agreed to pay the reasonable cost of labor required to repair or replace defective shingles, CertainTeed will provide reimbursement only upon receipt of a copy of the contractor's invoice or other written evidence of the completion of such work which CertainTeed, in its sole discretion, deems acceptable.

TABLE 1

Product	Warranty Period	SureStart™ Period	Wind Warranty MPH	Algae Resistant Warranty Period**	Maximum Material Liability After SureStart Period	Reduction Figure Per Month
GRAND MANOR™	LIFETIME ^a	10 YEARS	110	15	\$140/Square	1/600*
CENTENNIAL SLATE™	LIFETIME ^a	10 YEARS	110	15	\$130/Square	1/600*
GARRIAGE HOUSE™	LIFETIME ^a	10 YEARS	110	15	\$110/Square	1/600*
PRESIDENTIAL SHAKE™ TL (& AR)	LIFETIME ^a	10 YEARS	110	15	\$140/Square	1/600*
LANDMARK™ TL (& AR) (& IMPACT RESISTANT)***	LIFETIME ^a	10 YEARS	110††	15	\$120/Square	1/600*
PRESIDENTIAL SHAKE™ (& AR) (& IMPACT RESISTANT)***	LIFETIME ^a	10 YEARS	110	15	\$95/Square	1/600*
LANDMARK™ PREMIUM/ARCHITECT 80 (& AR)	LIFETIME ^a	10 YEARS	90††	10xxv	\$55/Square	1/600*
LANDMARK™ WOODSCAPE PREMIUM	LIFETIME ^a	10 YEARS	90††	10	\$55/Square	1/600*
LANDMARK SOLARIS™	LIFETIME ^a	10 YEARS	90††	10xxv	\$55/Square	1/600*
INDEPENDENCE™ (& AR)	LIFETIME ^a	5 YEARS	110	10	\$55/Square	1/600*
LANDMARK™ SPECIAL	50 YEARS	5 YEARS	90††	10	\$55/Square	1/600
HATTERAS®	40 YEARS	10 YEARS	110	10	\$55/Square	1/480
LANDMARK™ PLUS (& AR)	40 YEARS	7 YEARS	80††	10	\$45/Square	1/480
LANDMARK™ CANADA AR	40 YEARS	5 YEARS	80††	10	\$45/Square	1/480
XT™ 30 (& AR) (& IMPACT RESISTANT)***	30 YEARS	5 YEARS	70†††	10	\$35/Square	1/360
LANDMARK™ (& AR)	30 YEARS	5 YEARS	70††	10	\$40/Square	1/360
LANDMARK™ WOODSCAPE	30 YEARS	5 YEARS	70††	10	\$40/Square	1/360
XT™ 25 (& AR)	25 YEARS	5 YEARS	60	10	\$30/Square	1/300
CT 20	20 YEARS	3 YEARS	60	10	\$25/Square	1/240
ANY SHINGLES APPLIED TO ANY INADEQUATELY VENTILATED ROOF DECK	10 YEARS†	N/A	N/A	N/A	See Above	1/120

^aThe Lifetime Warranty period is only available to individual homeowners. The warranty period for shingles installed on premises not used by individual homeowners as their residence is limited to 50 years following the installation of the shingles. All other structures and property owners (e.g., corporations, governmental agencies, partnerships, trusts, religious organizations, schools, condominiums, homeowner associations or cooperative housing arrangements, apartment buildings, and any other type of building or premises not owned by individual homeowners) and Limited Warranty transferees are limited to a 50-year warranty period.

* For Grand Manor, Centennial Slate, Carriage House, Presidential Shake TL, Landmark TL, Landmark TL (Impact Resistant and AR), Presidential Shake, Presidential Shake (Impact Resistant and AR), Landmark Solaris, Landmark Premium, Landmark Woodscape Premium and Independence, at the completion of the 40th year the reduction figure will remain at 480/600, or 20% of the total maximum liability.

** Algae Resistant Warranty period is only for the Algae Resistant (AR) version of the pertinent shingle.

xxx Algae Resistant Warranty for this product is 15 years in Hawaii.

*** CertainTeed warrants that its Landmark TL (Impact Resistant), Landmark Special, Presidential Shake (Impact Resistant) and XT 30 (Impact Resistant) shingles comply with UL 2218 Impact Resistance of Prepared Roof Covering Materials test criteria at time of manufacture.

† For details of warranty coverage for shingles installed on inadequately ventilated roof decks on both residential and commercial buildings, see provisions under "Inadequately Ventilated and Non-Ventilated Decks."

†† Wind warranty upgrade – Landmark Canada, Landmark Premium, Landmark Special, Landmark Plus, Landmark Solaris, Landmark TL and Landmark Woodscape Premium roof shingles are warranted to resist blow-off due to wind velocities, including gusts, up to a maximum of 130 miles per hour during the first ten (10) years; Landmark (and AR) and Landmark Woodscape roof shingles are warranted to resist blow-off due to wind velocities, including gusts, up to a maximum of 110 mph during the first five (5) years of the warranty, provided all of the following conditions are met:

- The CertainTeed shingles are not applied over existing roof shingles (roof-overs are not permitted).
- CertainTeed Swiftstart starter shingles are installed along the roof eaves and rakes (Note: In Florida, CertainTeed will waive the requirement of applying Swiftstart starter shingles along the roof rake if all of the following conditions are met. The applicable building code requires that asphalt roof shingles be embedded in an 8-inch-wide bed of asphalt roofing cement applied along the roof rake edges. **And**, the Landmark Series shingles are installed and embedded in an 8-inch-wide bed of asphalt roofing cement along the roof rake edges in accordance with the code. In the CertainTeed Northeast Region, Universal 7-inch starter shingles can be installed in place of Swiftstart as indicated for all named products except Landmark Special, Landmark Solaris, and Landmark TL).
- CertainTeed Shadow Ridge™ or Mountain Ridge™ hip and ridge accessory products are installed as cap shingles.

††† Wind warranty for XT 30 (® AR) (® Impact Resistant) for the Northwest region is 80 mph.

Wind warranty is 100 mph in Hawaii and Alaska only.

Flintlastic™ SA (Self-Adhering) System

For low slope residential roofing projects less than 2000 square feet (20 squares), CertainTeed offers a limited roof membrane warranty as follows: A 10-year warranty duration on a single ply of Flintlastic SA Cap sheet over a primed plywood roof deck or a 12-year warranty duration for a two-ply system consisting of a Flintlastic SA Nail Base and a Flintlastic SA Cap sheet, provided the Flintlastic products were applied in accordance with CertainTeed's current installation instructions published at the time of installation.

CertainTeed warrants the *roof membrane*, subject to the following terms, conditions, limitations, and exclusions, for the duration specified above from the date of completion of the *roof membrane* installation. If during the duration of this Limited Warranty, a manufacturing defect in the *roof membrane* causes a leak, CertainTeed or its designated roofing contractor will, at CertainTeed's sole discretion, repair or replace the *roof membrane* materials only as necessary to restore it to a watertight condition.

Only manufacturing defects in the *roof membrane* that cause leaks are covered by this Limited Warranty.

CertainTeed's MAXIMUM LIABILITY during the first year of this warranty is the original cost of the CertainTeed membrane materials only. After the first year, CertainTeed's maximum liability is the original cost of the CertainTeed materials used on the roof reduced by 8.3% for 12-year warranty and 10% for 10-year warranty during each subsequent year, less any costs previously incurred by CertainTeed for repair or replacements.

Roof components which **are not** part of the *roof membrane* and hence **not** covered by this Limited Warranty include, but are not limited to, the following: underlying roof deck, insulation, vapor retarders, fasteners, metal work, drains, pitch pans, expansion joints, skylights, vents, plastic accessories, any flashing, decorative or reflective coating, surfacing and/or any aggregates. In no event, however, will CertainTeed be responsible for any costs related to the removal or abatement of any asbestos present in any existing roof system to which the CertainTeed *roof membrane* is applied.

Beyond SureStart Protection

If CertainTeed determines its shingles are defective after the SureStart period, CertainTeed's maximum contribution toward the cost of repairing or replacing defective shingles will be calculated using the Maximum Material Liability After SureStart Period figure specified in Table 1, less the Reduction Figure Per Month for the number of months from the start of the warranty period to the date when CertainTeed determines the shingles are defective. Labor costs, roof tear-off, metal work, flashing and disposal expenses, and other costs or expenses incurred during such repair or replacement are not covered or reimbursed by this Limited Warranty.

Transferability

This Limited Warranty is transferable, but only by the original property owner/consumer to the first subsequent property owner. After the Limited Warranty has been transferred once, it is no longer transferable. The warranty transfer is only effective if the subsequent property owner provides written notice of the transfer to CertainTeed within sixty (60) days from the real estate title transfer date. (Notice must be sent to CertainTeed Roofing Technical Services Department, 1400 Union Meeting Road, Blue Bell, PA 19422).

Transfers During the SureStart Period

If this Limited Warranty is transferred during the product's SureStart period, the warranty for the new owner is the same as it would have been for the original owner, except for products with Lifetime warranty periods where the duration of the transferred warranty will be 50 years measured from the beginning of the SureStart period (i.e. the date of installation), and the remaining period of SureStart protection will be available to the subsequent property owner.

Transfers After the SureStart Period

If this Limited Warranty is transferred by the original property owner/consumer after the SureStart period, the warranty following the transfer will be limited to two (2) years from the date of real estate title transfer. The warranty obligation will be calculated as explained in the section on page 4 titled "Beyond SureStart Protection."

Limitations

This Limited Warranty does not provide protection against, and CertainTeed will have no liability for, any failure, defect or damage caused by situations and events beyond normal exposure conditions, including but not limited to:

- Winds, including gusts, greater than the Wind Warranty MPH in Table 1, lightning, hurricanes, tornado, hailstorm, earthquake, fire, explosion, flood or falling objects.
- Distortion, cracking or other failure or movement of: the base material over which the shingles are applied, the roof deck, or the walls or foundation of the building itself.
- Damage caused by structural changes, alterations or additions, or by the installation of equipment (such as, but not limited to, aerials, signs or air-conditioning equipment) to the building after the original shingles have been applied.
- Shading, stains or discoloration to the shingles arising from outside sources such as, but not limited to, algae (unless blue-green algae as described in the section titled "Limited Algae Warranty"), fungus, moss, lichens or other vegetation, mold or mildew growth, or paints, chemicals or other similar materials.
- Misuse, abuse, neglect, or improper transportation, handling or storage of the shingles.
- Installation of the shingles over non-approved roof decks as more fully explained in CertainTeed's installation instructions published at the time of original installation.
- Damage caused by improper installation or installation not in accordance with CertainTeed's installation instructions published at the time of original installation.
- Damage to the shingles, the roof deck or the structure caused by ice backup or ice damming.
- Vandalism or acts of war.
- Any other cause not a result of a manufacturing defect in the shingles.

Mold and mildew are functions of environmental conditions and are not manufacturing defects. As such, mold and mildew are not covered by this Limited Warranty or any implied warranty.

CertainTeed reserves the right to discontinue or modify any of its products, including the color of its shingles, and shall not be liable as a result of such discontinuance or modification, nor shall CertainTeed be liable in the event replacement material varies in color in comparison to the original product as a result of normal weathering. If CertainTeed replaces any material under this warranty, it may substitute products designated by CertainTeed to be of comparable quality or price range in the event the product initially installed has been discontinued or modified.

Inadequately Ventilated and Non-Ventilated Decks

Any shingles applied to inadequately ventilated or non-ventilated decks, other than the shingles and deck systems described in the section titled “Insulated Decks and Radiant Barriers,” are subject to a reduced limited warranty period of ten (10) years and do not qualify for SureStart Protection. SureStart Protection and the Warranty Period applicable to the shingle are available if CertainTeed determines that the shingle damage was caused exclusively by a manufacturing defect that is unrelated to the inadequate roof system ventilation.

Insulated Decks and Radiant Barriers

CertainTeed’s Limited Warranty, including SureStart Protection, will remain in force when its fiber glass shingles are applied to roof deck assemblies where foam insulation is prefabricated into the roof deck system (often called “nailboard insulation”), where insulation is installed beneath an acceptable roof deck system, or where radiant barriers are installed, with or without ventilation, directly below the deck. Acceptable roof deck surfaces must consist of at least 3/8” thick plywood or 7/16” thick Oriented Strand Board (OSB) and slopes must be 2:12 or greater. If a different deck surface material will be utilized, please contact CertainTeed’s Technical Services Department for assistance. (See the following [important restrictions](#).)

The design professional is responsible for ensuring: 1) the proper quality and application of the insulation and/or radiant barrier, 2) the provision of adequate structural ventilation and/or vapor retarders as determined to be necessary, and 3) that all local codes are met (particularly taking into account local climate conditions). Special attention must be taken if cellular foam, fiber glass, cellulose insulation or other highly permeable insulation will be used in an unventilated system, or if the insulation/rafter or insulation/joist planes may create an air leak that could lead to moisture transmission and condensation problems. All these important factors and decisions, while not the responsibility of CertainTeed, are critical to assure proper deck system performance.

Ventilated Nail-Base Roof Insulation

Ventilated Nail-Base Roof Insulation products (e.g. Flint Board™ CV) are made of rigid insulation (typically foam board) and another layer of material that provides air space above the insulation and below the nailable deck (which is typically at least 7/16” thick OSB or 3/8” thick plywood). These products can provide soffit-to-ridge ventilation, and if installed in accordance with the deck manufacturer’s instructions to achieve sufficient ventilation, will not reduce the scope or length of CertainTeed’s Limited Warranty coverage.

Limited Algae Warranty

Blue-green algae, which is commonly but incorrectly called “fungus,” can create unsightly streaking on shingles. CertainTeed warrants that the Algae-Resistant (AR) versions of Grand Manor™, Centennial Slate™, Carriage House™, Presidential Shake™ TL, Landmark™ TL, and Presidential Shake™ shingles will remain free from blue-green algae growth (but not mold or mildew growth) which adversely affects the overall appearance of said shingles for a period of fifteen (15) years, and that Independence™, Hatteras®, Landmark™ Premium, Landmark™ Woodscape Premium, Landmark™ Plus, Landmark™ Special, Landmark™, Landmark™ Woodscape, Classic Horizon, XT™ 30, XT™ 25 and CT 20 shingles will remain free from blue-green algae growth (but not mold or mildew growth) which adversely affects the overall appearance of said shingles for a period of ten (10) years. If during the Algae-Resistant Warranty Period specified in Table 1, the overall appearance of the Algae-Resistant shingles is adversely affected by blue-green algae, CertainTeed will pay the reasonable cost to replace or clean at its option, any affected shingles. In the event of replacement or cleaning, for the remainder of the Algae-Resistant Warranty Period, CertainTeed’s maximum contribution towards subsequent replacement or cleaning will be calculated using the Algae-Resistant Warranty Period specified in Table 1, less a prorated adjustment that reflects the number of months that have elapsed from the start of the Algae-Resistant Warranty Period to the date of reoccurrence.

WARNING: FOR LOW-VOLUME RAIN AND SALT FOG AREAS

In areas of low-volume rain (e.g. areas that receive insignificant rainfall during a 90-day period) and/or “salt fog” (e.g. parts of the Southern California coastline), copper released by algae-resistant (AR) granules or shingles can react with aluminum in gutters and cause severe corrosion of the gutters. In such regions, CertainTeed strongly recommends that vinyl or copper gutters, not aluminum gutters, be used with algae-resistant

shingles. **CertainTeed disclaims all liability and responsibility for any damages that may result from the use of its algae-resistant shingle products with copper granules where gutters containing aluminum are used.**

Limited Wind Warranty

CertainTeed warrants its shingles will resist blow-off damage due to wind velocities, including gusts, up to the maximum wind velocity per the Wind Warranty MPH specified in Table 1 during the first ten (10) years of the warranty for Grand Manor™, Centennial Slate™, Carriage House™, Presidential Shake™ TL, Landmark™ TL, Presidential Shake™, Hatteras®, Landmark™ Premium, Landmark™ Woodscape Premium, and Landmark™ Solaris, and during the first five (5) years of the warranty for all other CertainTeed shingle products listed in Table 1.

CertainTeed's obligations and liability for shingle blow-off damage during the wind warranty periods as specified above are limited as follows:

- If shingles blow off because the shingle's self-sealing asphalt strips did not activate, CertainTeed will have no liability or warranty obligation unless CertainTeed is afforded the opportunity to hand seal, at its expense, any non-sealing shingles.
- If shingles blow off even though the shingle's self-sealing asphalt strips did activate, CertainTeed will furnish replacement shingles without charge, but only for damaged or blown off shingles. CertainTeed will not be responsible for or reimburse labor costs, roof tear-off, metal work, flashing and disposal expenses, or any other costs pertaining to removal or replacement of damaged shingles. Any costs in excess of CertainTeed's material contribution are the property owner's responsibility (and may be covered by homeowner's insurance).
- CertainTeed shall have no liability for any shingles not fastened in accordance with CertainTeed installation instructions published at the time of original installation.
- CertainTeed shall have no liability for any damage to persons or property caused by blown off shingles.
- CertainTeed's maximum liability during the wind warranty period is the reasonable cost of hand sealing all of the shingles on the roof.

What the Customer Must Do

If you believe your shingles have a manufacturing defect, you must promptly notify CertainTeed and provide proof of property ownership and the date of shingle purchase and application. Unless you provide such proof, CertainTeed will use the date of manufacture to calculate the start of the warranty period. In order to properly evaluate and process a warranty claim, CertainTeed may require the property owner to submit a shingle sample to CertainTeed for analysis and/or permit a CertainTeed representative to make repairs to, take photographs of, and/or take samples from the roof, if required. CertainTeed will evaluate each properly reported claim and will repair, replace, clean or reimburse the property owner for the shingles it determines are defective, in accordance with the terms of this Limited Warranty within a reasonable amount of time. For more details about submitting a warranty claim, visit www.ctroof.com or call (800) 345-1145.

Please send all notifications and correspondence to:

CertainTeed Corporation, 1400 Union Meeting Road, Blue Bell, PA 19422,

Attn: CertainTeed Roofing Technical Services Department. Telephone number: 800-345-1145.

Warranty Registration (not required)

You may register your product warranty on CertainTeed's website: www.certainteed.com/warrantyreg. Each registrant receives a registration confirmation number by return e-mail that can be printed and kept with this Limited Warranty and your proof of purchase. If you do not have internet access, you can register your shingles by sending: (1) your name, address, and telephone number; (2) the name and contact information of the contractor who installed your shingles and the original date of installation; and, (3) the type, color and number of squares of your shingles to:

CertainTeed Corporation, 1400 Union Meeting Road, Blue Bell, PA 19422,

Attn: CertainTeed Roofing Technical Services Department.

CertainTeed will register your information and mail you a confirmation number.

Failure to register this warranty does NOT void the warranty or any of its terms.

FOR YOUR RECORDS

Product Purchased: _____ Date of Installation: _____

Roofing Contractor: _____ Contractor's Telephone No. _____

This warranty applies to shingles installed during the calendar year of 2010.

(The warranty in effect at the time the material is originally installed is the applicable warranty.)

Limited Warranty and Limitation of Remedies

THIS DOCUMENT CONSTITUTES THE EXCLUSIVE WARRANTIES AND REMEDIES PROVIDED BY CERTAINTEED. THE WARRANTIES AND REMEDIES CONTAINED IN THIS DOCUMENT ARE EXPRESSLY IN LIEU OF ANY AND ALL OTHER OBLIGATIONS, GUARANTEES AND WARRANTIES, WHETHER WRITTEN, ORAL OR IMPLIED BY STATUTE OR AT LAW. STATE OR PROVINCIAL LAW WILL DETERMINE THE PERIOD OF TIME FOLLOWING THE SALE THAT A PROPERTY OWNER MAY SEEK A REMEDY UNDER THE IMPLIED WARRANTY OF MERCHANTABILITY OR FITNESS FOR A PARTICULAR PURPOSE.

CERTAINTEED'S OBLIGATIONS, RESPONSIBILITIES, AND LIABILITY SHALL BE LIMITED TO REPAIRING OR REPLACING THE DEFECTIVE PRODUCT OR CLEANING ALGAE-RESISTANT SHINGLES IN THE CASE OF ALGAE GROWTH AS SET FORTH IN THIS LIMITED WARRANTY. IN NO EVENT SHALL CERTAINTEED BE LIABLE FOR ANY SPECIAL, INDIRECT, INCIDENTAL OR CONSEQUENTIAL DAMAGES OF ANY KIND, INCLUDING ANY DAMAGE TO THE PROPERTY, THE BUILDING OR ITS CONTENTS, OR FOR INJURY TO ANY PERSONS, THAT MAY OCCUR AS A RESULT OF THE USE OF CERTAINTEED'S PRODUCTS OR AS A RESULT OF THE BREACH OF THIS WARRANTY. IF YOUR STATE OR PROVINCE DOES NOT ALLOW EXCLUSIONS OR LIMITATIONS OF SPECIAL, INDIRECT, INCIDENTAL OR CONSEQUENTIAL DAMAGES, THE ABOVE LIMITATIONS MAY NOT APPLY TO YOU.

IN NO EVENT SHALL CERTAINTEED'S TOTAL LIABILITY ARISING OUT OF OR RELATED TO THE PRODUCT(S) OR THIS LIMITED WARRANTY EXCEED THE REASONABLE COST OF SHINGLES AND LABOR TO REPLACE OR REPAIR THE DEFECTIVE SHINGLES.

This Limited Warranty may not be modified, altered or expanded by anyone, including product distributors, dealers, sellers and/or CertainTeed field representatives.

This Limited Warranty gives you specific legal rights, and you may also have other rights which vary from State to State, or Province to Province.

ROOFING PLANTS AND REGIONAL SALES OFFICES

CertainTeed roofing products are sold by CertainTeed Roofing in nine sales regions. They are manufactured in ten residential roofing plants and one commercial roofing plant.

Since the early 1900s, CertainTeed Corporation has been an innovator in the building materials industry and today is a leading manufacturer of building materials including residential and commercial roofing, vinyl and fiber cement siding, vinyl windows, composite decking and railing, fiber glass insulation, vinyl fence, and piping products. The company is headquartered in Valley Forge, Pennsylvania, and employs more than 7,000 employees at approximately 50 manufacturing facilities throughout North America. Continuing the 100-year commitment of "Quality made certain, Satisfaction guaranteed™," CertainTeed remains one of the most trusted names in the industry. More information is available at www.certainteed.com.

This document is also available in Spanish and French. Call 1-800-782-8777 or go to www.certainteed.com.

Se puede obtener este documento en español. Favor de llamar 1-800-782-8777.

Ce document est disponible en anglais et en espagnol. Composez le 1-800-782-8777.



Printed on FSC-certified paper.

ASK ABOUT OUR OTHER CERTAINTEED PRODUCTS AND SYSTEMS:

EXTERIOR: ROOFING • SIDING • WINDOWS • FENCE • RAILING • TRIM • DECKING • FOUNDATIONS • PIPE
INTERIOR: INSULATION • GYPSUM • CEILINGS

CertainTeed Corporation
P.O. Box 860
Valley Forge, PA 19482

Professional: 800-233-8990
Consumer: 800-782-8777
www.certainteed.com

CertainTeed

CertainTeed

Limited Warranty

Asphalt Shingle Products

2011

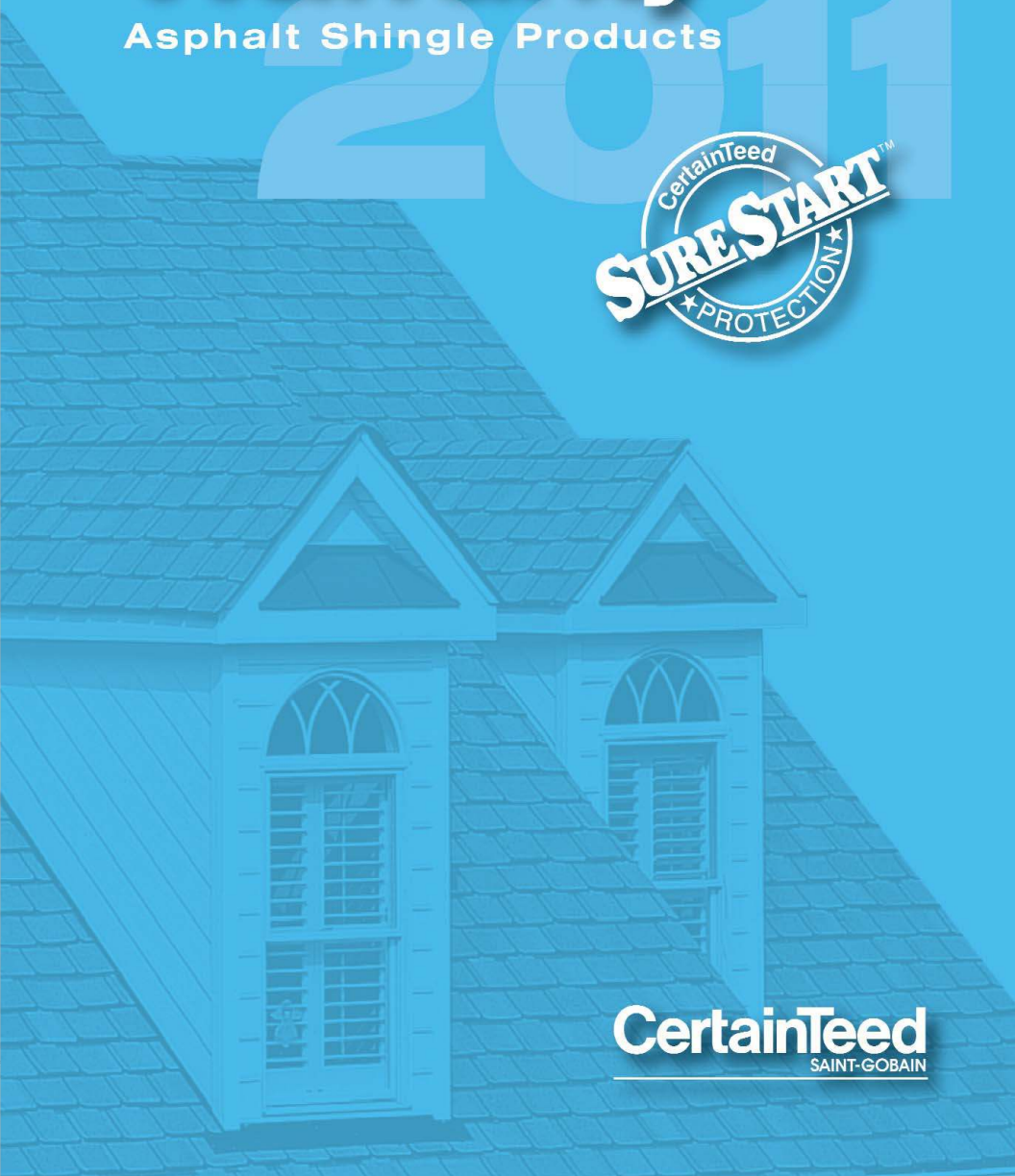

CertainTeed
SAINT-GOBAIN

Congratulations... and thank you for your recent purchase of one of the fine products from CertainTeed Roofing. Since 1904, CertainTeed has been producing quality roofing products that provide long-lasting beauty and protection for homes of every size, style and age. For over 100 years, the basis for our name, "Quality made certain, satisfaction guaranteed," has been our ongoing philosophy.

Your CertainTeed roofing warranty fully explains how CertainTeed supports its products with the strongest warranty protection available. It is important that you read the warranty section of this brochure. The warranty lists the specific CertainTeed asphalt shingle products that are covered and the period of time for which they are covered. Take the time to understand how CertainTeed protects your purchase by standing behind our products.

Limited, Prorated and Transferable Warranty

This warranty covers asphalt shingle products listed in Table 1, sold only in the United States of America, its territories and Canada.

What and Who Is Covered and for How Long

CertainTeed warrants to the original property owner/consumer that, when subject to normal and proper use, its shingles will be free from manufacturing defects for the length of time specified in Table 1 and that CertainTeed will pay to repair, replace or clean, at its option, any shingles CertainTeed determines are defective under the terms of this Limited Warranty. In the event of repair, replacement or cleaning pursuant to the terms of this Limited Warranty, the warranty applicable to the original shingles shall apply to the repaired, replaced or cleaned shingles and will extend for the balance of the original warranty period.

The Lifetime warranty period offered for certain shingles in Table 1 is only available to individual homeowners. The warranty period for shingles installed on premises not used by individual homeowners as their residence is limited as specified in Table 1. All other structures and property owners (e.g. corporations, governmental agencies, partnerships, trusts, religious organizations, schools, condominiums, homeowner associations or cooperative housing arrangements, apartment buildings, and any other type of building or premises not owned by individual homeowners) are limited to either a 50-year or 40-year warranty period described in Table 1.

Lifetime means as long as the original individual home owner (or the second owner, if the warranty was properly transferred during the SureStart period) owns the property where the shingles are installed.

SureStart™ Protection

Because CertainTeed roofing products are manufactured to the highest quality standards, we confidently include the additional assurance of SureStart™ protection. SureStart provides the strongest non prorated protection you can get in the vital early years of your new roof.

All of CertainTeed's shingle products are covered by SureStart protection. Under this warranty feature, CertainTeed, at no charge, will pay to repair or replace, at its option, any shingles CertainTeed determines are defective during the SureStart period. Note: Wind warranty and algae warranty are covered separately as described on pages 4 & 5. The SureStart period begins on the date of application and terminates following the period specified in Table 1. CertainTeed's maximum liability under SureStart is equal to the reasonable cost of comparable replacement shingles and labor as determined by CertainTeed to replace or repair the defective shingles. Roof tear-off, metal work, flashing and disposal expenses, and other costs or expenses incurred during such repair or replacement are not covered or reimbursed by this Limited Warranty, except for certain products with Lifetime warranty periods specified in Table 1, for which CertainTeed's maximum liability also includes the cost of roof tear-off and disposal.

In instances in which CertainTeed, under the terms of this warranty, has agreed to pay the reasonable cost of labor required to repair or replace defective shingles, CertainTeed will provide reimbursement only upon receipt of a copy of the contractor's invoice or other written evidence of the completion of such work which CertainTeed, in its sole discretion, deems acceptable.

SureStart protection does not extend to any shingles applied to non-ventilated or inadequately ventilated roof deck systems as determined by CertainTeed, except as stated on page 4. CertainTeed's maximum contribution toward the cost of repairing or replacing defective shingles applied to a non-ventilated or inadequately ventilated roof deck system is calculated using the

reasonable cost of comparable replacement shingles as determined by CertainTeed less 1/120th of that amount multiplied by the number of months from the start of the warranty period to the date when CertainTeed determines the shingles are defective. Labor costs, roof tear-off, metal work, flashing and disposal expenses, and other costs or expenses incurred during such repair or replacement are not covered or reimbursed by this Limited Warranty.

Beyond SureStart Protection

If CertainTeed determines its shingles are defective after the SureStart period, CertainTeed's maximum contribution toward the cost of repairing or replacing defective shingles will be calculated using the reasonable cost of comparable replacement shingles as determined by CertainTeed less the Reduction Figure Per Month, specified in Table 1, for the number of months from the start of the warranty period to the date when CertainTeed determines the shingles are defective. Labor costs, roof tear-off, metal work, flashing and disposal expenses, and other costs or expenses incurred during such repair or replacement are not covered or reimbursed by this Limited Warranty.

TABLE 1

<u>Lifetime Products^A</u>	<u>Warranty Period</u>	<u>SureStart Period</u>	<u>Wind Warranty Miles Per Hour</u>	<u>Algae Resistant Warranty Period¹</u>	<u>Reduction Figure Per Month</u>
Grand Manor™ Presidential Shake™ TL Landmark™ TL (& IR) ² Centennial Slate™ Presidential Shake™ (& IR) ² Carriage House™ Landmark™ Premium Landmark Solaris™ (& IR) ² Highland Slate™ (& IR) ² Independence™	Lifetime ^A	10 Years	110 ^{††}	15	1/600*
<u>Lifetime Products^B</u>	<u>Warranty Period</u>	<u>SureStart Period</u>	<u>Wind Warranty Miles Per Hour</u>	<u>Algae Resistant Warranty Period¹</u>	<u>Reduction Figure Per Month</u>
Landmark™ Special ² Landmark™ Plus Landmark™ Canada Landmark™ Hatteras [®]	Lifetime ^B	10 Years	110 ^{††}	10	1/600*
<u>20 - , 25 - and 30 - Year Products</u>	<u>Warranty Period</u>	<u>SureStart Period</u>	<u>Wind Warranty Miles Per Hour</u>	<u>Algae Resistant Warranty Period¹</u>	<u>Reduction Figure Per Month</u>
XT 30™ (& IR) ²	30 Years	5 Years	70 ^{†††}	10	1/360
XT 25™	25 Years	5 Years	60	10	1/300
CT 20™	20 Years	3 Years	60	10	1/240
Any shingles applied to any inadequately ventilated roof deck	10 years [†]	N/A	N/A	N/A	1/120

A. The Lifetime Warranty period is only available to individual homeowners. The warranty period for these shingles installed on premises not used by individual homeowners as their residence is limited to 50 years and the SureStart period is 10 years following the installation of the shingles. Roof tear-off and disposal expense, incurred during repair or replacement are covered or reimbursed by this Limited Warranty. Limited Warranty transferees during the SureStart period are limited to a 50-year warranty period (see section titled "Transfers During the SureStart Period" for details).

B. The Lifetime Warranty period is only available to individual homeowners. The warranty period for these shingles installed on premises not used by individual homeowners as their residence is limited to 40 years and the SureStart period is 5 years following the installation of the shingles. Limited Warranty transferees during the SureStart period are limited to a 40-year warranty period (see section titled "Transfers During the SureStart Period" for details).

* For Lifetime products, at the completion of the 40th year the reduction figure will remain at 480/600, or 20% of the total maximum liability.

† For details of warranty coverage for shingles installed on inadequately ventilated roof decks on both residential and commercial buildings, see provisions under "Inadequately Ventilated and Non-Ventilated Decks."

†† Wind warranty upgrade – These products are warranted to resist blow-off due to wind velocities, including gusts, up to a maximum of 130 miles per hour during the first fifteen (15) years, provided all of the following conditions are met:

1. The CertainTeed shingles are not applied over existing roof shingles (roof-overs are not permitted).
2. The CertainTeed specified corresponding hip and ridge accessory products are installed as cap shingles (Shadow Ridge™, Cedar Crest™ (& IR), Shangle Ridge™, Mountain Ridge™ Landmark Solaris™ (& IR) and Hatteras™).
3. The CertainTeed specified corresponding starter shingles are installed along the roof eaves and rakes (Swiftstart™, High-Performance Starter and Presidential Starter).

(Note: In Florida, CertainTeed will waive the requirement of applying starter shingles along the roof rake if all of the following conditions are met: The applicable building code requires that asphalt roof shingles be embedded in an 8-inch-wide bed of asphalt roofing cement applied along the roof rake edges. And, the shingles are installed and embedded in an 8-inch-wide bed of asphalt roofing cement along the roof rake edges in accordance with the code.)

††† The Wind warranty for XT 30 (& IR) for the Northwest region is 80 mph. The Wind warranty is 100 mph in Hawaii and Alaska only.

¹Algae Resistant Warranty period applies only to the Algae Resistant (AR) version of the pertinent shingle.

²CertainTeed's Impact Resistant (IR) versions of Landmark™ TL, Landmark™, Presidential Shake™, Highland Slate™, Landmark Solaris™, and XT™ 30 shingles comply with UL 2218 Impact Resistance of Prepared Roof Covering Materials test criteria at time of manufacture.

Transferability

This Limited Warranty is transferable, but only by the original property owner/consumer to the first subsequent property owner. After the Limited Warranty has been transferred once, it is no longer transferable. The warranty transfer is only effective if the subsequent property owner provides written notice of the transfer to CertainTeed within sixty (60) days from the real estate title transfer date. (Notice must be sent to CertainTeed Roofing Technical Services Department, 1400 Union Meeting Road, Blue Bell, PA 19422.)

Transfers During the SureStart Period

If this Limited Warranty is properly transferred during the product's SureStart period, the warranty for the new owner is the same as it would have been for the original owner, except for certain products with Lifetime warranty periods where the duration of the transferred warranty will be 50 years or 40 years as specified in Table 1, measured from the beginning of the SureStart period (i.e. the date of installation), and the remaining period of SureStart protection will be available to the subsequent property owner.

Transfers After the SureStart Period

If this Limited Warranty is properly transferred by the original property owner/consumer after the SureStart period, the warranty following the transfer will be limited to two (2) years from the date of real estate title transfer. The warranty obligation will be calculated as explained in the section titled "Beyond SureStart Protection."

Limitations

This Limited Warranty does not provide protection against, and CertainTeed will have no liability for, any failure, defect or damage caused by situations and events beyond normal exposure conditions, including but not limited to:

- Winds, including gusts, greater than the Wind Warranty MPH in Table 1.
- Damage caused by lightning, hailstorm, earthquake, fire, explosion, flood or falling objects.
- Damage caused by tornado, or hurricanes (other than as warranted under Wind Warranty MPH in Table 1).
- Distortion, cracking or other failure or movement of: the base material over which the shingles are applied, the roof deck, or the walls or foundation of the building itself.
- Damage caused by structural changes, alterations or additions, or by the installation of equipment (such as, but not limited to, aerials, signs or air-conditioning equipment) to the building after the original shingles have been applied.
- Shading, stains or discoloration to the shingles arising from outside sources such as, but not limited to, algae (unless blue-green algae as described in the section titled "Limited Algae Warranty"), fungus, moss, lichens or other vegetation, mold or mildew growth, or paints, chemicals or other similar materials.

- Misuse, abuse, neglect, or improper transportation, handling or storage of the shingles.
- Installation of the shingles over non-approved roof decks as more fully explained in CertainTeed's installation instructions published at the time of original installation.
- Damage caused by improper installation or installation not in accordance with CertainTeed's installation instructions published at the time of original installation.
- Damage to the shingles, the roof deck or the structure caused by ice backup or ice damming.
- Vandalism or acts of war.
- Any other cause not a result of a manufacturing defect in the shingles.

Mold and mildew are functions of environmental conditions and are not manufacturing defects. As such, mold and mildew are not covered by this Limited Warranty or any implied warranty. CertainTeed reserves the right to discontinue or modify any of its products, including the color of its shingles, and shall not be liable as a result of such discontinuance or modification, nor shall CertainTeed be liable in the event replacement material varies in color in comparison to the original product as a result of normal weathering. If CertainTeed replaces any material under this warranty, it may substitute products designated by CertainTeed to be of comparable quality or price range in the event the product initially installed has been discontinued or modified.

Inadequately Ventilated and Non-Ventilated Decks

Any shingles applied to inadequately ventilated or non-ventilated decks, other than the shingles and deck systems described in the section titled "Insulated Decks and Radiant Barriers," are subject to a reduced limited warranty period of ten (10) years and do not qualify for SureStart Protection. SureStart Protection and the Warranty Period applicable to the shingle are available if CertainTeed determines that the shingle damage was caused exclusively by a manufacturing defect that is unrelated to the inadequate roof system ventilation.

Insulated Decks and Radiant Barriers

CertainTeed's Limited Warranty, including SureStart Protection, will remain in force when its fiber glass shingles are applied to roof deck assemblies where foam insulation is prefabricated into the roof deck system (often called "nailboard insulation"), where insulation is installed beneath an acceptable roof deck system, or where radiant barriers are installed, with or without ventilation, directly below the deck. Acceptable roof deck surfaces must consist of at least 3/8" thick plywood or 7/16" thick Oriented Strand Board (OSB) and slopes must be 2:12 or greater. If a different deck surface material will be utilized, please contact CertainTeed's Technical Services Department for assistance. (See the following important restrictions.)

The design professional is responsible for ensuring: 1) the proper quality and application of the insulation and/or radiant barrier, 2) the provision of adequate structural ventilation and/or vapor retarders as determined to be necessary, and 3) that all local codes are met (particularly taking into account local climate conditions). Special attention must be taken if cellular foam, fiber glass, cellulose insulation or other highly permeable insulation will be used in an unventilated system, or if the insulation/rafter or insulation/joist planes may create an air leak that could lead to moisture transmission and condensation problems. All these important factors and decisions, while not the responsibility of CertainTeed, are critical to assure proper deck system performance.

Ventilated Nail-Base Roof Insulation

Ventilated Nail-Base Roof Insulation products (e.g. Flint Board™ CV) are made of rigid insulation (typically foam board) and another layer of material that provides air space above the insulation and below the nailable deck (which is typically at least 7/16" thick OSB or 3/8" thick plywood). These products can provide soffit-to-ridge ventilation, and if installed in accordance with the deck manufacturer's instructions to achieve sufficient ventilation, will not reduce the scope or length of CertainTeed's Limited Warranty coverage.

Limited Algae Warranty

Blue-green algae, which is commonly but incorrectly called "fungus," can create unsightly streaking on shingles. CertainTeed warrants that the Algae-Resistant (AR) versions of the products in Table 1 will remain free from blue-green algae growth (but not mold or mildew growth) which adversely affects the overall appearance of said shingles for a period of ten (10) or fifteen (15) years, as noted in Table 1.

If during the Algae-Resistant Warranty Period specified in Table 1, the overall appearance of the Algae-Resistant shingles is adversely affected by blue-green algae, CertainTeed will pay the reasonable cost to replace or clean at its option, any affected shingles. In the event of replacement or cleaning, for the remainder of the Algae-Resistant Warranty Period, CertainTeed's maximum contribution towards subsequent replacement or cleaning will be calculated using the Algae-Resistant Warranty Period specified in Table 1, less a prorated adjustment that reflects the number of months that have elapsed from the start of the Algae-Resistant Warranty Period to the date of reoccurrence.

WARNING: FOR LOW-VOLUME RAIN AND SALT FOG AREAS

In areas of low-volume rain (e.g. areas that receive insignificant rainfall during a 90-day period) and/or "salt fog" (e.g. parts of the Southern California coastline), copper released by algae-resistant (AR) granules or shingles can react with aluminum in gutters and cause severe corrosion of the gutters. In such regions, CertainTeed strongly recommends that vinyl or copper gutters, not aluminum gutters, be used with algae-resistant shingles. CertainTeed disclaims all liability and responsibility for any damages that may result from the use of its algae-resistant shingle products with copper granules where gutters containing aluminum are used.

Limited Wind Warranty

CertainTeed warrants its shingles will resist blow-off damage due to wind velocities, including gusts, up to the maximum wind velocity per the Wind Warranty MPH specified in Table 1 during the first fifteen (15) years of the warranty for Lifetime products and during the first five (5) years for all other products listed in Table 1.

CertainTeed's obligations and liability for shingle blow-off damage during the wind warranty periods as specified above are limited as follows:

- If shingles blow off because the shingle's self-sealing asphalt strips did not activate, CertainTeed will have no liability or warranty obligation unless CertainTeed is afforded the opportunity to hand seal, at its expense, any non-sealing shingles.
- If shingles blow off even though the shingle's self-sealing asphalt strips did activate, CertainTeed will furnish replacement shingles without charge, but only for damaged or blown off shingles. CertainTeed will not be responsible for or reimburse labor costs, roof tear-off, metal work, flashing and disposal expenses, or any other costs pertaining to removal or replacement of damaged shingles. Any costs in excess of CertainTeed's material contribution are the property owner's responsibility (and may be covered by homeowner's insurance).
- CertainTeed shall have no liability for any shingles not fastened in accordance with CertainTeed installation instructions published at the time of original installation.
- CertainTeed shall have no liability for any damage to persons or property caused by blown off shingles.
- CertainTeed's maximum liability during the wind warranty period is the reasonable cost of hand sealing all of the shingles on the roof.

Flintlastic™ SA (Self-Adhering) System

For low slope residential roofing projects less than 2000 square feet (20 squares), CertainTeed offers a limited roof membrane warranty as follows: A 10-year warranty duration on a single ply of Flintlastic SA Cap sheet over a primed plywood roof deck or a 12-year warranty duration for a two-ply system consisting of a Flintlastic SA Nail Base and a Flintlastic SA Cap sheet, provided the Flintlastic products were applied in accordance with CertainTeed's current installation instructions published at the time of installation.

CertainTeed warrants the roof membrane, subject to the following terms, conditions, limitations, and exclusions, for the duration specified above from the date of completion of the roof membrane installation. If during the duration of this Limited Warranty, a manufacturing defect in the roof membrane causes a leak, CertainTeed or its designated roofing contractor will, at CertainTeed's sole discretion, repair or replace the roof membrane materials only as necessary to restore it to a watertight condition.

Only manufacturing defects in the roof membrane that cause leaks are covered by this Limited Warranty. CertainTeed's MAXIMUM LIABILITY during the first year of this warranty is the original cost of the CertainTeed membrane materials only. After the first year, CertainTeed's maximum liability is the original cost of the CertainTeed materials used on the roof reduced by 8.3% for 12-year warranty and 10% for 10-year warranty during each subsequent year, less any costs previously incurred by CertainTeed for repair or replacements.

Roof components which are not part of the roof membrane and hence not covered by this Limited Warranty include, but are not limited to, the following: underlying roof deck, insulation, vapor retarders, fasteners, metal work, drains, pitch pans, expansion joints, skylights, vents, plastic accessories, any flashing, decorative or reflective coating, surfacing and/or any aggregates. In no event, however, will CertainTeed be responsible for any costs related to the removal or abatement of any asbestos present in any existing roof system to which the CertainTeed roof membrane is applied.

What the Customer Must Do

If you believe your shingles have a manufacturing defect, you must promptly notify CertainTeed and provide proof of property ownership and the date of shingle purchase and application. Unless you provide such proof, CertainTeed will use the date of manufacture to calculate the start of the warranty period. In order to properly evaluate and process a warranty claim, CertainTeed may require the property owner to submit a shingle sample to CertainTeed for analysis and/or permit a CertainTeed representative to make repairs to, take photographs of, and/or take samples from the roof, if required. CertainTeed will evaluate each properly reported claim and will repair, replace, clean or reimburse the property owner for the shingles it determines are defective, in accordance with the terms of this Limited Warranty within a reasonable amount of time. For more details about submitting a warranty claim, visit www.ctroof.com or call (800) 345-1145.

Please send all notifications and correspondence to:

CertainTeed Corporation, 1400 Union Meeting Rd., P.O. Box 1100, Blue Bell, PA 19422, Attn: CertainTeed Roofing Technical Services Department. Telephone number: 800-345-1145.

Warranty Registration (not required)

You may register your product warranty on CertainTeed's website:

www.certainteed.com/warrantyreg. Each registrant receives a registration confirmation number by return e-mail that can be printed and kept with this Limited Warranty and your proof of purchase. If you do not have internet access, you can register your shingles by sending: (1) your name, address, and telephone number; (2) the name and contact information of the contractor who installed your shingles and the original date of installation; and, (3) the type, color and number of squares of your shingles to: **CertainTeed Corporation, 1400 Union Meeting Rd., P.O. Box 1100, Blue Bell, PA 19422, Attn: CertainTeed Roofing Technical Services Department.**

CertainTeed will register your information and mail you a confirmation number. Failure to register this warranty does NOT void the warranty or any of its terms.

For Your Records

Product Purchased: _____ Date of Installation: _____

Roofing Contractor: _____ Contractor's Telephone No. _____

This warranty applies to shingles installed during the calendar year of 2011.

(The warranty in effect at the time the material is originally installed is the applicable warranty.)

Limited Warranty and Limitation of Remedies

THIS DOCUMENT CONSTITUTES THE EXCLUSIVE WARRANTIES AND REMEDIES PROVIDED BY CERTAINTEED. THE WARRANTIES AND REMEDIES CONTAINED IN THIS DOCUMENT ARE EXPRESSLY IN LIEU OF ANY AND ALL OTHER OBLIGATIONS, GUARANTEES AND WARRANTIES, WHETHER WRITTEN, ORAL OR IMPLIED BY STATUTE OR AT LAW. STATE OR PROVINCIAL LAW WILL DETERMINE THE PERIOD OF TIME FOLLOWING THE SALE THAT A PROPERTY OWNER MAY SEEK A REMEDY UNDER THE IMPLIED WARRANTY OF MERCHANTABILITY OR FITNESS FOR A PARTICULAR PURPOSE.

CERTAINTEED'S OBLIGATIONS, RESPONSIBILITIES, AND LIABILITY SHALL BE LIMITED TO REPAIRING OR REPLACING THE DEFECTIVE PRODUCT OR CLEANING ALGAE-RESISTANT SHINGLES IN THE CASE OF ALGAE GROWTH AS SET FORTH IN THIS LIMITED WARRANTY. IN NO EVENT SHALL CERTAINTEED BE LIABLE FOR ANY SPECIAL, INDIRECT, INCIDENTAL OR CONSEQUENTIAL DAMAGES OF ANY KIND, INCLUDING ANY DAMAGE TO THE PROPERTY, THE BUILDING OR ITS CONTENTS, OR FOR INJURY TO ANY PERSONS, THAT MAY OCCUR AS A RESULT OF THE USE OF CERTAINTEED'S PRODUCTS OR AS A RESULT OF THE BREACH OF THIS WARRANTY. IF YOUR STATE OR PROVINCE DOES NOT ALLOW EXCLUSIONS OR LIMITATIONS OF SPECIAL, INDIRECT, INCIDENTAL OR CONSEQUENTIAL DAMAGES, THE ABOVE LIMITATIONS MAY NOT APPLY TO YOU.

IN NO EVENT SHALL CERTAINTEED'S TOTAL LIABILITY ARISING OUT OF OR RELATED TO THE PRODUCT(S) OR THIS LIMITED WARRANTY EXCEED THE REASONABLE COST OF SHINGLES AND LABOR TO REPLACE OR REPAIR THE DEFECTIVE SHINGLES.

This Limited Warranty may not be modified, altered or expanded by anyone, including product distributors, dealers, sellers and/or CertainTeed field representatives.

This Limited Warranty gives you specific legal rights, and you may also have other rights which vary from State to State, or Province to Province.

Roofing Plants and Regional Sales Office

CertainTeed roofing products are sold by CertainTeed Roofing in nine sales regions. They are manufactured in ten residential roofing plants and one commercial roofing plant. Since the early 1900s, CertainTeed Corporation has been an innovator in the building materials industry and today is a leading manufacturer of building materials including residential and commercial roofing, vinyl and fiber cement siding, vinyl windows, composite decking and railing, fiber glass insulation, vinyl fence, and piping products. The company is headquartered in Valley Forge, Pennsylvania, and employs more than 7,000 employees at approximately 50 manufacturing facilities throughout North America. Continuing the 100-year commitment of "Quality made certain, Satisfaction guaranteed™," CertainTeed remains one of the most trusted names in the industry. More information is available at www.certainteed.com.

This document is also available in Spanish and French.

Call 1-800-782-8777 or go to www.certainteed.com.

Se puede obtener este documento en español. Favor de llamar 1-800-782-8777.

Ce document est disponible en anglais et en espagnol. Composez le 1-800-782-8777.



Printed on FSC-certified paper

ASK ABOUT OUR OTHER CERTAINTEED® PRODUCTS AND SYSTEMS

ROOFING • SIDING • TRIM • WINDOWS • DECKING • RAILING • FENCE
INSULATION • GYPSUM • CEILINGS • FOUNDATIONS • PIPE

www.certainteed.com <http://blog.certainteed.com>

CertainTeed Corporation
P.O. Box 860 / Valley Forge, PA 19482
Professional: 800-233-8990 / Consumer: 800-782-8777

©1/11 CertainTeed Corporation, Printed in U.S.A.
20-20-3241REV



CertainTeed

Limited Warranty

Asphalt Shingle Products



CertainTeed
SAINT-GOBAIN

Congratulations... and thank you for your recent purchase of one of the fine products from CertainTeed Roofing. Since 1904, CertainTeed has been producing quality roofing products that provide long-lasting beauty and protection for homes of every size, style and age. For over 100 years, the basis for our name, "Quality made certain, satisfaction guaranteed," has been our ongoing philosophy.

Your CertainTeed roofing warranty fully explains how CertainTeed supports its products with the strongest warranty protection available. It is important that you read the warranty section of this brochure. The warranty lists the specific CertainTeed asphalt shingle products that are covered and the period of time for which they are covered. Take the time to understand how CertainTeed protects your purchase by standing behind our products.

Limited, Prorated and Transferable Warranty

This warranty covers asphalt shingle products listed in Table 1, sold only in the United States of America, its territories and Canada.

What and Who Is Covered and for How Long

CertainTeed warrants to the original property owner/consumer that, when subject to normal and proper use, its shingles will be free from manufacturing defects for the length of time specified in Table 1 and that CertainTeed will pay to repair, replace or clean, at its option, any shingles CertainTeed determines are defective under the terms of this Limited Warranty. In the event of repair, replacement or cleaning pursuant to the terms of this Limited Warranty, the warranty applicable to the original shingles shall apply to the repaired, replaced or cleaned shingles and will extend for the balance of the original warranty period.

The Lifetime warranty period offered for certain shingles in Table 1 is only available to individual homeowners. The warranty period for shingles installed on premises not used by individual homeowners as their residence is limited as specified in Table 1. All other structures and property owners (e.g. corporations, governmental agencies, partnerships, trusts, religious organizations, schools, condominiums, homeowner associations or cooperative housing arrangements, apartment buildings, and any other type of building or premises not owned by individual homeowners) are limited to either a 50-year or 40-year warranty period described in Table 1.

Lifetime means as long as the original individual home owner (or the second owner, if the warranty was properly transferred during the SureStart period) owns the property where the shingles are installed.

SureStart™ Protection

Because CertainTeed roofing products are manufactured to the highest quality standards, we confidently include the additional assurance of SureStart™ protection. SureStart provides the strongest non prorated protection you can get in the vital early years of your new roof.

All of CertainTeed's shingle products are covered by SureStart protection. Under this warranty feature, CertainTeed, at no charge, will pay to repair or replace, at its option, any shingles CertainTeed determines are defective during the SureStart period. Note: Wind warranty and algae warranty are covered separately as described on pages 4 & 5. The SureStart period begins on the date of application and terminates following the period specified in Table 1. CertainTeed's maximum liability under SureStart is equal to the reasonable cost of comparable replacement shingles and labor as determined by CertainTeed to replace or repair the defective shingles. Roof tear-off, metal work, flashing and disposal expenses, and other costs or expenses incurred during such repair or replacement are not covered or reimbursed by this Limited Warranty, except for certain products with Lifetime warranty periods specified in Table 1, for which CertainTeed's maximum liability also includes the cost of roof tear-off and disposal.

In instances in which CertainTeed, under the terms of this warranty, has agreed to pay the reasonable cost of labor required to repair or replace defective shingles, CertainTeed will provide reimbursement only upon receipt of a copy of the contractor's invoice or other written evidence of the completion of such work which CertainTeed, in its sole discretion, deems acceptable.

SureStart protection does not extend to any shingles applied to non-ventilated or inadequately ventilated roof deck systems as determined by CertainTeed, except as stated on page 4. CertainTeed's maximum contribution toward the cost of repairing or replacing defective shingles applied to a non-ventilated or inadequately ventilated roof deck system is calculated using the

reasonable cost of comparable replacement shingles as determined by CertainTeed less 1/120th of that amount multiplied by the number of months from the start of the warranty period to the date when CertainTeed determines the shingles are defective. Labor costs, roof tear-off, metal work, flashing and disposal expenses, and other costs or expenses incurred during such repair or replacement are not covered or reimbursed by this Limited Warranty.

Beyond SureStart Protection

If CertainTeed determines its shingles are defective after the SureStart period, CertainTeed's maximum contribution toward the cost of repairing or replacing defective shingles will be calculated using the reasonable cost of comparable replacement shingles as determined by CertainTeed less the Reduction Figure Per Month, specified in Table 1, for the number of months from the start of the warranty period to the date when CertainTeed determines the shingles are defective. Labor costs, roof tear-off, metal work, flashing and disposal expenses, and other costs or expenses incurred during such repair or replacement are not covered or reimbursed by this Limited Warranty.

TABLE 1

<u>Lifetime Products^A</u>	<u>Warranty Period</u>	<u>SureStart Period</u>	<u>Wind Warranty Miles Per Hour</u>	<u>Algae Resistant Warranty Period¹</u>	<u>Reduction Figure Per Month</u>
Grand Manor™ Presidential Shake™ TL Presidential Solaris™ Landmark™ TL Presidential Shake™ (& IR) ² Carriage House™ Landmark™ Premium Landmark Solaris™ (& IR) ² Landmark™ PRO Highland Slate™ (& IR) ² Independence™	Lifetime ^A	10 Years	110 ^{††}	15	1/600*
<u>Lifetime Products^B</u>	<u>Warranty Period</u>	<u>SureStart Period</u>	<u>Wind Warranty Miles Per Hour</u>	<u>Algae Resistant Warranty Period¹</u>	<u>Reduction Figure Per Month</u>
Landmark™ IR ² Landmark™ Hatteras®	Lifetime ^B	10 Years	110 ^{††}	10	1/600*
<u>20 -, 25 - and 30 - Year Products</u>	<u>Warranty Period</u>	<u>SureStart Period</u>	<u>Wind Warranty Miles Per Hour</u>	<u>Algae Resistant Warranty Period¹</u>	<u>Reduction Figure Per Month</u>
XT 30™ (& IR) ²	30 Years	5 Years	70 ^{†††}	10	1/360
XT 25™	25 Years	5 Years	60	10	1/300
CT 20™	20 Years	3 Years	60	10	1/240
Any shingles applied to any inadequately ventilated roof deck	10 years [†]	N/A	N/A	N/A	1/120

A. The Lifetime Warranty period is only available to individual homeowners. The warranty period for these shingles installed on premises not used by individual homeowners as their residence is limited to 50 years and the SureStart period is 10 years following the installation of the shingles. Roof tear-off and disposal expense, incurred during repair or replacement are covered or reimbursed by this Limited Warranty. Limited Warranty transferees during the SureStart period are limited to a 50-year warranty period (see section titled "Transfers During the SureStart Period" for details).

B. The Lifetime Warranty period is only available to individual homeowners. The warranty period for these shingles installed on premises not used by individual homeowners as their residence is limited to 40 years and the SureStart period is 5 years following the installation of the shingles. Limited Warranty transferees during the SureStart period are limited to a 40-year warranty period (see section titled "Transfers During the SureStart Period" for details).

* For Lifetime products, at the completion of the 40th year the reduction figure will remain at 480/600, or 20% of the total maximum liability.

† For details of warranty coverage for shingles installed on inadequately ventilated roof decks on both residential and commercial buildings, see provisions under "Inadequately Ventilated and Non-Ventilated Decks."

†† Wind warranty upgrade – These products are warranted to resist blow-off due to wind velocities, including gusts, up to a maximum of 130 miles per hour during the first fifteen (15) years, provided all of the following conditions are met:

1. The CertainTeed shingles are not applied over existing roof shingles (roof-overs are not permitted).
2. The CertainTeed specified corresponding hip and ridge accessory products are installed as cap shingles (Shadow Ridge™, Cedar Crest™, Shangle Ridge™, Mountain Ridge™ Landmark Solaris™ (& IR) and Hatteras®).
3. The CertainTeed specified corresponding starter shingles are installed along the roof eaves and rakes (Swiftstart™, High-Performance Starter and Presidential Starter).

(Note: In Florida, CertainTeed will waive the requirement of applying starter shingles along the roof rake if all of the following conditions are met: The applicable building code requires that asphalt roof shingles be embedded in an 8-inch-wide bed of asphalt roofing cement applied along the roof rake edges. And, the shingles are installed and embedded in an 8-inch-wide bed of asphalt roofing cement along the roof rake edges in accordance with the code.)

††† The Wind warranty for XT 30 (& IR) for the Northwest region is 80 mph. The Wind warranty is 100 mph in Hawaii and Alaska only.

¹Algae Resistant Warranty period applies only to the Algae Resistant (AR) version of the pertinent shingle.

²CertainTeed's Impact Resistant (IR) versions of Landmark™, Presidential Shake™, Highland Slate™, Landmark Solaris™, and XT™ 30 shingles comply with UL 2218 Impact Resistance of Prepared Roof Covering Materials test criteria at time of manufacture.

Transferability

This Limited Warranty is transferable, but only by the original property owner/consumer to the first subsequent property owner. After the Limited Warranty has been transferred once, it is no longer transferable. The warranty transfer is only effective if the subsequent property owner provides written notice of the transfer to CertainTeed within sixty (60) days from the real estate title transfer date. (Notice must be sent to CertainTeed Roofing Technical Services Department, 1400 Union Meeting Road, Blue Bell, PA 19422.)

Transfers During the SureStart Period

If this Limited Warranty is properly transferred during the product's SureStart period, the warranty for the new owner is the same as it would have been for the original owner, except for certain products with Lifetime warranty periods where the duration of the transferred warranty will be 50 years or 40 years as specified in Table 1, measured from the beginning of the SureStart period (i.e. the date of installation), and the remaining period of SureStart protection will be available to the subsequent property owner.

Transfers After the SureStart Period

If this Limited Warranty is properly transferred by the original property owner/consumer after the SureStart period, the warranty following the transfer will be limited to two (2) years from the date of real estate title transfer. The warranty obligation will be calculated as explained in the section titled "Beyond SureStart Protection."

Limitations

This Limited Warranty does not provide protection against, and CertainTeed will have no liability for, any failure, defect or damage caused by situations and events beyond normal exposure conditions, including but not limited to:

- Winds, including gusts, greater than the Wind Warranty MPH in Table 1.
- Damage caused by lightning, hailstorm, earthquake, fire, explosion, flood or falling objects.
- Damage caused by tornado, or hurricanes (other than as warranted under Wind Warranty MPH in Table 1).
- Distortion, cracking or other failure or movement of: the base material over which the shingles are applied, the roof deck, or the walls or foundation of the building itself.
- Damage caused by structural changes, alterations or additions, or by the installation of equipment (such as, but not limited to, aerials, signs or air-conditioning equipment) to the building after the original shingles have been applied.
- Shading, stains or discoloration to the shingles arising from outside sources such as, but not limited to, algae (unless blue-green algae as described in the section titled "Limited Algae Warranty"), fungus, moss, lichens or other vegetation, mold or mildew growth, or paints, chemicals or other similar materials.
- Misuse, abuse, neglect, or improper transportation, handling or storage of the shingles.
- Installation of the shingles over non-approved roof decks as more fully explained in CertainTeed's installation instructions published at the time of original installation.

- Damage caused by improper installation or installation not in accordance with CertainTeed's installation instructions published at the time of original installation.
- Damage to the shingles, the roof deck or the structure caused by ice backup or ice damming.
- Vandalism or acts of war.
- Any other cause not a result of a manufacturing defect in the shingles.

Mold and mildew are functions of environmental conditions and are not manufacturing defects. As such, mold and mildew are not covered by this Limited Warranty or any implied warranty. CertainTeed reserves the right to discontinue or modify any of its products, including the color of its shingles, and shall not be liable as a result of such discontinuance or modification, nor shall CertainTeed be liable in the event replacement material varies in color in comparison to the original product as a result of normal weathering. If CertainTeed replaces any material under this warranty, it may substitute products designated by CertainTeed to be of comparable quality or price range in the event the product initially installed has been discontinued or modified.

Inadequately Ventilated and Non-Ventilated Decks

Any shingles applied to inadequately ventilated or non-ventilated decks, other than the shingles and deck systems described in the section titled "Insulated Decks and Radiant Barriers," are subject to a reduced limited warranty period of ten (10) years and do not qualify for SureStart Protection. SureStart Protection and the Warranty Period applicable to the shingle are available if CertainTeed determines that the shingle damage was caused exclusively by a manufacturing defect that is unrelated to the inadequate roof system ventilation.

Insulated Decks and Radiant Barriers

CertainTeed's Limited Warranty, including SureStart Protection, will remain in force when its fiber glass shingles are applied to roof deck assemblies where foam insulation is prefabricated into the roof deck system (often called "nailboard insulation"), where insulation is installed beneath an acceptable roof deck system, or where radiant barriers are installed, with or without ventilation, directly below the deck. Acceptable roof deck surfaces must consist of at least 3/8" thick plywood or 7/16" thick Oriented Strand Board (OSB) and slopes must be 2:12 or greater. If a different deck surface material will be utilized, please contact CertainTeed's Technical Services Department for assistance. (See the following important restrictions.)

The design professional is responsible for ensuring: 1) the proper quality and application of the insulation and/or radiant barrier, 2) the provision of adequate structural ventilation and/or vapor retarders as determined to be necessary, and 3) that all local codes are met (particularly taking into account local climate conditions). Special attention must be taken if cellular foam, fiber glass, cellulose insulation or other highly permeable insulation will be used in an unventilated system, or if the insulation/rafter or insulation/joist planes may create an air leak that could lead to moisture transmission and condensation problems. All these important factors and decisions, while not the responsibility of CertainTeed, are critical to assure proper deck system performance.

Ventilated Nail-Base Roof Insulation

Ventilated Nail-Base Roof Insulation products (e.g. Flint Board™ CV) are made of rigid insulation (typically foam board) and another layer of material that provides air space above the insulation and below the nailable deck (which is typically at least 7/16" thick OSB or 3/8" thick plywood). These products can provide soffit-to-ridge ventilation, and if installed in accordance with the deck manufacturer's instructions to achieve sufficient ventilation, will not reduce the scope or length of CertainTeed's Limited Warranty coverage.

Limited Algae Warranty

Blue-green algae, which is commonly but incorrectly called "fungus," can create unsightly streaking on shingles. CertainTeed warrants that the Algae-Resistant (AR) versions of the products in Table 1 will remain free from blue-green algae growth (but not mold or mildew growth) which adversely affects the overall appearance of said shingles for a period of ten (10) or fifteen (15) years, as noted in Table 1.

If during the Algae-Resistant Warranty Period specified in Table 1, the overall appearance of the Algae-Resistant shingles is adversely affected by blue-green algae, CertainTeed will pay the reasonable cost to replace or clean at its option, any affected shingles. In the event of replacement or cleaning, for the remainder of the Algae-Resistant Warranty Period,

CertainTeed's maximum contribution towards subsequent replacement or cleaning will be calculated using the Algae-Resistant Warranty Period specified in Table 1, less a prorated adjustment that reflects the number of months that have elapsed from the start of the Algae-Resistant Warranty Period to the date of reoccurrence.

WARNING: FOR LOW-VOLUME RAIN AND SALT FOG AREAS

In areas of low-volume rain (e.g. areas that receive insignificant rainfall during a 90-day period) and/or "salt fog" (e.g. parts of the Southern California coastline), copper released by algae-resistant (AR) granules or shingles can react with aluminum in gutters and cause severe corrosion of the gutters. In such regions, CertainTeed strongly recommends that vinyl or copper gutters, not aluminum gutters, be used with algae-resistant shingles. CertainTeed disclaims all liability and responsibility for any damages that may result from the use of its algae-resistant shingle products with copper granules where gutters containing aluminum are used.

Limited Wind Warranty

CertainTeed warrants its shingles will resist blow-off damage due to wind velocities, including gusts, up to the maximum wind velocity per the Wind Warranty MPH specified in Table 1 during the first fifteen (15) years of the warranty for Lifetime products and during the first five (5) years for all other products listed in Table 1.

CertainTeed's obligations and liability for shingle blow-off damage during the wind warranty periods as specified above are limited as follows:

- If shingles blow off because the shingle's self-sealing asphalt strips did not activate, CertainTeed will have no liability or warranty obligation unless CertainTeed is afforded the opportunity to hand seal, at its expense, any non-sealing shingles.
- If shingles blow off even though the shingle's self-sealing asphalt strips did activate, CertainTeed will furnish replacement shingles without charge, but only for damaged or blown off shingles. CertainTeed will not be responsible for or reimburse labor costs, roof tear-off, metal work, flashing and disposal expenses, or any other costs pertaining to removal or replacement of damaged shingles. Any costs in excess of CertainTeed's material contribution are the property owner's responsibility (and may be covered by homeowner's insurance).
- CertainTeed shall have no liability for any shingles not fastened in accordance with CertainTeed installation instructions published at the time of original installation.
- CertainTeed shall have no liability for any damage to persons or property caused by blown off shingles.
- CertainTeed's maximum liability during the wind warranty period is the reasonable cost of hand sealing all of the shingles on the roof.

Flintlastic™ SA (Self-Adhering) System

For low slope residential roofing projects less than 2000 square feet (20 squares), CertainTeed offers a limited roof membrane warranty as follows: A 10-year warranty duration on a single ply of Flintlastic SA Cap sheet over a primed plywood roof deck or a 12-year warranty duration for a two-ply system consisting of a Flintlastic SA Nail Base and a Flintlastic SA Cap sheet, provided the Flintlastic products were applied in accordance with CertainTeed's current installation instructions published at the time of installation.

CertainTeed warrants the roof membrane, subject to the following terms, conditions, limitations, and exclusions, for the duration specified above from the date of completion of the roof membrane installation. If during the duration of this Limited Warranty, a manufacturing defect in the roof membrane causes a leak, CertainTeed or its designated roofing contractor will, at CertainTeed's sole discretion, repair or replace the roof membrane materials only as necessary to restore it to a watertight condition.

Only manufacturing defects in the roof membrane that cause leaks are covered by this Limited Warranty. CertainTeed's MAXIMUM LIABILITY during the first year of this warranty is the original cost of the CertainTeed membrane materials only. After the first year, CertainTeed's maximum liability is the original cost of the CertainTeed materials used on the roof reduced by 8.3% for 12-year warranty and 10% for 10-year warranty during each subsequent year, less any costs previously incurred by CertainTeed for repair or replacements.

Roof components which are not part of the roof membrane and hence not covered by this Limited Warranty include, but are not limited to, the following: underlying roof deck, insulation, vapor retarders, fasteners, metal work, drains, pitch pans, expansion joints, skylights, vents,

plastic accessories, any flashing, decorative or reflective coating, surfacing and/or any aggregates. In no event, however, will CertainTeed be responsible for any costs related to the removal or abatement of any asbestos present in any existing roof system to which the CertainTeed roof membrane is applied.

What the Customer Must Do

If you believe your shingles have a manufacturing defect, you must promptly notify CertainTeed and provide proof of property ownership and the date of shingle purchase and application. Unless you provide such proof, CertainTeed will use the date of manufacture to calculate the start of the warranty period. In order to properly evaluate and process a warranty claim, CertainTeed may require the property owner to submit a shingle sample to CertainTeed for analysis and/or permit a CertainTeed representative to make repairs to, take photographs of, and/or take samples from the roof, if required. CertainTeed will evaluate each properly reported claim and will repair, replace, clean or reimburse the property owner for the shingles it determines are defective, in accordance with the terms of this Limited Warranty within a reasonable amount of time. For more details about submitting a warranty claim, visit www.ctroof.com or call (800) 345-1145.

Please send all notifications and correspondence to:

CertainTeed Corporation, 1400 Union Meeting Rd., P.O. Box 1100, Blue Bell, PA 19422, Attn: CertainTeed Roofing Technical Services Department. Telephone number: 800-345-1145.

Warranty Registration (not required)

You may register your product warranty on CertainTeed's website:

www.certainteed.com/warrantyreg. Each registrant receives a registration confirmation number by return e-mail that can be printed and kept with this Limited Warranty and your proof of purchase. If you do not have internet access, you can register your shingles by sending: (1) your name, address, and telephone number; (2) the name and contact information of the contractor who installed your shingles and the original date of installation; and, (3) the type, color and number of squares of your shingles to: **CertainTeed Corporation, 1400 Union Meeting Rd., P.O. Box 1100, Blue Bell, PA 19422, Attn: CertainTeed Roofing Technical Services Department.**

CertainTeed will register your information and mail you a confirmation number.

Failure to register this warranty does NOT void the warranty or any of its terms.

For Your Records

Product Purchased: _____ Date of Installation: _____

Roofing Contractor: _____ Contractor's Telephone No. _____

This warranty applies to shingles installed during the calendar year of 2012.

(The warranty in effect at the time the material is originally installed is the applicable warranty.)

Limited Warranty and Limitation of Remedies

THIS DOCUMENT CONSTITUTES THE EXCLUSIVE WARRANTIES AND REMEDIES PROVIDED BY CERTAINTEED. THE WARRANTIES AND REMEDIES CONTAINED IN THIS DOCUMENT ARE EXPRESSLY IN LIEU OF ANY AND ALL OTHER OBLIGATIONS, GUARANTEES AND WARRANTIES, WHETHER WRITTEN, ORAL OR IMPLIED BY STATUTE OR AT LAW. STATE OR PROVINCIAL LAW WILL DETERMINE THE PERIOD OF TIME FOLLOWING THE SALE THAT A PROPERTY OWNER MAY SEEK A REMEDY UNDER THE IMPLIED WARRANTY OF MERCHANTABILITY OR FITNESS FOR A PARTICULAR PURPOSE.

CERTAINTEED'S OBLIGATIONS, RESPONSIBILITIES, AND LIABILITY SHALL BE LIMITED TO REPAIRING OR REPLACING THE DEFECTIVE PRODUCT OR CLEANING ALGAE-RESISTANT SHINGLES IN THE CASE OF ALGAE GROWTH AS SET FORTH IN THIS LIMITED WARRANTY. IN NO EVENT SHALL CERTAINTEED BE LIABLE FOR ANY SPECIAL, INDIRECT, INCIDENTAL OR CONSEQUENTIAL DAMAGES OF ANY KIND, INCLUDING ANY DAMAGE TO THE PROPERTY, THE BUILDING OR ITS CONTENTS, OR FOR INJURY TO ANY PERSONS, THAT MAY OCCUR AS A RESULT OF THE USE OF CERTAINTEED'S PRODUCTS OR AS A RESULT OF THE BREACH OF THIS WARRANTY. IF YOUR STATE OR PROVINCE DOES NOT ALLOW EXCLUSIONS OR LIMITATIONS OF SPECIAL, INDIRECT, INCIDENTAL OR CONSEQUENTIAL DAMAGES, THE ABOVE LIMITATIONS MAY NOT APPLY TO YOU.

IN NO EVENT SHALL CERTAINTEED'S TOTAL LIABILITY ARISING OUT OF OR RELATED TO THE PRODUCT(S) OR THIS LIMITED WARRANTY EXCEED THE REASONABLE COST OF SHINGLES AND LABOR TO REPLACE OR REPAIR THE DEFECTIVE SHINGLES.

This Limited Warranty may not be modified, altered or expanded by anyone, including product distributors, dealers, sellers and/or CertainTeed field representatives.

This Limited Warranty gives you specific legal rights, and you may also have other rights which vary from State to State, or Province to Province.

Roofing Plants and Regional Sales Office

CertainTeed roofing products are sold by CertainTeed Roofing in nine sales regions. They are manufactured in ten residential roofing plants and one commercial roofing plant. Since the early 1900s, CertainTeed Corporation has been an innovator in the building materials industry and today is a leading manufacturer of building materials including residential and commercial roofing, vinyl and fiber cement siding, vinyl windows, composite decking and railing, fiber glass insulation, vinyl fence, and piping products. The company is headquartered in Valley Forge, Pennsylvania, and employs more than 7,000 employees at approximately 50 manufacturing facilities throughout North America. Continuing the 100-year commitment of "Quality made certain, Satisfaction guaranteed™," CertainTeed remains one of the most trusted names in the industry. More information is available at www.certainteed.com.

This document is also available in Spanish and French.

Call 1-800-782-8777 or go to www.certainteed.com.

Se puede obtener este documento en español. Favor de llamar 1-800-782-8777.

Ce document est disponible en anglais et en espagnol. Composez le 1-800-782-8777.

ASK ABOUT OUR OTHER CERTAINTEED® PRODUCTS AND SYSTEMS

ROOFING • SIDING • TRIM • DECKING • RAILING • FENCE • FOUNDATIONS
GYPSUM • CEILINGS • INSULATION • PIPE

www.certainteed.com <http://blog.certainteed.com>

CertainTeed Corporation
P.O. Box 860 / Valley Forge, PA 19482
Professional: 800-233-8990 / Consumer: 800-782-8777

©1/12 CertainTeed Corporation, Printed in U.S.A.

20-20-3333



CertainTeed

Limited Warranty

Asphalt Shingle Products



CertainTeed
SAINT-GOBAIN

Congratulations... and thank you for your recent purchase of one of the fine products from CertainTeed Roofing. Since 1904, CertainTeed has been producing quality roofing products that provide long-lasting beauty and protection for homes of every size, style and age. For over 100 years, the basis for our name, "Quality made certain, satisfaction guaranteed," has been our ongoing philosophy.

Your CertainTeed roofing warranty fully explains how CertainTeed supports its products with the strongest warranty protection available. It is important that you read the warranty section of this brochure. The warranty lists the specific CertainTeed asphalt shingle products that are covered and the period of time for which they are covered. Take the time to understand how CertainTeed protects your purchase by standing behind our products.

Limited, Prorated and Transferable Warranty

This warranty covers asphalt shingle products listed in Table 1, sold only in the United States of America, its territories and Canada.

What and Who Is Covered and for How Long

CertainTeed warrants to the original property owner/consumer that, when subject to normal and proper use, its shingles will be free from manufacturing defects for the length of time specified in Table 1 and that CertainTeed will pay to repair, replace or clean, at its option, any shingles CertainTeed determines are defective under the terms of this Limited Warranty. In the event of repair, replacement or cleaning pursuant to the terms of this Limited Warranty, the warranty applicable to the original shingles shall apply to the repaired, replaced or cleaned shingles and will extend for the balance of the original warranty period.

The Lifetime warranty period offered for certain shingles in Table 1 is only available to individual homeowners. The warranty period for shingles installed on premises not used by individual homeowners as their residence is limited as specified in Table 1. All other structures and property owners (e.g. corporations, governmental agencies, partnerships, trusts, religious organizations, schools, condominiums, homeowner associations or cooperative housing arrangements, apartment buildings, and any other type of building or premises not owned by individual homeowners) are limited to either a 50-year or 40-year warranty period described in Table 1.

Lifetime means as long as the original individual home owner (or the second owner, if the warranty was properly transferred during the SureStart period) owns the property where the shingles are installed.

SureStart™ Protection

Because CertainTeed roofing products are manufactured to the highest quality standards, we confidently include the additional assurance of SureStart™ protection. SureStart provides the strongest non prorated protection you can get in the vital early years of your new roof.

All of CertainTeed's shingle products are covered by SureStart protection. Under this warranty feature, CertainTeed, at no charge, will pay to repair or replace, at its option, any shingles CertainTeed determines are defective during the SureStart period. Note: Wind warranty and algae warranty are covered separately as described on pages 4 & 5. The SureStart period begins on the date of application and terminates following the period specified in Table 1. CertainTeed's maximum liability under SureStart is equal to the reasonable cost of comparable replacement shingles and labor as determined by CertainTeed to replace or repair the defective shingles. Roof tear-off, metal work, flashing and disposal expenses, and other costs or expenses incurred during such repair or replacement are not covered or reimbursed by this Limited Warranty, except for certain products with Lifetime warranty periods specified in Table 1, for which CertainTeed's maximum liability also includes the cost of roof tear-off and disposal.

In instances in which CertainTeed, under the terms of this warranty, has agreed to pay the reasonable cost of labor required to repair or replace defective shingles, CertainTeed will provide reimbursement only upon receipt of a copy of the contractor's invoice or other written evidence of the completion of such work which CertainTeed, in its sole discretion, deems acceptable.

SureStart protection does not extend to any shingles applied to non-ventilated or inadequately ventilated roof deck systems as determined by CertainTeed, except as stated on page 4. CertainTeed's maximum contribution toward the cost of repairing or replacing defective shingles applied to a non-ventilated or inadequately ventilated roof deck system is calculated using the

reasonable cost of comparable replacement shingles as determined by CertainTeed less 1/120th of that amount multiplied by the number of months from the start of the warranty period to the date when CertainTeed determines the shingles are defective. Labor costs, roof tear-off, metal work, flashing and disposal expenses, and other costs or expenses incurred during such repair or replacement are not covered or reimbursed by this Limited Warranty.

Beyond SureStart Protection

If CertainTeed determines its shingles are defective after the SureStart period, CertainTeed's maximum contribution toward the cost of repairing or replacing defective shingles will be calculated using the reasonable cost of comparable replacement shingles as determined by CertainTeed less the Reduction Figure Per Month, specified in Table 1, for the number of months from the start of the warranty period to the date when CertainTeed determines the shingles are defective. Labor costs, roof tear-off, metal work, flashing and disposal expenses, and other costs or expenses incurred during such repair or replacement are not covered or reimbursed by this Limited Warranty.

TABLE 1

<u>Lifetime Products^A</u>	<u>Warranty Period</u>	<u>SureStart Period</u>	<u>Wind Warranty Miles Per Hour</u>	<u>Algae Resistant Warranty Period[†]</u>	<u>Reduction Figure Per Month</u>
Grand Manor™ Presidential Shake™ TL Presidential Solaris™ Landmark™ TL Presidential Shake™ (& IR) ² Carriage House™ Landmark™ Premium Landmark Solaris™ (& IR) ² Landmark™ PRO Highland Slate™ (& IR) ² Independence™	Lifetime ^A	10 Years	110 ^{††}	15	1/600*
<u>Lifetime Products^B</u>	<u>Warranty Period</u>	<u>SureStart Period</u>	<u>Wind Warranty Miles Per Hour</u>	<u>Algae Resistant Warranty Period[†]</u>	<u>Reduction Figure Per Month</u>
Landmark™ IR ² Landmark™ Hatteras®	Lifetime ^B	10 Years	110 ^{††}	10	1/600*
<u>20 -, 25 - and 30 - Year Products</u>	<u>Warranty Period</u>	<u>SureStart Period</u>	<u>Wind Warranty Miles Per Hour</u>	<u>Algae Resistant Warranty Period[†]</u>	<u>Reduction Figure Per Month</u>
XT 30™ (& IR) ²	30 Years	5 Years	70 ^{†††}	10	1/360
XT 25™	25 Years	5 Years	60	10	1/300
CT 20™	20 Years	3 Years	60	10	1/240
Any shingles applied to any inadequately ventilated roof deck	10 years [†]	N/A	N/A	N/A	1/120

A. The Lifetime Warranty period is only available to individual homeowners. The warranty period for these shingles installed on premises not used by individual homeowners as their residence is limited to 50 years and the SureStart period is 10 years following the installation of the shingles. Roof tear-off, metal work, flashing and disposal expense, incurred during repair or replacement are covered or reimbursed by this Limited Warranty. Limited Warranty transferees during the SureStart period are limited to a 50-year warranty period (see section titled "Transfers During the SureStart Period" for details).

B. The Lifetime Warranty period is only available to individual homeowners. The warranty period for these shingles installed on premises not used by individual homeowners as their residence is limited to 40 years and the SureStart period is 5 years following the installation of the shingles. Limited Warranty transferees during the SureStart period are limited to a 40-year warranty period (see section titled "Transfers During the SureStart Period" for details).

* For Lifetime products, at the completion of the 40th year the reduction figure will remain at 480/600, or 20% of the total maximum liability.

† For details of warranty coverage for shingles installed on inadequately ventilated roof decks on both residential and commercial buildings, see provisions under "Inadequately Ventilated and Non-Ventilated Decks."

†† Wind warranty upgrade – These products are warranted to resist blow-off due to wind velocities, including gusts, up to a maximum of 130 miles per hour during the first fifteen (15) years, provided all of the following conditions are met:

1. The CertainTeed shingles are not applied over existing roof shingles (roof-overs are not permitted).
2. The CertainTeed specified corresponding hip and ridge accessory products are installed as cap shingles (Shadow Ridge™, Cedar Crest™, Shangle Ridge™, Mountain Ridge™ Landmark Solaris™ (& IR) and Hatteras™).
3. The CertainTeed specified corresponding starter shingles are installed along the roof eaves and rakes (Swiftstart™, High-Performance Starter and Presidential Starter).

(Note: In Florida, CertainTeed will waive the requirement of applying starter shingles along the roof rake if all of the following conditions are met: The applicable building code requires that asphalt roof shingles be embedded in an 8-inch-wide bed of asphalt roofing cement applied along the roof rake edges. And, the shingles are installed and embedded in an 8-inch-wide bed of asphalt roofing cement along the roof rake edges in accordance with the code.)

††† The Wind warranty for XT 30 (& IR) for the Northwest region is 80 mph. The Wind warranty is 100 mph in Hawaii and Alaska only.

¹Algae Resistant Warranty period applies only to the Algae Resistant (AR) version of the pertinent shingle.

²CertainTeed's Impact Resistant (IR) versions of Landmark™, Presidential Shake™, Highland Slate™, Landmark Solaris™, and XT™ 30 shingles comply with UL 2218 Impact Resistance of Prepared Roof Covering Materials test criteria at time of manufacture.

Transferability

This Limited Warranty is transferable, but only by the original property owner/consumer to the first subsequent property owner. After the Limited Warranty has been transferred once, it is no longer transferable. The warranty transfer is only effective if the subsequent property owner provides written notice of the transfer to CertainTeed within sixty (60) days from the real estate title transfer date. (Notice must be sent to CertainTeed Roofing Technical Services Department, 1400 Union Meeting Road, Blue Bell, PA 19422.)

Transfers During the SureStart Period

If this Limited Warranty is properly transferred during the product's SureStart period, the warranty for the new owner is the same as it would have been for the original owner, except for certain products with Lifetime warranty periods where the duration of the transferred warranty will be 50 years or 40 years as specified in Table 1, measured from the beginning of the SureStart period (i.e. the date of installation), and the remaining period of SureStart protection will be available to the subsequent property owner.

Transfers After the SureStart Period

If this Limited Warranty is properly transferred by the original property owner/consumer after the SureStart period, the warranty following the transfer will be limited to two (2) years from the date of real estate title transfer. The warranty obligation will be calculated as explained in the section titled "Beyond SureStart Protection."

Limitations

This Limited Warranty does not provide protection against, and CertainTeed will have no liability for, any failure, defect or damage caused by situations and events beyond normal exposure conditions, including but not limited to:

- Winds, including gusts, greater than the Wind Warranty MPH in Table 1.
- Damage caused by lightning, hailstorm, earthquake, fire, explosion, flood or falling objects.
- Damage caused by tornado, or hurricanes (other than as warranted under Wind Warranty MPH in Table 1).
- Distortion, cracking or other failure or movement of: the base material over which the shingles are applied, the roof deck, or the walls or foundation of the building itself.
- Damage caused by structural changes, alterations or additions, or by the installation of equipment (such as, but not limited to, aerials, signs or air-conditioning equipment) to the building after the original shingles have been applied.
- Shading, stains or discoloration to the shingles arising from outside sources such as, but not limited to, algae (unless blue-green algae as described in the section titled "Limited Algae Warranty"), fungus, moss, lichens or other vegetation, mold or mildew growth, or paints, chemicals or other similar materials.
- Misuse, abuse, neglect, or improper transportation, handling or storage of the shingles.
- Installation of the shingles over non-approved roof decks as more fully explained in CertainTeed's installation instructions published at the time of original installation.

- Damage caused by improper installation or installation not in accordance with CertainTeed's installation instructions published at the time of original installation.
- Damage to the shingles, the roof deck or the structure caused by ice backup or ice damming.
- Vandalism or acts of war.
- Any other cause not a result of a manufacturing defect in the shingles.

Mold and mildew are functions of environmental conditions and are not manufacturing defects. As such, mold and mildew are not covered by this Limited Warranty or any implied warranty. CertainTeed reserves the right to discontinue or modify any of its products, including the color of its shingles, and shall not be liable as a result of such discontinuance or modification, nor shall CertainTeed be liable in the event replacement material varies in color in comparison to the original product as a result of normal weathering. If CertainTeed replaces any material under this warranty, it may substitute products designated by CertainTeed to be of comparable quality or price range in the event the product initially installed has been discontinued or modified.

Inadequately Ventilated and Non-Ventilated Decks

Any shingles applied to inadequately ventilated or non-ventilated decks, other than the shingles and deck systems described in the section titled "Insulated Decks and Radiant Barriers," are subject to a reduced limited warranty period of ten (10) years and do not qualify for SureStart Protection. **SureStart Protection and the Warranty Period applicable to the shingle are available if** CertainTeed determines that the shingle damage was caused exclusively by a manufacturing defect that is unrelated to the inadequate roof system ventilation.

Insulated Decks and Radiant Barriers

CertainTeed's Limited Warranty, including SureStart Protection, will remain in force when its fiber glass shingles are applied to roof deck assemblies where foam insulation is prefabricated into the roof deck system (often called "nailboard insulation"), where insulation is installed beneath an acceptable roof deck system, or where radiant barriers are installed, with or without ventilation, directly below the deck. Acceptable roof deck surfaces must consist of at least 3/8" thick plywood or 7/16" thick Oriented Strand Board (OSB) and slopes must be 2:12 or greater. If a different deck surface material will be utilized, please contact CertainTeed's Technical Services Department for assistance. (See the following important restrictions.)

The design professional is responsible for ensuring: 1) the proper quality and application of the insulation and/or radiant barrier, 2) the provision of adequate structural ventilation and/or vapor retarders as determined to be necessary, and 3) that all local codes are met (particularly taking into account local climate conditions). Special attention must be taken if cellular foam, fiber glass, cellulose insulation or other highly permeable insulation will be used in an unventilated system, or if the insulation/rafter or insulation/joist planes may create an air leak that could lead to moisture transmission and condensation problems. All these important factors and decisions, while not the responsibility of CertainTeed, are critical to assure proper deck system performance.

Ventilated Nail-Base Roof Insulation

Ventilated Nail-Base Roof Insulation products (e.g. Flint Board™ CV) are made of rigid insulation (typically foam board) and another layer of material that provides air space above the insulation and below the nailable deck (which is typically at least 7/16" thick OSB or 3/8" thick plywood). These products can provide soffit-to-ridge ventilation, and if installed in accordance with the deck manufacturer's instructions to achieve sufficient ventilation, will not reduce the scope or length of CertainTeed's Limited Warranty coverage.

Limited Algae Warranty

Blue-green algae, which is commonly but incorrectly called "fungus," can create unsightly streaking on shingles. CertainTeed warrants that the Algae-Resistant (AR) versions of the products in Table 1 will remain free from blue-green algae growth (but not mold or mildew growth) which adversely affects the overall appearance of said shingles for a period of ten (10) or fifteen (15) years, as noted in Table 1.

If during the Algae-Resistant Warranty Period specified in Table 1, the overall appearance of the Algae-Resistant shingles is adversely affected by blue-green algae, CertainTeed will pay the reasonable cost to replace or clean at its option, any affected shingles. In the event of replacement or cleaning, for the remainder of the Algae-Resistant Warranty Period,

CertainTeed's maximum contribution towards subsequent replacement or cleaning will be calculated using the Algae-Resistant Warranty Period specified in Table 1, less a prorated adjustment that reflects the number of months that have elapsed from the start of the Algae-Resistant Warranty Period to the date of reoccurrence.

WARNING: FOR LOW-VOLUME RAIN AND SALT FOG AREAS

In areas of low-volume rain (e.g. areas that receive insignificant rainfall during a 90-day period) and/or "salt fog" (e.g. parts of the Southern California coastline), copper released by algae-resistant (AR) granules or shingles can react with aluminum in gutters and cause severe corrosion of the gutters. In such regions, CertainTeed strongly recommends that vinyl or copper gutters, not aluminum gutters, be used with algae-resistant shingles. CertainTeed disclaims all liability and responsibility for any damages that may result from the use of its algae-resistant shingle products with copper granules where gutters containing aluminum are used.

Limited Wind Warranty

CertainTeed warrants its shingles will resist blow-off damage due to wind velocities, including gusts, up to the maximum wind velocity per the Wind Warranty MPH specified in Table 1 during the first fifteen (15) years of the warranty for Lifetime products and during the first five (5) years for all other products listed in Table 1.

CertainTeed's obligations and liability for shingle blow-off damage during the wind warranty periods as specified above are limited as follows:

- If shingles blow off because the shingle's self-sealing asphalt strips did not activate, CertainTeed will have no liability or warranty obligation unless CertainTeed is afforded the opportunity to hand seal, at its expense, any non-sealing shingles.
- If shingles blow off even though the shingle's self-sealing asphalt strips did activate, CertainTeed will furnish replacement shingles without charge, but only for damaged or blown off shingles. CertainTeed will not be responsible for or reimburse labor costs, roof tear-off, metal work, flashing and disposal expenses, or any other costs pertaining to removal or replacement of damaged shingles. Any costs in excess of CertainTeed's material contribution are the property owner's responsibility (and may be covered by homeowner's insurance).
- CertainTeed shall have no liability for any shingles not fastened in accordance with CertainTeed installation instructions published at the time of original installation.
- CertainTeed shall have no liability for any damage to persons or property caused by blown off shingles.
- CertainTeed's maximum liability during the wind warranty period is the reasonable cost of hand sealing all of the shingles on the roof.

Flintlastic™ SA (Self-Adhering) System

For low slope residential roofing projects less than 2000 square feet (20 squares), CertainTeed offers a limited roof membrane warranty as follows: A 10-year warranty duration on a single ply of Flintlastic SA Cap sheet over a primed plywood roof deck or a 12-year warranty duration for a two-ply system consisting of a Flintlastic SA Nail Base and a Flintlastic SA Cap sheet, provided the Flintlastic products were applied in accordance with CertainTeed's current installation instructions published at the time of installation.

CertainTeed warrants the roof membrane, subject to the following terms, conditions, limitations, and exclusions, for the duration specified above from the date of completion of the roof membrane installation. If during the duration of this Limited Warranty, a manufacturing defect in the roof membrane causes a leak, CertainTeed or its designated roofing contractor will, at CertainTeed's sole discretion, repair or replace the roof membrane materials only as necessary to restore it to a watertight condition.

Only manufacturing defects in the roof membrane that cause leaks are covered by this Limited Warranty. CertainTeed's MAXIMUM LIABILITY during the first year of this warranty is the original cost of the CertainTeed membrane materials only. After the first year, CertainTeed's maximum liability is the original cost of the CertainTeed materials used on the roof reduced by 8.3% for 12-year warranty and 10% for 10-year warranty during each subsequent year, less any costs previously incurred by CertainTeed for repair or replacements.

Roof components which are not part of the roof membrane and hence not covered by this Limited Warranty include, but are not limited to, the following: underlying roof deck, insulation, vapor retarders, fasteners, metal work, drains, pitch pans, expansion joints, skylights, vents,

plastic accessories, any flashing, decorative or reflective coating, surfacing and/or any aggregates. In no event, however, will CertainTeed be responsible for any costs related to the removal or abatement of any asbestos present in any existing roof system to which the CertainTeed roof membrane is applied.

What the Customer Must Do

If you believe your shingles have a manufacturing defect, you must promptly notify CertainTeed and provide proof of property ownership and the date of shingle purchase and application. Unless you provide such proof, CertainTeed will use the date of manufacture to calculate the start of the warranty period. In order to properly evaluate and process a warranty claim, CertainTeed may require the property owner to submit a shingle sample to CertainTeed for analysis and/or permit a CertainTeed representative to make repairs to, take photographs of, and/or take samples from the roof, if required. CertainTeed will evaluate each properly reported claim and will repair, replace, clean or reimburse the property owner for the shingles it determines are defective, in accordance with the terms of this Limited Warranty within a reasonable amount of time. For more details about submitting a warranty claim, visit www.ctroof.com or call (800) 345-1145.

Please send all notifications and correspondence to:

**CertainTeed Corporation, 1400 Union Meeting Rd., P.O. Box 1100, Blue Bell, PA 19422,
Attn: CertainTeed Roofing Technical Services Department. Telephone number: 800-345-1145.**

Warranty Registration (not required)

You may register your product warranty on CertainTeed's website:

www.certainteed.com/warrantyreg. Each registrant receives a registration confirmation number by return e-mail that can be printed and kept with this Limited Warranty and your proof of purchase. If you do not have internet access, you can register your shingles by sending: (1) your name, address, and telephone number; (2) the name and contact information of the contractor who installed your shingles and the original date of installation; and, (3) the type, color and number of squares of your shingles to: **CertainTeed Corporation, 1400 Union Meeting Rd., P.O. Box 1100, Blue Bell, PA 19422, Attn: CertainTeed Roofing Technical Services Department.**

CertainTeed will register your information and mail you a confirmation number.

Failure to register this warranty does NOT void the warranty or any of its terms.

For Your Records

Product Purchased: _____ Date of Installation: _____

Roofing Contractor: _____ Contractor's Telephone No. _____

This warranty applies to shingles installed during the calendar year of 2013.

(The warranty in effect at the time the material is originally installed is the applicable warranty.)

Limited Warranty and Limitation of Remedies

THIS DOCUMENT CONSTITUTES THE EXCLUSIVE WARRANTIES AND REMEDIES PROVIDED BY CERTAINTEED. THE WARRANTIES AND REMEDIES CONTAINED IN THIS DOCUMENT ARE EXPRESSLY IN LIEU OF ANY AND ALL OTHER OBLIGATIONS, GUARANTEES AND WARRANTIES, WHETHER WRITTEN, ORAL OR IMPLIED BY STATUTE OR AT LAW. STATE OR PROVINCIAL LAW WILL DETERMINE THE PERIOD OF TIME FOLLOWING THE SALE THAT A PROPERTY OWNER MAY SEEK A REMEDY UNDER THE IMPLIED WARRANTY OF MERCHANTABILITY OR FITNESS FOR A PARTICULAR PURPOSE.

CERTAINTEED'S OBLIGATIONS, RESPONSIBILITIES, AND LIABILITY SHALL BE LIMITED TO REPAIRING OR REPLACING THE DEFECTIVE PRODUCT OR CLEANING ALGAE-RESISTANT SHINGLES IN THE CASE OF ALGAE GROWTH AS SET FORTH IN THIS LIMITED WARRANTY. IN NO EVENT SHALL CERTAINTEED BE LIABLE FOR ANY SPECIAL, INDIRECT, INCIDENTAL OR CONSEQUENTIAL DAMAGES OF ANY KIND, INCLUDING ANY DAMAGE TO THE PROPERTY, THE BUILDING OR ITS CONTENTS, OR FOR INJURY TO ANY PERSONS, THAT MAY OCCUR AS A RESULT OF THE USE OF CERTAINTEED'S PRODUCTS OR AS A RESULT OF THE BREACH OF THIS WARRANTY. IF YOUR STATE OR PROVINCE DOES NOT ALLOW EXCLUSIONS OR LIMITATIONS OF SPECIAL, INDIRECT, INCIDENTAL OR CONSEQUENTIAL DAMAGES, THE ABOVE LIMITATIONS SHALL NOT APPLY TO YOU.

IN NO EVENT SHALL CERTAINTEED'S TOTAL LIABILITY ARISING OUT OF OR RELATED TO THE PRODUCT(S) OR THIS LIMITED WARRANTY EXCEED THE REASONABLE COST OF SHINGLES AND LABOR TO REPLACE OR REPAIR THE DEFECTIVE SHINGLES.

This Limited Warranty may not be modified, altered or expanded by anyone, including product distributors, dealers, sellers and/or CertainTeed field representatives.

This Limited Warranty gives you specific legal rights, and you may also have other rights which vary from State to State, or Province to Province.

Roofing Plants and Regional Sales Office

CertainTeed roofing products are sold by CertainTeed Roofing in nine sales regions. They are manufactured in ten residential roofing plants and one commercial roofing plant. Since the early 1900s, CertainTeed Corporation has been an innovator in the building materials industry and today is a leading manufacturer of building materials including residential and commercial roofing, vinyl and fiber cement siding, vinyl windows, composite decking and railing, fiber glass insulation, vinyl fence, and piping products. The company is headquartered in Valley Forge, Pennsylvania, and employs more than 7,000 employees at approximately 50 manufacturing facilities throughout North America. Continuing the 100-year commitment of "Quality made certain, Satisfaction guaranteed™," CertainTeed remains one of the most trusted names in the industry. More information is available at www.certainteed.com.

This document is also available in Spanish and French.

Call 1-800-782-8777 or go to www.certainteed.com.

Se puede obtener este documento en español. Favor de llamar 1-800-782-8777.

Ce document est disponible en anglais et en espagnol. Composez le 1-800-782-8777.

ASK ABOUT OUR OTHER CERTAINTEED® PRODUCTS AND SYSTEMS

ROOFING • SIDING • TRIM • DECKING • RAILING • FENCE • FOUNDATIONS
GYPSUM • CEILINGS • INSULATION • PIPE

www.certainteed.com <http://blog.certainteed.com>

CertainTeed Corporation

P.O. Box 860 / Valley Forge, PA 19482

Professional: 800-233-8990 / Consumer: 800-782-8777

©1/13 CertainTeed Corporation, Printed in U.S.A.

20-20-3396



CertainTeed

Limited Warranty

Asphalt Shingle Products



CertainTeed
SAINT-GOBAIN

Congratulations... and thank you for your recent purchase of one of the fine products from CertainTeed Roofing. Since 1904, CertainTeed has been producing quality roofing products that provide long-lasting beauty and protection for homes of every size, style and age. For over 100 years, the basis for our name, "Quality made certain, satisfaction guaranteed," has been our ongoing philosophy.

Your CertainTeed roofing warranty fully explains how CertainTeed supports its products with the strongest warranty protection available. It is important that you read the warranty section of this brochure. The warranty lists the specific CertainTeed asphalt shingle products that are covered and the period of time for which they are covered. Take the time to understand how CertainTeed protects your purchase by standing behind our products.

Limited, Prorated and Transferable Warranty

This warranty covers asphalt shingle products listed in Table 1, sold only in the United States of America, its territories and Canada.

What and Who Is Covered and for How Long

CertainTeed warrants to the original property owner/consumer that, when subject to normal and proper use, its shingles will be free from manufacturing defects for the length of time specified in Table 1 and that CertainTeed will pay to repair, replace or clean, at its option, any shingles CertainTeed determines are defective under the terms of this Limited Warranty. In the event of repair, replacement or cleaning pursuant to the terms of this Limited Warranty, the warranty applicable to the original shingles shall apply to the repaired, replaced or cleaned shingles and will extend for the balance of the original warranty period.

The Lifetime warranty period offered for certain shingles in Table 1 is only available to individual homeowners. The warranty period for shingles installed on premises not used by individual homeowners as their residence is limited as specified in Table 1. All other structures and property owners (e.g. corporations, governmental agencies, partnerships, trusts, religious organizations, schools, condominiums, homeowner associations or cooperative housing arrangements, apartment buildings, and any other type of building or premises not owned by individual homeowners) are limited to either a 50-year or 40-year warranty period described in Table 1.

Lifetime means as long as the original individual home owner (or the second owner, if the warranty was properly transferred during the SureStart period) owns the property where the shingles are installed.

SureStart™ Protection

Because CertainTeed roofing products are manufactured to the highest quality standards, we confidently include the additional assurance of SureStart™ protection. SureStart provides the strongest non prorated protection you can get in the vital early years of your new roof.

All of CertainTeed's shingle products are covered by SureStart protection. Under this warranty feature, CertainTeed, at no charge, will pay to repair or replace, at its option, any shingles CertainTeed determines are defective during the SureStart period. Note: Wind warranty and algae warranty are covered separately as described on pages 4 & 5. The SureStart period begins on the date of application and terminates following the period specified in Table 1. CertainTeed's maximum liability under SureStart is equal to the reasonable cost of comparable replacement shingles and labor as determined by CertainTeed to replace or repair the defective shingles. Roof tear-off, metal work, flashing and disposal expenses, and other costs or expenses incurred during such repair or replacement are not covered or reimbursed by this Limited Warranty, except for certain products with Lifetime warranty periods specified in Table 1, for which CertainTeed's maximum liability also includes the cost of roof tear-off and disposal.

In instances in which CertainTeed, under the terms of this warranty, has agreed to pay the reasonable cost of labor required to repair or replace defective shingles, CertainTeed will provide reimbursement only upon receipt of a copy of the contractor's invoice or other written evidence of the completion of such work which CertainTeed, in its sole discretion, deems acceptable.

SureStart protection does not extend to any shingles applied to non-ventilated or inadequately ventilated roof deck systems as determined by CertainTeed, except as stated on page 4. CertainTeed's maximum contribution toward the cost of repairing or replacing defective shingles applied to a non-ventilated or inadequately ventilated roof deck system is calculated using the

reasonable cost of comparable replacement shingles as determined by CertainTeed less 1/120th of that amount multiplied by the number of months from the start of the warranty period to the date when CertainTeed determines the shingles are defective. Labor costs, roof tear-off, metal work, flashing and disposal expenses, and other costs or expenses incurred during such repair or replacement are not covered or reimbursed by this Limited Warranty.

Beyond SureStart Protection

If CertainTeed determines its shingles are defective after the SureStart period, CertainTeed's maximum contribution toward the cost of repairing or replacing defective shingles will be calculated using the reasonable cost of comparable replacement shingles as determined by CertainTeed less the Reduction Figure Per Month, specified in Table 1, for the number of months from the start of the warranty period to the date when CertainTeed determines the shingles are defective. Labor costs, roof tear-off, metal work, flashing and disposal expenses, and other costs or expenses incurred during such repair or replacement are not covered or reimbursed by this Limited Warranty.

TABLE 1

<u>Lifetime Products^A</u>	<u>Warranty Period</u>	<u>SureStart Period</u>	<u>Wind Warranty Miles Per Hour</u>	<u>Algae Resistant Warranty Period¹</u>	<u>Reduction Figure Per Month</u>
Grand Manor™ Presidential Shake™ TL Presidential Solaris™ Landmark™ TL Presidential Shake™ (& IR) ² Carriage House™ Landmark™ Premium Landmark Solaris™ (& IR) ² Landmark™ PRO Highland Slate™ (& IR) ² Independence™	Lifetime ^A	10 Years	110 ^{††}	15	1/600*
<u>Lifetime Products^B</u>	<u>Warranty Period</u>	<u>SureStart Period</u>	<u>Wind Warranty Miles Per Hour</u>	<u>Algae Resistant Warranty Period¹</u>	<u>Reduction Figure Per Month</u>
Landmark™ IR ² Landmark™ Hatteras®	Lifetime ^B	10 Years	110 ^{††}	10	1/600*
<u>20 -, 25 - and 30 - Year Products</u>	<u>Warranty Period</u>	<u>SureStart Period</u>	<u>Wind Warranty Miles Per Hour</u>	<u>Algae Resistant Warranty Period¹</u>	<u>Reduction Figure Per Month</u>
Patriot	30 Years	8 Years	110	10	1/360
XT 30™ (& IR) ²	30 Years	5 Years	70 ^{†††}	10	1/360
XT 25™	25 Years	5 Years	60	10	1/300
CT 20™	20 Years	3 Years	60	10	1/240
Any shingles applied to any inadequately ventilated roof deck	10 years [†]	N/A	N/A	N/A	1/120

A. The Lifetime Warranty period is only available to individual homeowners. The warranty period for these shingles installed on premises not used by individual homeowners as their residence is limited to 50 years and the SureStart period is 10 years following the installation of the shingles. Roof tear-off, metal work, flashing and disposal expense, incurred during repair or replacement are covered or reimbursed by this Limited Warranty. Limited Warranty transferees during the SureStart period are limited to a 50-year warranty period (see section titled "Transfers During the SureStart Period" for details).

B. The Lifetime Warranty period is only available to individual homeowners. The warranty period for these shingles installed on premises not used by individual homeowners as their residence is limited to 40 years and the SureStart period is 5 years following the installation of the shingles. Limited Warranty transferees during the SureStart period are limited to a 40-year warranty period (see section titled "Transfers During the SureStart Period" for details).

* For Lifetime products, at the completion of the 40th year the reduction figure will remain at 480/600, or 20% of the total maximum liability.

† For details of warranty coverage for shingles installed on inadequately ventilated roof decks on both residential and commercial buildings, see provisions under "Inadequately Ventilated and Non-Ventilated Decks."

†† Wind warranty upgrade – These products are warranted to resist blow-off due to wind velocities, including gusts, up to a maximum of 130 miles per hour during the first fifteen (15) years, provided all of the following conditions are met:

1. The CertainTeed shingles are not applied over existing roof shingles (roof-overs are not permitted).
2. The CertainTeed specified corresponding hip and ridge accessory products are installed as cap shingles (Shadow Ridge™, Cedar Crest™, Shangle Ridge™, Mountain Ridge™ Landmark Solaris™ (& IR) and Hatteras™).
3. The CertainTeed specified corresponding starter shingles are installed along the roof eaves and rakes (Swiftstart™, High-Performance Starter and Presidential Starter).

(Note: In Florida, CertainTeed will waive the requirement of applying starter shingles along the roof rake if all of the following conditions are met: The applicable building code requires that asphalt roof shingles be embedded in an 8-inch-wide bed of asphalt roofing cement applied along the roof rake edges. And, the shingles are installed and embedded in an 8-inch-wide bed of asphalt roofing cement along the roof rake edges in accordance with the code.)

††† The Wind warranty for XT 30 (& IR) for the Northwest region is 80 mph. The Wind warranty is 100 mph in Hawaii and Alaska only.

¹Algae Resistant Warranty period applies only to the Algae Resistant (AR) version of the pertinent shingle.

²CertainTeed's Impact Resistant (IR) versions of Landmark™, Presidential Shake™, Highland Slate™, Landmark Solaris™, and XT™30 shingles comply with UL 2218 Impact Resistance of Prepared Roof Covering Materials test criteria at time of manufacture.

Transferability

This Limited Warranty is transferable, but only by the original property owner/consumer to the first subsequent property owner. After the Limited Warranty has been transferred once, it is no longer transferable. The warranty transfer is only effective if the subsequent property owner provides written notice of the transfer to CertainTeed within sixty (60) days from the real estate title transfer date. (Notice must be sent to CertainTeed Roofing Technical Services Department, 1400 Union Meeting Road, Blue Bell, PA 19422.)

Transfers During the SureStart Period

If this Limited Warranty is properly transferred during the product's SureStart period, the warranty for the new owner is the same as it would have been for the original owner, except for certain products with Lifetime warranty periods where the duration of the transferred warranty will be 50 years or 40 years as specified in Table 1, measured from the beginning of the SureStart period (i.e. the date of installation), and the remaining period of SureStart protection will be available to the subsequent property owner.

Transfers After the SureStart Period

If this Limited Warranty is properly transferred by the original property owner/consumer after the SureStart period, the warranty following the transfer will be limited to two (2) years from the date of real estate title transfer. The warranty obligation will be calculated as explained in the section titled "Beyond SureStart Protection."

Limitations

This Limited Warranty does not provide protection against, and CertainTeed will have no liability for, any failure, defect or damage caused by situations and events beyond normal exposure conditions, including but not limited to:

- Winds, including gusts, greater than the Wind Warranty MPH in Table 1.
- Damage caused by lightning, hailstorm, earthquake, fire, explosion, flood or falling objects.
- Damage caused by tornado, or hurricanes (other than as warranted under Wind Warranty MPH in Table 1).
- Distortion, cracking or other failure or movement of: the base material over which the shingles are applied, the roof deck, or the walls or foundation of the building itself.
- Damage caused by structural changes, alterations or additions, or by the installation of equipment (such as, but not limited to, aerials, signs or air-conditioning equipment) to the building after the original shingles have been applied.
- Shading, stains or discoloration to the shingles arising from outside sources such as, but not limited to, algae (unless blue-green algae as described in the section titled "Limited Algae Warranty"), fungus, moss, lichens or other vegetation, mold or mildew growth, or paints, chemicals or other similar materials.
- Misuse, abuse, neglect, or improper transportation, handling or storage of the shingles.
- Installation of the shingles over non-approved roof decks as more fully explained in CertainTeed's installation instructions published at the time of original installation.

- Damage caused by improper installation or installation not in accordance with CertainTeed's installation instructions published at the time of original installation.
- Damage to the shingles, the roof deck or the structure caused by ice backup or ice damming.
- Vandalism or acts of war.
- Any other cause not a result of a manufacturing defect in the shingles.

Mold and mildew are functions of environmental conditions and are not manufacturing defects. As such, mold and mildew are not covered by this Limited Warranty or any implied warranty. CertainTeed reserves the right to discontinue or modify any of its products, including the color of its shingles, and shall not be liable as a result of such discontinuance or modification, nor shall CertainTeed be liable in the event replacement material varies in color in comparison to the original product as a result of normal weathering. If CertainTeed replaces any material under this warranty, it may substitute products designated by CertainTeed to be of comparable quality or price range in the event the product initially installed has been discontinued or modified.

Inadequately Ventilated and Non-Ventilated Decks

Any shingles applied to inadequately ventilated or non-ventilated decks, other than the shingles and deck systems described in the section titled "Insulated Decks and Radiant Barriers," are subject to a reduced limited warranty period of ten (10) years and do not qualify for SureStart Protection. **SureStart Protection and the Warranty Period applicable to the shingle are available if** CertainTeed determines that the shingle damage was caused exclusively by a manufacturing defect that is unrelated to the inadequate roof system ventilation.

Insulated Decks and Radiant Barriers

CertainTeed's Limited Warranty, including SureStart Protection, will remain in force when its fiber glass shingles are applied to roof deck assemblies where foam insulation is prefabricated into the roof deck system (often called "nailboard insulation"), where insulation is installed beneath an acceptable roof deck system, or where radiant barriers are installed, with or without ventilation, directly below the deck. Acceptable roof deck surfaces must consist of at least 3/8" thick plywood or 7/16" thick Oriented Strand Board (OSB) and slopes must be 2:12 or greater. If a different deck surface material will be utilized, please contact CertainTeed's Technical Services Department for assistance. (See the following important restrictions.)

The design professional is responsible for ensuring: 1) the proper quality and application of the insulation and/or radiant barrier, 2) the provision of adequate structural ventilation and/or vapor retarders as determined to be necessary, and 3) that all local codes are met (particularly taking into account local climate conditions). Special attention must be taken if cellular foam, fiber glass, cellulose insulation or other highly permeable insulation will be used in an unventilated system, or if the insulation/rafter or insulation/joist planes may create an air leak that could lead to moisture transmission and condensation problems. All these important factors and decisions, while not the responsibility of CertainTeed, are critical to assure proper deck system performance.

Ventilated Nail-Base Roof Insulation

Ventilated Nail-Base Roof Insulation products (e.g. Flint Board™ CV) are made of rigid insulation (typically foam board) and another layer of material that provides air space above the insulation and below the nailable deck (which is typically at least 7/16" thick OSB or 3/8" thick plywood). These products can provide soffit-to-ridge ventilation, and if installed in accordance with the deck manufacturer's instructions to achieve sufficient ventilation, will not reduce the scope or length of CertainTeed's Limited Warranty coverage.

Limited Algae Warranty

Blue-green algae, which is commonly but incorrectly called "fungus," can create unsightly streaking on shingles. CertainTeed warrants that the Algae-Resistant (AR) versions of the products in Table 1 will remain free from blue-green algae growth (but not mold or mildew growth) which adversely affects the overall appearance of said shingles for a period of ten (10) or fifteen (15) years, as noted in Table 1.

If during the Algae-Resistant Warranty Period specified in Table 1, the overall appearance of the Algae-Resistant shingles is adversely affected by blue-green algae, CertainTeed will pay the reasonable cost to replace or clean at its option, any affected shingles. In the event of replacement or cleaning, for the remainder of the Algae-Resistant Warranty Period,

CertainTeed's maximum contribution towards subsequent replacement or cleaning will be calculated using the Algae-Resistant Warranty Period specified in Table 1, less a prorated adjustment that reflects the number of months that have elapsed from the start of the Algae-Resistant Warranty Period to the date of reoccurrence.

WARNING: FOR LOW-VOLUME RAIN AND SALT FOG AREAS

In areas of low-volume rain (e.g. areas that receive insignificant rainfall during a 90-day period) and/or "salt fog" (e.g. parts of the Southern California coastline), copper released by algae-resistant (AR) granules or shingles can react with aluminum in gutters and cause severe corrosion of the gutters. In such regions, CertainTeed strongly recommends that vinyl or copper gutters, not aluminum gutters, be used with algae-resistant shingles. CertainTeed disclaims all liability and responsibility for any damages that may result from the use of its algae-resistant shingle products with copper granules where gutters containing aluminum are used.

Limited Wind Warranty

CertainTeed warrants its shingles will resist blow-off damage due to wind velocities, including gusts, up to the maximum wind velocity per the Wind Warranty MPH specified in Table 1 during the first fifteen (15) years of the warranty for Lifetime products and Patriot shingles for the first ten (10) years and during the first five (5) years for all other products listed in Table 1.

CertainTeed's obligations and liability for shingle blow-off damage during the wind warranty periods as specified above are limited as follows:

- If shingles blow off because the shingle's self-sealing asphalt strips did not activate, CertainTeed will have no liability or warranty obligation unless CertainTeed is afforded the opportunity to hand seal, at its expense, any non-sealing shingles.
- If shingles blow off even though the shingle's self-sealing asphalt strips did activate, CertainTeed will furnish replacement shingles without charge, but only for damaged or blown off shingles. CertainTeed will not be responsible for or reimburse labor costs, roof tear-off, metal work, flashing and disposal expenses, or any other costs pertaining to removal or replacement of damaged shingles. Any costs in excess of CertainTeed's material contribution are the property owner's responsibility (and may be covered by homeowner's insurance).
- CertainTeed shall have no liability for any shingles not fastened in accordance with CertainTeed installation instructions published at the time of original installation.
- CertainTeed shall have no liability for any damage to persons or property caused by blown off shingles.
- CertainTeed's maximum liability during the wind warranty period is the reasonable cost of hand sealing all of the shingles on the roof.

Flintlastic™ SA (Self-Adhering) System

For low slope residential roofing projects less than 2000 square feet (20 squares), CertainTeed offers a limited roof membrane warranty as follows: A 10-year warranty duration on a single ply of Flintlastic SA Cap sheet over a primed plywood roof deck or a 12-year warranty duration for a two-ply system consisting of a Flintlastic SA Nail Base and a Flintlastic SA Cap sheet, provided the Flintlastic products were applied in accordance with CertainTeed's current installation instructions published at the time of installation.

CertainTeed warrants the roof membrane, subject to the following terms, conditions, limitations, and exclusions, for the duration specified above from the date of completion of the roof membrane installation. If during the duration of this Limited Warranty, a manufacturing defect in the roof membrane causes a leak, CertainTeed or its designated roofing contractor will, at CertainTeed's sole discretion, repair or replace the roof membrane materials only as necessary to restore it to a watertight condition.

Only manufacturing defects in the roof membrane that cause leaks are covered by this Limited Warranty. CertainTeed's MAXIMUM LIABILITY during the first year of this warranty is the original cost of the CertainTeed membrane materials only. After the first year, CertainTeed's maximum liability is the original cost of the CertainTeed materials used on the roof reduced by 8.3% for 12-year warranty and 10% for 10-year warranty during each subsequent year, less any costs previously incurred by CertainTeed for repair or replacements.

Roof components which are not part of the roof membrane and hence not covered by this Limited Warranty include, but are not limited to, the following: underlying roof deck, insulation, vapor retarders, fasteners, metal work, drains, pitch pans, expansion joints, skylights, vents,

plastic accessories, any flashing, decorative or reflective coating, surfacing and/or any aggregates. In no event, however, will CertainTeed be responsible for any costs related to the removal or abatement of any asbestos present in any existing roof system to which the CertainTeed roof membrane is applied.

What the Customer Must Do

If you believe your shingles have a manufacturing defect, you must promptly notify CertainTeed and provide proof of property ownership and the date of shingle purchase and application. Unless you provide such proof, CertainTeed will use the date of manufacture to calculate the start of the warranty period. In order to properly evaluate and process a warranty claim, CertainTeed may require the property owner to submit a shingle sample to CertainTeed for analysis and/or permit a CertainTeed representative to make repairs to, take photographs of, and/or take samples from the roof, if required. CertainTeed will evaluate each properly reported claim and will repair, replace, clean or reimburse the property owner for the shingles it determines are defective, in accordance with the terms of this Limited Warranty within a reasonable amount of time. For more details about submitting a warranty claim, visit www.ctroof.com or call (800) 345-1145.

Please send all notifications and correspondence to:

**CertainTeed Corporation, 1400 Union Meeting Rd., P.O. Box 1100, Blue Bell, PA 19422,
Attn: CertainTeed Roofing Technical Services Department. Telephone number: 800-345-1145.**

Warranty Registration (not required)

You may register your product warranty on CertainTeed's website:

www.certainteed.com/warrantyreg. Each registrant receives a registration confirmation number by return e-mail that can be printed and kept with this Limited Warranty and your proof of purchase. If you do not have internet access, you can register your shingles by sending: (1) your name, address, and telephone number; (2) the name and contact information of the contractor who installed your shingles and the original date of installation; and, (3) the type, color and number of squares of your shingles to: **CertainTeed Corporation, 1400 Union Meeting Rd., P.O. Box 1100, Blue Bell, PA 19422, Attn: CertainTeed Roofing Technical Services Department.**

CertainTeed will register your information and mail you a confirmation number.

Failure to register this warranty does NOT void the warranty or any of its terms.

For Your Records

Product Purchased: _____ Date of Installation: _____

Roofing Contractor: _____ Contractor's Telephone No. _____

This warranty applies to shingles installed during the calendar year of 2014.

(The warranty in effect at the time the material is originally installed is the applicable warranty.)

Limited Warranty and Limitation of Remedies

THIS DOCUMENT CONSTITUTES THE EXCLUSIVE WARRANTIES AND REMEDIES PROVIDED BY CERTAINTEED. THE WARRANTIES AND REMEDIES CONTAINED IN THIS DOCUMENT ARE EXPRESSLY IN LIEU OF ANY AND ALL OTHER OBLIGATIONS, GUARANTEES AND WARRANTIES, WHETHER WRITTEN, ORAL OR IMPLIED BY STATUTE OR AT LAW. STATE OR PROVINCIAL LAW WILL DETERMINE THE PERIOD OF TIME FOLLOWING THE SALE THAT A PROPERTY OWNER MAY SEEK A REMEDY UNDER THE IMPLIED WARRANTY OF MERCHANTABILITY OR FITNESS FOR A PARTICULAR PURPOSE.

CERTAINTEED'S OBLIGATIONS, RESPONSIBILITIES, AND LIABILITY SHALL BE LIMITED TO REPAIRING OR REPLACING THE DEFECTIVE PRODUCT OR CLEANING ALGAE-RESISTANT SHINGLES IN THE CASE OF ALGAE GROWTH AS SET FORTH IN THIS LIMITED WARRANTY. IN NO EVENT SHALL CERTAINTEED BE LIABLE FOR ANY SPECIAL, INDIRECT, INCIDENTAL OR CONSEQUENTIAL DAMAGES OF ANY KIND, INCLUDING ANY DAMAGE TO THE PROPERTY, THE BUILDING OR ITS CONTENTS, OR FOR INJURY TO ANY PERSONS, THAT MAY OCCUR AS A RESULT OF THE USE OF CERTAINTEED'S PRODUCTS OR AS A RESULT OF THE BREACH OF THIS WARRANTY. IF YOUR STATE OR PROVINCE DOES NOT ALLOW EXCLUSIONS OR LIMITATIONS OF SPECIAL, INDIRECT, INCIDENTAL OR CONSEQUENTIAL DAMAGES, THE ABOVE LIMITATIONS SHALL NOT APPLY TO YOU.

IN NO EVENT SHALL CERTAINTEED'S TOTAL LIABILITY ARISING OUT OF OR RELATED TO THE PRODUCT(S) OR THIS LIMITED WARRANTY EXCEED THE REASONABLE COST OF SHINGLES AND LABOR TO REPLACE OR REPAIR THE DEFECTIVE SHINGLES.

This Limited Warranty may not be modified, altered or expanded by anyone, including product distributors, dealers, sellers and/or CertainTeed field representatives.

This Limited Warranty gives you specific legal rights, and you may also have other rights which vary from State to State, or Province to Province.

Roofing Plants and Regional Sales Office

CertainTeed roofing products are sold by CertainTeed Roofing in nine sales regions. They are manufactured in ten residential roofing plants and one commercial roofing plant. Since the early 1900s, CertainTeed Corporation has been an innovator in the building materials industry and today is a leading manufacturer of building materials including residential and commercial roofing, vinyl and fiber cement siding, vinyl windows, composite decking and railing, fiber glass insulation, vinyl fence, and piping products. The company is headquartered in Valley Forge, Pennsylvania, and employs more than 7,000 employees at approximately 50 manufacturing facilities throughout North America. Continuing the 100-year commitment of "Quality made certain, Satisfaction guaranteed™," CertainTeed remains one of the most trusted names in the industry. More information is available at www.certainteed.com.

This document is also available in Spanish and French.

Call 1-800-782-8777 or go to www.certainteed.com.

Se puede obtener este documento en español. Favor de llamar 1-800-782-8777.

Ce document est disponible en anglais et en espagnol. Composez le 1-800-782-8777.

ASK ABOUT OUR OTHER CERTAINTEED® PRODUCTS AND SYSTEMS

ROOFING • SIDING • TRIM • DECKING • RAILING • FENCE • FOUNDATIONS
GYPSUM • CEILINGS • INSULATION • PIPE

www.certainteed.com <http://blog.certainteed.com>

CertainTeed Corporation

P.O. Box 860 / Valley Forge, PA 19482

Professional: 800-233-8990 / Consumer: 800-782-8777

©1/14 CertainTeed Corporation, Printed in U.S.A.

20-20-3483REV



CertainTeed

2014 Limited Warranty

Symphony™



ASK ABOUT ALL OF OUR OTHER CERTAINTEED® PRODUCTS AND SYSTEMS:

ROOFING • SIDING • TRIM • DECKING • RAILING • FENCE
GYPSUM • CEILINGS • INSULATION

www.certainteed.com <http://blog.certainteed.com>

CertainTeed Corporation
P.O. Box 860
Valley Forge, PA 19482

Professional: 800-233-8990
Consumer: 800-782-8777

© CertainTeed Corporation, Printed in U.S.A.
Code No. 20-20-3067
1/2014



CertainTeed
SAINT-GOBAIN



Symphony™

*Where old-world elegance meets
new-world technology...in perfect harmony*

What the Customer Must Do

If you believe your shingles have a manufacturing defect, you must provide prompt written notification to CertainTeed with proof of the date of purchase and date of shingle application. CertainTeed will investigate each properly reported claim and will repair, replace or reimburse the homeowner for the shingles determined to be defective, in accordance with the terms of this Limited Warranty, within a reasonable amount of time if its inspection of the shingles confirms a manufacturing defect.

Please send all notifications and correspondence to:

CertainTeed Corporation, 1400 Union Meeting Road, Blue Bell, PA 19422

Attn: CertainTeed Roofing Technical Services Department, Telephone number: 800-345-1145

Warranty Registration (not required)

You may register your product warranty on CertainTeed's website: www.certainteed.com/warrantyreg. Each registrant receives a registration confirmation number by return e-mail that can be printed and kept with this Limited Warranty and your proof of purchase. If you do not have internet access, you can register your shingles by sending: (1) your name, address, and telephone number; (2) the name and contact information of the contractor who installed your shingles and the original date of installation; and (3) the type, color and number of squares of your shingles to:

CertainTeed Corporation, CertainTeed Roofing, P.O. Box 860, Valley Forge, PA 19482

CertainTeed will register your information and mail you a confirmation number. Failure to register this warranty does NOT void the warranty or any of its terms.

Roofing Plants and Regional Sales Offices

CertainTeed roofing products are sold by the CertainTeed Corporation in eight sales regions. They are manufactured in ten residential roofing plants and two commercial roofing plants.

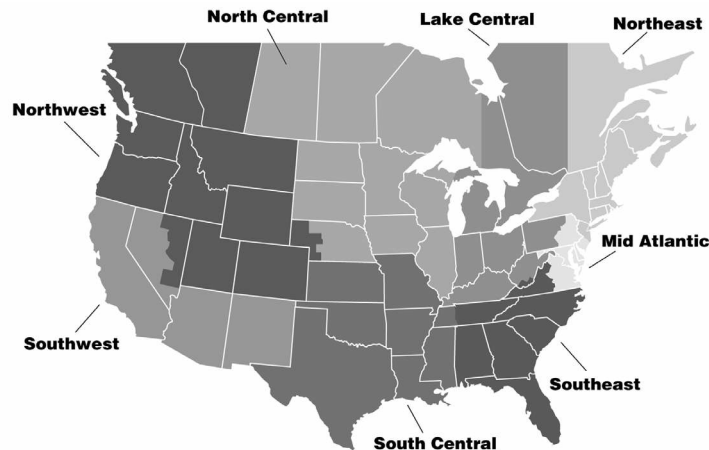

Through innovation and creative product design, CertainTeed has helped shape the building products industry for more than 100 years. Founded in 1904 as General Roofing Manufacturing Company, the firm made its slogan "*Quality made certain. Satisfaction guaranteed.*" which quickly inspired the name CertainTeed. Today, CertainTeed is North America's leading brand of exterior and interior building products, including roofing, siding, windows, fence, decking, railing, trim, foundations, pipe, insulation, walls, ceilings and access covers. Headquarter in Valley Forge, PA, CertainTeed and its affiliates have approximately 9,000 employees and 70 manufacturing facilities throughout the United States and Canada. More information is available at www.certainteed.com.

CONGRATULATIONS! ...and thank you for your recent purchase of one of the fine products produced by CertainTeed Roofing. Since 1904, CertainTeed has been producing quality roofing products that provide long-lasting beauty and protection for homes of every size, style and age. For the past 100 years, the basis for our name, "*Quality made certain, satisfaction guaranteed.*" has been our ongoing philosophy.

Your CertainTeed roofing warranty fully explains how CertainTeed supports its products with the strongest warranty protection available. It is important that you read the warranty section of this brochure.

Take the time to understand how CertainTeed protects your purchase by standing behind our products.

LIMITED, PRORATED, AND TRANSFERABLE WARRANTY

This warranty covers Symphony™ sold only in the United States of America, its territories and Canada.

What and Who is Covered and for How Long

CertainTeed warrants to the original property owner/consumer that, when subject to normal and proper use, Symphony shingles will be free from manufacturing defects that cause leaks for fifty (50) years from the date of original installation and that CertainTeed will pay to repair or replace, at its option, any shingles CertainTeed determines to be defective under the terms of this Limited Warranty.

In the event of repair or replacement pursuant to the terms of this Limited Warranty, the original warranty applicable at the time of original installation shall apply to the replacement shingles or the repaired shingles.

SureStart™ Protection

All of CertainTeed's shingle products are covered by SureStart protection. Under this warranty feature, CertainTeed, at no charge, will pay to repair or replace, at its option, any shingles CertainTeed determines to be defective and that cause leaks during the applicable SureStart period. For Symphony shingles, the SureStart period begins when the original shingle installation has been completed and terminates at the completion of its seventh (7th) year of service following original installation. CertainTeed's maximum liability under SureStart is equal to the reasonable material and labor cost to replace or repair the defective shingles that cause leaks, as determined by CertainTeed. Roof tear-off, metal work, flashing and disposal expenses, and other costs or expenses incurred during such repair or replacement are not covered or reimbursed by this Limited Warranty.

SureStart protection does not extend to any Symphony shingles applied to any non-ventilated or inadequately ventilated roof deck systems, except as stated below. CertainTeed's maximum contribution toward the cost of repairing or replacing defective shingles applied to a non-ventilated or inadequately ventilated roof deck system shall not exceed \$350/square, less 1/120th of that amount times the number of months from the date the shingles were originally installed to the date when CertainTeed determined the shingles to be defective. Labor costs, roof tear-off, metal work, flashing and disposal expenses, and other costs or expenses incurred during such repair or replacement are not covered or reimbursed by this Limited Warranty.

Beyond SureStart™ Protection

If CertainTeed determines the Symphony shingles to be defective and cause leaks after the SureStart period, CertainTeed's maximum contribution toward the cost of repairing or replacing such defective shingles shall not exceed \$350/square, less 1/600th of that amount times the number of months from the date the shingles were originally installed to the date when CertainTeed determined the shingles to be defective. Labor costs, roof tear-off, metal work, flashing and disposal expenses, and other costs or expenses incurred during such repair or replacement are not covered or reimbursed by this Limited Warranty.

Transferability

The Limited Warranty for Symphony shingles may only be transferred by the original property owner/consumer to a subsequent property owner one (1) time in the first two (2) years after original installation. The warranty transfer is only effective if the subsequent property owner provides written notice of the transfer to CertainTeed within sixty (60) days from the real estate transfer date. (A warranty transfer request must be sent to RPG Technical Services Department, 1400 Union Meeting Road, Blue Bell, PA 19422.) After two (2) years, this Limited Warranty is not transferable.

Limitations

This Limited Warranty does not provide protection against and CertainTeed will have no liability for any failure, defect or damage caused by situations and events beyond normal exposure conditions, including but not limited to:

- Winds, including gusts, greater than 90 mph, lightning, hurricane (see "Limited Wind Warranty" section for hurricane wind exception), tornado, hailstorm, earthquake, fire, explosion, flood or falling objects.
- Distortion, cracking or other failure or movement of the base material over which the shingles are applied, of the roof deck, or of the walls or foundation of the building itself.
- Damage caused by structural changes, alterations or additions, or by the installation of equipment (such as aerials, signs or air-conditioning equipment) to the structure after the original shingles have been applied.
- Shading, stains or discoloration to the shingles arising from outside sources such as but not limited to the sun, algae, fungus, moss, lichens or other vegetation, mold or mildew growth, or paints, chemicals or other similar materials.
- Misuse, abuse, neglect, or improper transportation, handling or storage of the shingles.
- Installation of the shingles over non-approved roof decks as more fully explained in the CertainTeed Symphony installation instructions.
- Improper installation or installation not in accordance with CertainTeed's written installation instructions applicable at the time of original installation.
- Damage to the shingles, the roof deck or the structure caused by ice backup or ice damming.
- Distortion or warping due to excessive or unusual heat sources, including without limitation, window reflections and heat buildup caused by inadequate roof ventilation.
- Vandalism or acts of war.
- Any other cause not a result of a manufacturing defect in the shingles.

Mold and mildew are functions of environmental conditions and are not manufacturing defects. As such, mold and mildew are not covered by this Limited Warranty or any implied warranty.

CertainTeed reserves the right to discontinue or modify any of its products, including the color of its shingles, and shall not be liable as a result of such discontinuance or modification, nor shall CertainTeed be liable in the event replacement material varies in color in comparison to the original product as a result of normal weathering. If CertainTeed replaces any material under this warranty, it may substitute products designated by CertainTeed to be of comparable quality or price range in the event the product initially installed has been discontinued or modified.

Inadequately Ventilated and Non-Ventilated Decks

Any shingles applied to inadequately ventilated or non-ventilated decks, other than the shingles and deck systems described in the section titled "Insulated Decks and Radiant Barriers," are subject to a reduced limited warranty period of ten (10) years. Shingle damage or defects related to the absence of adequate roof system ventilation do not qualify for SureStart protection, and are limited to ten (10) years of Beyond SureStart coverage.

Insulated Decks and Radiant Barriers

CertainTeed's Limited Warranty, including SureStart coverage, will remain in force when Symphony shingles are applied to roof deck assemblies (slopes $\geq 3:12$) where foam insulation is prefabricated into the roof deck system (often called "nailboard insulation"), where insulation is installed beneath an acceptable roof deck system, or where radiant barriers are installed, with or without ventilation directly below the deck. Acceptable roof deck surfaces must consist of at least 3/8" thick plywood or 7/16" thick OSB. If a different deck surface material will be utilized, please contact CertainTeed's Technical Services Department for assistance. See the following important restrictions.

The design professional is responsible for ensuring 1) proper quality and application of the insulation and/or radiant barrier; 2) provision of adequate structural ventilation and/or vapor retarders as determined to be necessary, and 3) that all local codes are met (particularly taking into account local climate conditions). Special attention must be taken if cellular foam, fiber glass, cellulose insulations or other highly-permeable insulation will be used in an unventilated system, or if the insulation/rafter or insulation/joist planes may create an air leak that could lead to moisture transmission and condensation problems.

*All these important factors and decisions, while **not** the responsibility of CertainTeed Corporation, are critical to assure proper deck system performance.*

Ventilated Nail-Base Roof Insulation

Ventilated nail-base roof insulation products consist of rigid insulation (typically foam board) and another layer of material that provides air space above the insulation and below the nailable deck (which is typically at least 7/16" thick OSB or minimum 3/8" plywood). These products can provide soffit-to-ridge ventilation over cathedral-type ceilings, and if used and installed properly will not reduce the scope or length of CertainTeed's Limited Warranty coverage period. It is important to follow the deck manufacturer's instructions to achieve sufficient ventilation. CertainTeed offers FlintBoard™ CV – cross-ventilating insulation boards with 1", 1-1/2", or 2" air channels.

Limited Wind Warranty

CertainTeed warrants Symphony shingles to resist blow-off damage due to wind velocities, including gusts and hurricane winds, up to 90 mph during the first five (5) years following original installation.

If any blow-off damage occurs in the first five (5) years following original installation, CertainTeed will replace all damaged shingles without charge. CertainTeed will not be responsible for or reimburse labor costs or any other costs incurred during removal or replacement of damaged shingles. Such costs or damages are the property owner's responsibility (and may be covered by homeowner's insurance).

LIMITED WARRANTY AND LIMITATION OF REMEDIES

THE OBLIGATIONS CONTAINED IN THIS LIMITED WARRANTY CONSTITUTE THE EXCLUSIVE REMEDY AND ARE EXPRESSLY IN LIEU OF ANY AND ALL OTHER OBLIGATIONS, GUARANTEES AND WARRANTIES. APPLICABLE STATE LAW WILL DETERMINE THE PERIOD OF TIME FOLLOWING THE SALE THAT A PROPERTY OWNER/CONSUMER MAY SEEK A REMEDY UNDER THE IMPLIED WARRANTY OF MERCHANTABILITY OR FITNESS FOR A PARTICULAR PURPOSE. CERTAINTEED'S OBLIGATIONS, RESPONSIBILITIES, AND/OR LIABILITY SHALL BE LIMITED TO REPAIRING OR REPLACING THE DEFECTIVE PRODUCT OR PROVIDING A REFUND PER THE TERMS OF THIS LIMITED WARRANTY. IN NO EVENT SHALL CERTAINTEED BE LIABLE FOR ANY INCIDENTAL OR CONSEQUENTIAL DAMAGES, INCLUDING ANY DAMAGE TO THE BUILDING, ITS CONTENTS, OR ANY PERSONS OR PROPERTY, THAT OCCUR AS A RESULT OF A BREACH. IF YOUR STATE DOES NOT ALLOW EXCLUSIONS OR LIMITATIONS OF INCIDENTAL OR CONSEQUENTIAL DAMAGES, THE ABOVE LIMITATIONS MAY NOT APPLY TO YOU.

This warranty applies to Symphony shingles installed during the calendar year of 2014.

This Limited Warranty may not be modified, altered or expanded by anyone, including product distributors, dealers, sellers and/or CertainTeed field representatives. This Limited Warranty gives you specific legal rights, and you may also have other rights which vary from State to State, or Province to Province.

Roofing Plants and Regional Sales Office

CertainTeed roofing products are sold by CertainTeed Roofing in nine sales regions. They are manufactured in ten residential roofing plants and one commercial roofing plant. Since the early 1900s, CertainTeed Corporation has been an innovator in the building materials industry and today is a leading manufacturer of building materials including residential and commercial roofing, vinyl siding, composite decking and railing, fiber glass insulation and vinyl fence products. The company is headquartered in Valley Forge, Pennsylvania, and employs more than 7,000 employees at approximately 50 manufacturing facilities throughout North America. Continuing the 100-year commitment of "Quality made certain, Satisfaction guaranteed™," CertainTeed remains one of the most trusted names in the industry. More information is available at www.certainteed.com.

This document is also available in Spanish and French.

Call 1-800-782-8777 or go to www.certainteed.com.

Se puede obtener este documento en español. Favor de llamar 1-800-782-8777.

Ce document est disponible en anglais et en espagnol. Composez le 1-800-782-8777.

ASK ABOUT OUR OTHER CERTAINTEED® PRODUCTS AND SYSTEMS

ROOFING • SIDING • TRIM • DECKING • RAILING • FENCE
GYPSUM • CEILINGS • INSULATION

www.certainteed.com <http://blog.certainteed.com>

CertainTeed Corporation

P.O. Box 860 / Valley Forge, PA 19482

Professional: 800-233-8990 / Consumer: 800-782-8777

©1/15 CertainTeed Corporation, Printed in U.S.A.

20-20-3541



CertainTeed

Limited Warranty

Asphalt Shingle Products



CertainTeed
SAINT-GOBAIN

Congratulations... and thank you for your recent purchase of one of the fine products from CertainTeed Roofing. Since 1904, CertainTeed has been producing quality roofing products that provide long-lasting beauty and protection for homes of every size, style and age. For over 100 years, the basis for our name, "Quality made certain, satisfaction guaranteed," has been our ongoing philosophy.

Your CertainTeed roofing warranty fully explains how CertainTeed supports its products with the strongest warranty protection available. It is important that you read the warranty section of this brochure. The warranty lists the specific CertainTeed asphalt shingle products that are covered and the period of time for which they are covered. Take the time to understand how CertainTeed protects your purchase by standing behind our products.

Limited, Prorated and Transferable Warranty

This warranty covers asphalt shingle products listed in Table 1, sold only in the United States of America, its territories and Canada.

What and Who Is Covered and for How Long

CertainTeed warrants to the original property owner/consumer that, when subject to normal and proper use, its shingles will be free from manufacturing defects for the length of time specified in Table 1 and that CertainTeed will pay to repair, replace or clean, at its option, any shingles CertainTeed determines are defective under the terms of this Limited Warranty. In the event of repair, replacement or cleaning pursuant to the terms of this Limited Warranty, the warranty applicable to the original shingles shall apply to the repaired, replaced or cleaned shingles and will extend for the balance of the original warranty period.

The Lifetime warranty period offered for certain shingles in Table 1 is only available to individual homeowners. The warranty period for shingles installed on premises not used by individual homeowners as their residence is limited as specified in Table 1. All other structures and property owners (e.g. corporations, governmental agencies, partnerships, trusts, religious organizations, schools, condominiums, homeowner associations or cooperative housing arrangements, apartment buildings, and any other type of building or premises not owned by individual homeowners) are limited to either a 50-year or 40-year warranty period described in Table 1.

Lifetime means as long as the original individual home owner owns the property where the shingles are installed.

SureStart™ Protection

Because CertainTeed roofing products are manufactured to the highest quality standards, we confidently include the additional assurance of SureStart™ protection. SureStart provides the strongest non prorated protection you can get in the vital early years of your new roof.

All of CertainTeed's shingle products are covered by SureStart protection. Under this warranty feature, CertainTeed, at no charge, will pay to repair or replace, at its option, any shingles CertainTeed determines are defective during the SureStart period. Note: Wind warranty and algae warranty are covered separately as described on pages 4 & 5. The SureStart period begins on the date of application and terminates following the period specified in Table 1. CertainTeed's maximum liability under SureStart is equal to the reasonable cost of comparable replacement shingles and labor as determined by CertainTeed to replace or repair the defective shingles. Roof tear-off, metal work, flashing and disposal expenses, and other costs or expenses incurred during such repair or replacement are not covered or reimbursed by this Limited Warranty, except for certain products with Lifetime warranty periods specified in Table 1, for which CertainTeed's maximum liability also includes the cost of roof tear-off and disposal.

In instances in which CertainTeed, under the terms of this warranty, has agreed to pay the reasonable cost of labor required to repair or replace defective shingles, CertainTeed will provide reimbursement only upon receipt of a copy of the contractor's invoice or other written evidence of the completion of such work which CertainTeed, in its sole discretion, deems acceptable.

SureStart protection does not extend to any shingles applied to non-ventilated or inadequately ventilated roof deck systems as determined by CertainTeed, except as stated on page 4.

CertainTeed's maximum contribution toward the cost of repairing or replacing defective shingles applied to a non-ventilated or inadequately ventilated roof deck system is calculated using the reasonable cost of comparable replacement shingles as determined by CertainTeed less 1/120th

of that amount multiplied by the number of months from the start of the warranty period to the date when CertainTeed determines the shingles are defective. Labor costs, roof tear-off, metal work, flashing and disposal expenses, and other costs or expenses incurred during such repair or replacement are not covered or reimbursed by this Limited Warranty.

Beyond SureStart Protection

If CertainTeed determines its shingles are defective after the SureStart period, CertainTeed's maximum contribution toward the cost of repairing or replacing defective shingles will be calculated using the reasonable cost of comparable replacement shingles as determined by CertainTeed less the Reduction Figure Per Month, specified in Table 1, for the number of months from the start of the warranty period to the date when CertainTeed determines the shingles are defective. Labor costs, roof tear-off, metal work, flashing and disposal expenses, and other costs or expenses incurred during such repair or replacement are not covered or reimbursed by this Limited Warranty.

TABLE 1

	Warranty Period	SureStart Period	Wind Warranty Miles Per Hour	Algae Resistant Warranty Period ¹	Reduction Figure Per Month
Lifetime Products*					
Grand Manor® Presidential Shake® TL Presidential Solaris® Landmark® TL Presidential Shake® (& IR) ² Carriage House® Landmark® Premium Landmark Solaris® (& IR) ² Landmark® PRO NorthGate™ Highland Slate® (& IR) ² Independence®	Lifetime*	10 Years	110*	15	1/600*
Lifetime Products*					
Landmark® IR ² Landmark® Hatteras®	Lifetime*	10 Years	110*	10	1/600*
20 -, 25 - and 30 - Year Products					
Patriot®	30 Years	8 Years	110	10	1/360
XT®30 (& IR) ²	30 Years	5 Years	70	10	1/360
XT®25	25 Years	5 Years	60	10	1/300
CT®20	20 Years	3 Years	60	10	1/240
Any shingles applied to any inadequately ventilated roof deck	10 years [†]	N/A	N/A	N/A	1/120

A. The Lifetime Warranty period is only available to individual homeowners. The warranty period for these shingles installed on premises not used by individual homeowners as their residence is limited to 50 years and the SureStart period is 10 years following the installation of the shingles. Roof tear-off, metal work, flashing and disposal expense, incurred during repair or replacement are covered or reimbursed by this Limited Warranty. Limited Warranty transferees during the SureStart period are limited to a 50-year warranty period (see section titled "Transfers During the SureStart Period" for details).

B. The Lifetime Warranty period is only available to individual homeowners. The warranty period for these shingles installed on premises not used by individual homeowners as their residence is limited to 40 years and the SureStart period is 5 years following the installation of the shingles. Limited Warranty transferees during the SureStart period are limited to a 40-year warranty period (see section titled "Transfers During the SureStart Period" for details).

* For Lifetime products, at the completion of the 40th year the reduction figure will remain at 480/600, or 20% of the total maximum liability.

† For details of warranty coverage for shingles installed on inadequately ventilated roof decks on both residential and commercial buildings, see provisions under "Inadequately Ventilated and Non-Ventilated Decks."

†† Wind warranty upgrade – These products are warranted to resist blow-off due to wind velocities, including gusts, up to a maximum of 130 miles per hour during the first fifteen (15) years, provided all of the following conditions are met:

1. The CertainTeed shingles are not applied over existing roof shingles (roof-overs are not permitted).
2. The CertainTeed specified corresponding hip and ridge accessory products are installed as cap shingles (Shadow Ridge™, Cedar Crest™, Shangle Ridge™, Mountain Ridge™ Landmark Solaris® (& IR) and Hatteras®).
3. The CertainTeed specified corresponding starter shingles are installed along the roof eaves and rakes (Swiftstart™, High-Performance Starter and Presidential Starter).

(Note: In Florida, CertainTeed will waive the requirement of applying starter shingles along the roof rake if all of the following conditions are met: The applicable building code requires that asphalt roof shingles be embedded in an 8-inch-wide bed of asphalt roofing cement applied along the roof rake edges. And, the shingles are installed and embedded in an 8-inch-wide bed of asphalt roofing cement along the roof rake edges in accordance with the code.)

¹Algae Resistant Warranty period applies only to the Algae Resistant (AR) version of the pertinent shingle.

²CertainTeed's Impact Resistant (IR) versions of Landmark®, Presidential Shake®, Highland Slate®, Landmark Solaris®, and XT®30 shingles comply with UL 2218 Impact Resistance of Prepared Roof Covering Materials test criteria at time of manufacture.

Transferability

This Limited Warranty is transferable, but only by the original property owner/consumer to the first subsequent property owner. After the Limited Warranty has been transferred once, it is no longer transferable.

Transfers During the SureStart Period

If this Limited Warranty is properly transferred during the product's SureStart period, the warranty for the new owner is the same as it would have been for the original owner, except for certain products with Lifetime warranty periods where the duration of the transferred warranty will be 50 years or 40 years as specified in Table 1, measured from the beginning of the SureStart period (i.e. the date of installation), and the remaining period of SureStart protection will be available to the subsequent property owner.

Transfers After the SureStart Period

If this Limited Warranty is properly transferred by the original property owner/consumer after the SureStart period, the warranty following the transfer will be limited to two (2) years from the date of real estate title transfer. The warranty obligation will be calculated as explained in the section titled "Beyond SureStart Protection."

Limitations

This Limited Warranty does not provide protection against, and CertainTeed will have no liability for, any failure, defect or damage caused by situations and events beyond normal exposure conditions, including but not limited to:

- Winds, including gusts, greater than the Wind Warranty MPH in Table 1.
- Damage caused by lightning, hailstorm, earthquake, fire, explosion, flood or falling objects.
- Damage caused by tornado, or hurricanes (other than as warranted under Wind Warranty MPH in Table 1).
- Distortion, cracking or other failure or movement of: the base material over which the shingles are applied, the roof deck, or the walls or foundation of the building itself.
- Damage caused by structural changes, alterations or additions, or by the installation of equipment (such as, but not limited to, aerials, signs or air-conditioning equipment) to the building after the original shingles have been applied.
- Shading, stains or discoloration to the shingles arising from outside sources such as, but not limited to, algae (unless blue-green algae as described in the section titled "Limited Algae Warranty"), fungus, moss, lichens or other vegetation, mold or mildew growth, or paints, chemicals or other similar materials.
- Misuse, abuse, neglect, or improper transportation, handling or storage of the shingles.
- Installation of the shingles over non-approved roof decks as more fully explained in CertainTeed's installation instructions published at the time of original installation.
- Damage caused by improper installation or installation not in accordance with CertainTeed's installation instructions published at the time of original installation.
- Damage to the shingles, the roof deck or the structure caused by ice backup or ice damming.
- Damage caused by impact, including such things as tools, equipment or foot traffic.

- Vandalism or acts of war.
- Any other cause not a result of a manufacturing defect in the shingles.
- Animals, animal feces or insects.

Mold and mildew are functions of environmental conditions and are not manufacturing defects. As such, mold and mildew are not covered by this Limited Warranty or any implied warranty.

CertainTeed reserves the right to discontinue or modify any of its products, including the color of its shingles, and shall not be liable as a result of such discontinuance or modification, nor shall CertainTeed be liable in the event replacement material varies in color in comparison to the original product as a result of normal weathering. If CertainTeed replaces any material under this warranty, it may substitute products designated by CertainTeed to be of comparable quality or price range in the event the product initially installed has been discontinued or modified.

Inadequately Ventilated and Non-Ventilated Decks

Any shingles applied to inadequately ventilated or non-ventilated decks, other than the shingles and deck systems described in the section titled "Insulated Decks and Radiant Barriers," are subject to a reduced limited warranty period of ten (10) years and do not qualify for SureStart Protection. **SureStart Protection and the Warranty Period applicable to the shingle are available** if CertainTeed determines that the shingle damage was caused exclusively by a manufacturing defect that is unrelated to the inadequate roof system ventilation.

Insulated Decks and Radiant Barriers

CertainTeed's Limited Warranty, including SureStart Protection, will remain in force when its fiber glass shingles are applied to roof deck assemblies where foam insulation is prefabricated into the roof deck system (often called "nailboard insulation"), where insulation is installed beneath an acceptable roof deck system, or where radiant barriers are installed, with or without ventilation, directly below the deck. Acceptable roof deck surfaces must consist of at least 3/8" thick plywood or 7/16" thick Oriented Strand Board (OSB) and slopes must be 2:12 or greater. If a different deck surface material will be utilized, please contact CertainTeed's Technical Services Department for assistance. (See the following important restrictions.)

The design professional is responsible for ensuring: 1) the proper quality and application of the insulation and/or radiant barrier, 2) the provision of adequate structural ventilation and/or vapor retarders as determined to be necessary, and 3) that all local codes are met (particularly taking into account local climate conditions). Special attention must be taken if cellular foam, fiber glass, cellulose insulation or other highly permeable insulation will be used in an unventilated system, or if the insulation/rafter or insulation/joist planes may create an air leak that could lead to moisture transmission and condensation problems. All these important factors and decisions, while not the responsibility of CertainTeed, are critical to assure proper deck system performance.

Ventilated Nail-Base Roof Insulation

Ventilated Nail-Base Roof Insulation products (e.g. FlintBoard® CV) are made of rigid insulation (typically foam board) and another layer of material that provides air space above the insulation and below the nailable deck (which is typically at least 7/16" thick OSB or 3/8" thick plywood). These products can provide soffit-to-ridge ventilation, and if installed in accordance with the deck manufacturer's instructions to achieve sufficient ventilation, will not reduce the scope or length of CertainTeed's Limited Warranty coverage.

Limited Algae-Resistant Warranty

Blue-green algae, which is commonly but incorrectly called "fungus," can create unsightly streaking on shingles. CertainTeed warrants that the Algae-Resistant (AR) versions of the products in Table 1 will remain free from blue-green algae growth (but not mold or mildew growth) which adversely affects the overall appearance of said shingles for a period of ten (10) or fifteen (15) years, as noted in Table 1.

If during the Algae-Resistant Warranty Period specified in Table 1, the overall appearance of the Algae-Resistant shingles is adversely affected by blue-green algae, CertainTeed will pay the reasonable cost to replace or clean at its option, any affected shingles. In the event of replacement or cleaning, for the remainder of the Algae-Resistant Warranty Period, CertainTeed's maximum contribution towards subsequent replacement or cleaning will be calculated using the Algae-Resistant Warranty Period specified in Table 1, less a prorated

adjustment that reflects the number of months that have elapsed from the start of the Algae-Resistant Warranty Period to the date of reoccurrence.

WARNING: FOR LOW-VOLUME RAIN AND SALT FOG AREAS

In areas of low-volume rain (e.g. areas that receive insignificant rainfall during a 90-day period) and/or "salt fog" (e.g. parts of the Southern California coastline), copper released by algae-resistant (AR) granules or shingles can react with aluminum in gutters and cause severe corrosion of the gutters. In such regions, CertainTeed strongly recommends that vinyl or copper gutters, not aluminum gutters, be used with algae-resistant shingles. CertainTeed disclaims all liability and responsibility for any damages that may result from the use of its algae-resistant shingle products with copper granules where gutters containing aluminum are used.

Limited Wind Warranty

CertainTeed warrants its shingles will resist blow-off damage due to wind velocities, including gusts, up to the maximum wind velocity per the Wind Warranty MPH specified in Table 1 during the first fifteen (15) years of the warranty for Lifetime products and Patriot shingles for the first ten (10) years and during the first five (5) years for all other products listed in Table 1.

CertainTeed's obligations and liability for shingle blow-off damage during the wind warranty periods as specified above are limited as follows:

- If shingles blow off because the shingle's self-sealing asphalt strips did not activate, CertainTeed will have no liability or warranty obligation unless CertainTeed is afforded the opportunity to hand seal, at its expense, any non-sealing shingles.
- If shingles blow off even though the shingle's self-sealing asphalt strips did activate, CertainTeed will furnish replacement shingles without charge, but only for damaged or blown off shingles. CertainTeed will not be responsible for or reimburse labor costs, roof tear-off, metal work, flashing and disposal expenses, or any other costs pertaining to removal or replacement of damaged shingles. Any costs in excess of CertainTeed's material contribution are the property owner's responsibility (and may be covered by homeowner's insurance).
- CertainTeed shall have no liability for any shingles not fastened in accordance with CertainTeed installation instructions published at the time of original installation.
- CertainTeed shall have no liability for any damage to persons or property caused by blown off shingles.
- CertainTeed's maximum liability during the wind warranty period is the reasonable cost of hand sealing all of the shingles on the roof.

Flintlastic® SA (Self-Adhering) System

For low slope residential roofing projects less than 2000 square feet (20 squares), CertainTeed offers a limited roof membrane warranty as follows: A 10-year warranty duration on a single ply of Flintlastic SA Cap sheet over a primed plywood roof deck or a 12-year warranty duration for a two-ply system consisting of a Flintlastic SA Nail Base and a Flintlastic SA Cap sheet, provided the Flintlastic products were applied in accordance with CertainTeed's current installation instructions published at the time of installation.

CertainTeed warrants the roof membrane, subject to the following terms, conditions, limitations, and exclusions, for the duration specified above from the date of completion of the roof membrane installation. If during the duration of this Limited Warranty, a manufacturing defect in the roof membrane causes a leak, CertainTeed or its designated roofing contractor will, at CertainTeed's sole discretion, repair or replace the roof membrane materials only as necessary to restore it to a watertight condition.

Only manufacturing defects in the roof membrane that cause leaks are covered by this Limited Warranty. CertainTeed's MAXIMUM LIABILITY during the first year of this warranty is the original cost of the CertainTeed membrane materials only. After the first year, CertainTeed's maximum liability is the original cost of the CertainTeed materials used on the roof reduced by 8.3% for 12-year warranty and 10% for 10-year warranty during each subsequent year, less any costs previously incurred by CertainTeed for repair or replacements.

Roof components which are not part of the roof membrane and hence not covered by this Limited Warranty include, but are not limited to, the following: underlying roof deck, insulation, vapor retarders, fasteners, metal work, drains, pitch pans, expansion joints, skylights, vents, plastic accessories, any flashing, decorative or reflective coating, surfacing and/or any

aggregates. In no event, however, will CertainTeed be responsible for any costs related to the removal or abatement of any asbestos present in any existing roof system to which the CertainTeed roof membrane is applied.

What the Customer Must Do

If you believe your shingles have a manufacturing defect, you must promptly notify CertainTeed and provide proof of property ownership and the date of shingle purchase and application. Unless you provide such proof, CertainTeed will use the date of manufacture to calculate the start of the warranty period. In order to properly evaluate and process a warranty claim, CertainTeed may require the property owner to submit a shingle sample to CertainTeed for analysis and/or permit a CertainTeed representative to make repairs to, take photographs of, and/or take samples from the roof, if required. CertainTeed will evaluate each properly reported claim and will repair, replace, clean or reimburse the property owner for the shingles it determines are defective, in accordance with the terms of this Limited Warranty within a reasonable amount of time. For more details about submitting a warranty claim, visit www.ctroof.com or call (800) 345-1145.

Please send all notifications and correspondence to:

CertainTeed Corporation, 1508 Delph Road, Harleysville, PA 19438

Attn: CertainTeed Roofing Technical Services Department. Telephone number: 800-345-1145.

Warranty Registration (not required)

You may register your product warranty on CertainTeed's website:

www.certainteed.com/warrantyreg. Each registrant receives a registration confirmation number by return e-mail that can be printed and kept with this Limited Warranty and your proof of purchase. If you do not have internet access, you can register your shingles by sending: (1) your name, address, and telephone number; (2) the name and contact information of the contractor who installed your shingles and the original date of installation; and, (3) the type, color and number of squares of your shingles to: **CertainTeed Corporation, 1508 Delph Road, Harleysville, PA 19438, Attn: CertainTeed Roofing Technical Services Department.**

CertainTeed will register your information and mail you a confirmation number.

Failure to register this warranty does NOT void the warranty or any of its terms.

For Your Records

Product Purchased: _____ Date of Installation: _____

Roofing Contractor: _____ Contractor's Telephone No. _____

This warranty applies to shingles installed during the calendar year of 2015.

(The warranty in effect at the time the material is originally installed is the applicable warranty.)

Limited Warranty and Limitation of Remedies

THIS DOCUMENT CONSTITUTES THE EXCLUSIVE WARRANTIES AND REMEDIES PROVIDED BY CERTAINTEED. THE WARRANTIES AND REMEDIES CONTAINED IN THIS DOCUMENT ARE EXPRESSLY IN LIEU OF ANY AND ALL OTHER OBLIGATIONS, GUARANTEES AND WARRANTIES, WHETHER WRITTEN, ORAL OR IMPLIED BY STATUTE OR AT LAW. STATE OR PROVINCIAL LAW WILL DETERMINE THE PERIOD OF TIME FOLLOWING THE SALE THAT A PROPERTY OWNER MAY SEEK A REMEDY UNDER THE IMPLIED WARRANTY OF MERCHANTABILITY OR FITNESS FOR A PARTICULAR PURPOSE.

CERTAINTEED'S OBLIGATIONS, RESPONSIBILITIES, AND LIABILITY SHALL BE LIMITED TO REPAIRING OR REPLACING THE DEFECTIVE PRODUCT OR CLEANING ALGAE-RESISTANT SHINGLES IN THE CASE OF ALGAE GROWTH AS SET FORTH IN THIS LIMITED WARRANTY. IN NO EVENT SHALL CERTAINTEED BE LIABLE FOR ANY SPECIAL, INDIRECT, INCIDENTAL OR CONSEQUENTIAL DAMAGES OF ANY KIND, INCLUDING ANY DAMAGE TO THE PROPERTY, THE BUILDING OR ITS CONTENTS, OR FOR INJURY TO ANY PERSONS, THAT MAY OCCUR AS A RESULT OF THE USE OF CERTAINTEED'S PRODUCTS OR AS A RESULT OF THE BREACH OF THIS WARRANTY. IF YOUR STATE OR PROVINCE DOES NOT ALLOW EXCLUSIONS OR LIMITATIONS OF SPECIAL, INDIRECT, INCIDENTAL OR CONSEQUENTIAL DAMAGES, THE ABOVE LIMITATIONS MAY NOT APPLY TO YOU.

IN NO EVENT SHALL CERTAINTEED'S TOTAL LIABILITY ARISING OUT OF OR RELATED TO THE PRODUCT(S) OR THIS LIMITED WARRANTY EXCEED THE REASONABLE COST OF SHINGLES AND LABOR TO REPLACE OR REPAIR THE DEFECTIVE SHINGLES.

CertainTeed
2015 Limited Warranty
Symphony™



ASK ABOUT ALL OF OUR OTHER CERTAINTEED® PRODUCTS AND SYSTEMS:

ROOFING • SIDING • TRIM • DECKING • RAILING • FENCE
GYPSUM • CEILINGS • INSULATION

www.certainteed.com <http://blog.certainteed.com>

CertainTeed Corporation
P.O. Box 860
Valley Forge, PA 19482

Professional: 800-233-8990
Consumer: 800-782-8777

© CertainTeed Corporation, Printed in U.S.A.
Code No. 20-20-3067
1/2015



CertainTeed
SAINT-GOBAIN



Symphony™

*Where old-world elegance meets
new-world technology...in perfect harmony*

What the Customer Must Do

If you believe your shingles have a manufacturing defect, you must provide prompt written notification to CertainTeed with proof of the date of purchase and date of shingle application. CertainTeed will investigate each properly reported claim and will repair, replace or reimburse the homeowner for the shingles determined to be defective, in accordance with the terms of this Limited Warranty, within a reasonable amount of time if its inspection of the shingles confirms a manufacturing defect.

Please send all notifications and correspondence to:

CertainTeed Corporation, 1508 Delp Drive, Harleysville, PA 19438

Attn: CertainTeed Roofing Technical Services Department, Telephone number: 800-345-1145

Warranty Registration (not required)

You may register your product warranty on CertainTeed's website: www.certainteed.com/warrantyreg. Each registrant receives a registration confirmation number by return e-mail that can be printed and kept with this Limited Warranty and your proof of purchase. If you do not have internet access, you can register your shingles by sending: (1) your name, address, and telephone number; (2) the name and contact information of the contractor who installed your shingles and the original date of installation; and (3) the type, color and number of squares of your shingles to:

CertainTeed Corporation, CertainTeed Roofing, P.O. Box 860, Valley Forge, PA 19482

CertainTeed will register your information and mail you a confirmation number. Failure to register this warranty does NOT void the warranty or any of its terms.

Roofing Plants and Regional Sales Offices

CertainTeed roofing products are sold by the CertainTeed Corporation in eight sales regions. They are manufactured in ten residential roofing plants and two commercial roofing plants.

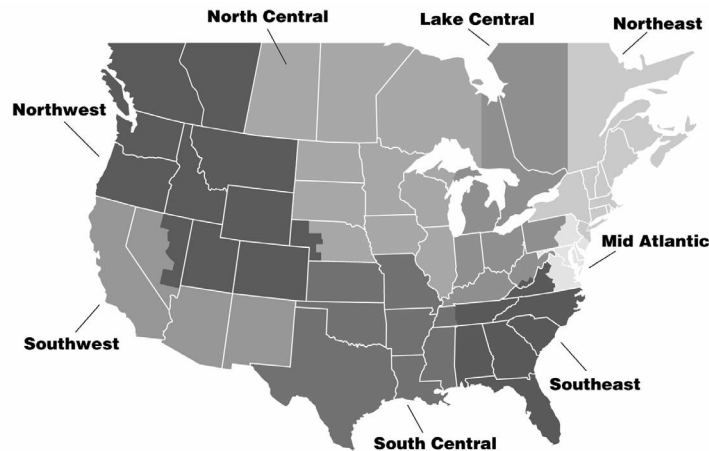

Through innovation and creative product design, CertainTeed has helped shape the building products industry for more than 100 years. Founded in 1904 as General Roofing Manufacturing Company, the firm made its slogan "*Quality made certain. Satisfaction guaranteed.*" which quickly inspired the name CertainTeed. Today, CertainTeed is North America's leading brand of exterior and interior building products, including roofing, siding, windows, fence, decking, railing, trim, foundations, pipe, insulation, walls, ceilings and access covers. Headquarter in Valley Forge, PA, CertainTeed and its affiliates have approximately 9,000 employees and 70 manufacturing facilities throughout the United States and Canada. More information is available at www.certainteed.com.

CONGRATULATIONS! ...and thank you for your recent purchase of one of the fine products produced by CertainTeed Roofing. Since 1904, CertainTeed has been producing quality roofing products that provide long-lasting beauty and protection for homes of every size, style and age. For the past 100 years, the basis for our name, "*Quality made certain, satisfaction guaranteed.*" has been our ongoing philosophy.

Your CertainTeed roofing warranty fully explains how CertainTeed supports its products with the strongest warranty protection available. It is important that you read the warranty section of this brochure.

Take the time to understand how CertainTeed protects your purchase by standing behind our products.

LIMITED, PRORATED, AND TRANSFERABLE WARRANTY

This warranty covers Symphony™ sold only in the United States of America, its territories and Canada.

What and Who is Covered and for How Long

CertainTeed warrants to the original property owner/consumer that, when subject to normal and proper use, Symphony shingles will be free from manufacturing defects that cause leaks for fifty (50) years from the date of original installation and that CertainTeed will pay to repair or replace, at its option, any shingles CertainTeed determines to be defective under the terms of this Limited Warranty.

In the event of repair or replacement pursuant to the terms of this Limited Warranty, the original warranty applicable at the time of original installation shall apply to the replacement shingles or the repaired shingles.

SureStart™ Protection

All of CertainTeed's shingle products are covered by SureStart protection. Under this warranty feature, CertainTeed, at no charge, will pay to repair or replace, at its option, any shingles CertainTeed determines to be defective and that cause leaks during the applicable SureStart period. For Symphony shingles, the SureStart period begins when the original shingle installation has been completed and terminates at the completion of its seventh (7th) year of service following original installation. CertainTeed's maximum liability under SureStart is equal to the reasonable material and labor cost to replace or repair the defective shingles that cause leaks, as determined by CertainTeed. Roof tear-off, metal work, flashing and disposal expenses, and other costs or expenses incurred during such repair or replacement are not covered or reimbursed by this Limited Warranty.

SureStart protection does not extend to any Symphony shingles applied to any non-ventilated or inadequately ventilated roof deck systems, except as stated below. CertainTeed's maximum contribution toward the cost of repairing or replacing defective shingles applied to a non-ventilated or inadequately ventilated roof deck system shall not exceed \$350/square, less 1/120th of that amount times the number of months from the date the shingles were originally installed to the date when CertainTeed determined the shingles to be defective. Labor costs, roof tear-off, metal work, flashing and disposal expenses, and other costs or expenses incurred during such repair or replacement are not covered or reimbursed by this Limited Warranty.

Beyond SureStart™ Protection

If CertainTeed determines the Symphony shingles to be defective and cause leaks after the SureStart period, CertainTeed's maximum contribution toward the cost of repairing or replacing such defective shingles shall not exceed \$350/square, less 1/600th of that amount times the number of months from the date the shingles were originally installed to the date when CertainTeed determined the shingles to be defective. Labor costs, roof tear-off, metal work, flashing and disposal expenses, and other costs or expenses incurred during such repair or replacement are not covered or reimbursed by this Limited Warranty.

Transferability

The Limited Warranty for Symphony shingles may only be transferred by the original property owner/consumer to a subsequent property owner one (1) time in the first two (2) years after original installation. The warranty transfer is only effective if the subsequent property owner provides written notice of the transfer to CertainTeed within sixty (60) days from the real estate transfer date. (A warranty transfer request must be sent to RPG Technical Services Department, 1508 Delp Drive, Harleysville, PA 19438.) After two (2) years, this Limited Warranty is not transferable.

Limitations

This Limited Warranty does not provide protection against and CertainTeed will have no liability for any failure, defect or damage caused by situations and events beyond normal exposure conditions, including but not limited to:

- Winds, including gusts, greater than 90 mph, lightning, hurricane (see “Limited Wind Warranty” section for hurricane wind exception), tornado, hailstorm, earthquake, fire, explosion, flood or falling objects.
- Distortion, cracking or other failure or movement of the base material over which the shingles are applied, of the roof deck, or of the walls or foundation of the building itself.
- Damage caused by structural changes, alterations or additions, or by the installation of equipment (such as aerials, signs or air-conditioning equipment) to the structure after the original shingles have been applied.
- Shading, stains or discoloration to the shingles arising from outside sources such as but not limited to the sun, algae, fungus, moss, lichens or other vegetation, mold or mildew growth, or paints, chemicals or other similar materials.
- Misuse, abuse, neglect, or improper transportation, handling or storage of the shingles.
- Installation of the shingles over non-approved roof decks as more fully explained in the CertainTeed Symphony installation instructions.
- Improper installation or installation not in accordance with CertainTeed’s written installation instructions applicable at the time of original installation.
- Damage to the shingles, the roof deck or the structure caused by ice backup or ice damming.
- Distortion or warping due to excessive or unusual heat sources, including without limitation, window reflections and heat buildup caused by inadequate roof ventilation.
- Vandalism or acts of war.
- Any other cause not a result of a manufacturing defect in the shingles.

Mold and mildew are functions of environmental conditions and are not manufacturing defects. As such, mold and mildew are not covered by this Limited Warranty or any implied warranty.

CertainTeed reserves the right to discontinue or modify any of its products, including the color of its shingles, and shall not be liable as a result of such discontinuance or modification, nor shall CertainTeed be liable in the event replacement material varies in color in comparison to the original product as a result of normal weathering. If CertainTeed replaces any material under this warranty, it may substitute products designated by CertainTeed to be of comparable quality or price range in the event the product initially installed has been discontinued or modified.

Inadequately Ventilated and Non-Ventilated Decks

Any shingles applied to inadequately ventilated or non-ventilated decks, other than the shingles and deck systems described in the section titled “Insulated Decks and Radiant Barriers,” are subject to a reduced limited warranty period of ten (10) years. Shingle damage or defects related to the absence of adequate roof system ventilation do not qualify for SureStart protection, and are limited to ten (10) years of Beyond SureStart coverage.

Insulated Decks and Radiant Barriers

CertainTeed’s Limited Warranty, including SureStart coverage, will remain in force when Symphony shingles are applied to roof deck assemblies (slopes \geq 3:12) where foam insulation is prefabricated into the roof deck system (often called “nailboard insulation”), where insulation is installed beneath an acceptable roof deck system, or where radiant barriers are installed, with or without ventilation directly below the deck. Acceptable roof deck surfaces must consist of at least 3/8” thick plywood or 7/16” thick OSB. If a different deck surface material will be utilized, please contact CertainTeed’s Technical Services Department for assistance. See the following important restrictions.

The design professional is responsible for ensuring 1) proper quality and application of the insulation and/or radiant barrier; 2) provision of adequate structural ventilation and/or vapor retarders as determined to be necessary, and 3) that all local codes are met (particularly taking into account local climate conditions). Special attention must be taken if cellular foam, fiber glass, cellulose insulations or other highly-permeable insulation will be used in an unventilated system, or if the insulation/rafter or insulation/joist planes may create an air leak that could lead to moisture transmission and condensation problems.

*All these important factors and decisions, while **not** the responsibility of CertainTeed Corporation, are critical to assure proper deck system performance.*

Ventilated Nail-Base Roof Insulation

Ventilated nail-base roof insulation products consist of rigid insulation (typically foam board) and another layer of material that provides air space above the insulation and below the nailable deck (which is typically at least 7/16” thick OSB or minimum 3/8” plywood). These products can provide soffit-to-ridge ventilation over cathedral-type ceilings, and if used and installed properly will not reduce the scope or length of CertainTeed’s Limited Warranty coverage period. It is important to follow the deck manufacturer’s instructions to achieve sufficient ventilation. CertainTeed offers FlintBoard™ CV – cross-ventilating insulation boards with 1”, 1-1/2”, or 2” air channels.

Limited Wind Warranty

CertainTeed warrants Symphony shingles to resist blow-off damage due to wind velocities, including gusts and hurricane winds, up to 90 mph during the first five (5) years following original installation.

If any blow-off damage occurs in the first five (5) years following original installation, CertainTeed will replace all damaged shingles without charge. CertainTeed will not be responsible for or reimburse labor costs or any other costs incurred during removal or replacement of damaged shingles. Such costs or damages are the property owner’s responsibility (and may be covered by homeowner’s insurance).

LIMITED WARRANTY AND LIMITATION OF REMEDIES

THE OBLIGATIONS CONTAINED IN THIS LIMITED WARRANTY CONSTITUTE THE EXCLUSIVE REMEDY AND ARE EXPRESSLY IN LIEU OF ANY AND ALL OTHER OBLIGATIONS, GUARANTEES AND WARRANTIES. APPLICABLE STATE LAW WILL DETERMINE THE PERIOD OF TIME FOLLOWING THE SALE THAT A PROPERTY OWNER/CONSUMER MAY SEEK A REMEDY UNDER THE IMPLIED WARRANTY OF MERCHANTABILITY OR FITNESS FOR A PARTICULAR PURPOSE. CERTAINTEED’S OBLIGATIONS, RESPONSIBILITIES, AND/OR LIABILITY SHALL BE LIMITED TO REPAIRING OR REPLACING THE DEFECTIVE PRODUCT OR PROVIDING A REFUND PER THE TERMS OF THIS LIMITED WARRANTY. IN NO EVENT SHALL CERTAINTEED BE LIABLE FOR ANY INCIDENTAL OR CONSEQUENTIAL DAMAGES, INCLUDING ANY DAMAGE TO THE BUILDING, ITS CONTENTS, OR ANY PERSONS OR PROPERTY, THAT OCCUR AS A RESULT OF A BREACH. IF YOUR STATE DOES NOT ALLOW EXCLUSIONS OR LIMITATIONS OF INCIDENTAL OR CONSEQUENTIAL DAMAGES, THE ABOVE LIMITATIONS MAY NOT APPLY TO YOU.

This warranty applies to Symphony shingles installed during the calendar year of 2015.

CertainTeed

Limited Warranty

Asphalt Shingle Products

2016



CertainTeed
SAINT-GOBAIN

Congratulations... and thank you for your recent purchase of one of the fine products from CertainTeed Roofing. Since 1904, CertainTeed has been producing quality roofing products that provide long-lasting beauty and protection for homes of every size, style and age. For over 100 years, the basis for our name, "Quality made certain, satisfaction guaranteed," has been our ongoing philosophy.

Your CertainTeed roofing warranty fully explains how CertainTeed supports its products with the strongest warranty protection available. It is important that you read the warranty section of this brochure. The warranty lists the specific CertainTeed asphalt shingle products that are covered and the period of time for which they are covered. Take the time to understand how CertainTeed protects your purchase by standing behind our products.

Limited, Prorated and Transferable Warranty

This warranty covers asphalt shingle products listed in Table 1, sold only in the United States of America, its territories and Canada.

What and Who Is Covered and for How Long

CertainTeed warrants to the original property owner/consumer that, when subject to normal and proper use, its shingles will be free from manufacturing defects for the length of time specified in Table 1 and that CertainTeed will pay to repair, replace or clean, at its option, any shingles CertainTeed determines are defective under the terms of this Limited Warranty. In the event of repair, replacement or cleaning pursuant to the terms of this Limited Warranty, the warranty applicable to the original shingles shall apply to the repaired, replaced or cleaned shingles and will extend for the balance of the original warranty period.

The Lifetime warranty period offered for certain shingles in Table 1 is only available to individual homeowners. The warranty period for shingles installed on premises not used by individual homeowners as their residence is limited as specified in Table 1. All other structures and property owners (e.g. corporations, governmental agencies, partnerships, trusts, religious organizations, schools, condominiums, homeowner associations or cooperative housing arrangements, apartment buildings, and any other type of building or premises not owned by individual homeowners) are limited to either a 50-year or 40-year warranty period described in Table 1.

Lifetime means as long as the original individual home owner owns the property where the shingles are installed.

SureStart™ Protection

Because CertainTeed roofing products are manufactured to the highest quality standards, we confidently include the additional assurance of SureStart™ protection. SureStart provides the strongest non prorated protection you can get in the vital early years of your new roof.

All of CertainTeed's shingle products are covered by SureStart protection. Under this warranty feature, CertainTeed, at no charge, will pay to repair or replace, at its option, any shingles CertainTeed determines are defective during the SureStart period. Note: Wind warranty and algae warranty are covered separately as described on pages 4 & 5. The SureStart period begins on the date of application and terminates following the period specified in Table 1. CertainTeed's maximum liability under SureStart is equal to the reasonable cost of comparable replacement shingles and labor as determined by CertainTeed to replace or repair the defective shingles. Roof tear-off, metal work, flashing and disposal expenses, and other costs or expenses incurred during such repair or replacement are not covered or reimbursed by this Limited Warranty, except for certain products with Lifetime warranty periods specified in Table 1, for which CertainTeed's maximum liability also includes the cost of roof tear-off and disposal.

In instances in which CertainTeed, under the terms of this warranty, has agreed to pay the reasonable cost of labor required to repair or replace defective shingles, CertainTeed will provide reimbursement only upon receipt of a copy of the contractor's invoice or other written evidence of the completion of such work which CertainTeed, in its sole discretion, deems acceptable.

SureStart protection does not extend to any shingles applied to non-ventilated or inadequately ventilated roof deck systems as determined by CertainTeed, except as stated on page 4.

CertainTeed's maximum contribution toward the cost of repairing or replacing defective shingles applied to a non-ventilated or inadequately ventilated roof deck system is calculated using the reasonable cost of comparable replacement shingles as determined by CertainTeed less 1/120th

of that amount multiplied by the number of months from the start of the warranty period to the date when CertainTeed determines the shingles are defective. Labor costs, roof tear-off, metal work, flashing and disposal expenses, and other costs or expenses incurred during such repair or replacement are not covered or reimbursed by this Limited Warranty.

Beyond SureStart Protection

If CertainTeed determines its shingles are defective after the SureStart period, CertainTeed's maximum contribution toward the cost of repairing or replacing defective shingles will be calculated using the reasonable cost of comparable replacement shingles as determined by CertainTeed less the Reduction Figure Per Month, specified in Table 1, for the number of months from the start of the warranty period to the date when CertainTeed determines the shingles are defective. Labor costs, roof tear-off, metal work, flashing and disposal expenses, and other costs or expenses incurred during such repair or replacement are not covered or reimbursed by this Limited Warranty.

TABLE 1

	Warranty Period	SureStart Period	Wind Warranty Miles Per Hour	Algae Resistant Warranty Period ¹	Reduction Figure Per Month
Lifetime Products^A					
Grand Manor® Presidential Shake® TL Presidential Solaris® Landmark® TL Presidential Shake® (& IR) ² Carriage House® Landmark® Premium Landmark Solaris® (& IR) ² Landmark® PRO NorthGate® Highland State® (& IR) ² Independence®	Lifetime ^A	10 Years	110 ^{††}	15	1/600*
Lifetime Products^B					
Landmark® IR ² Landmark® Hatteras®	Lifetime ^B	10 Years	110 ^{††}	10	1/600*
20 -, 25 - and 30 - Year Products					
Patriot®	30 Years	8 Years	110	10	1/360
XT®30 (& IR) ²	30 Years	5 Years	70	10	1/360
XT®25 ³	25 Years	5 Years	60	10	1/300
CT®20	20 Years	3 Years	60	10	1/240
Any shingles applied to any inadequately ventilated roof deck	10 years [†]	N/A	N/A	N/A	1/120

A. The Lifetime Warranty period is only available to individual homeowners. The warranty period for these shingles installed on premises not used by individual homeowners as their residence is limited to 50 years and the SureStart period is 10 years following the installation of the shingles. Roof tear-off, metal work, flashing and disposal expense, incurred during repair or replacement are covered or reimbursed by this Limited Warranty. Limited Warranty transferees during the SureStart period are limited to a 50-year warranty period (see section titled "Transfers During the SureStart Period" for details).

B. The Lifetime Warranty period is only available to individual homeowners. The warranty period for these shingles installed on premises not used by individual homeowners as their residence is limited to 40 years and the SureStart period is 5 years following the installation of the shingles. Limited Warranty transferees during the SureStart period are limited to a 40-year warranty period (see section titled "Transfers During the SureStart Period" for details).

* For Lifetime products, at the completion of the 40th year the reduction figure will remain at 480/600, or 20% of the total maximum liability.

† For details of warranty coverage for shingles installed on inadequately ventilated roof decks on both residential and commercial buildings, see provisions under "Inadequately Ventilated and Non-Ventilated Decks."

†† Wind warranty upgrade – These products are warranted to resist blow-off due to wind velocities, including gusts, up to a maximum of 130 miles per hour during the first fifteen (15) years, provided all of the following conditions are met:

1. The CertainTeed shingles are not applied over existing roof shingles (roof-overs are not permitted).
2. The CertainTeed specified corresponding hip and ridge accessory products are installed as cap shingles (Shadow Ridge™, Cedar Crest™, Shangle Ridge™, Mountain Ridge™ Landmark Solaris® (& IR) and Hatteras®).
3. The CertainTeed specified corresponding starter shingles are installed along the roof eaves and rakes (Swiftstart™, High-Performance Starter and Presidential Starter).

(Note: In Florida, CertainTeed will waive the requirement of applying starter shingles along the roof rake if all of the following conditions are met: The applicable building code requires that asphalt roof shingles be embedded in an 8-inch-wide bed of asphalt roofing cement applied along the roof rake edges. And, the shingles are installed and embedded in an 8-inch-wide bed of asphalt roofing cement along the roof rake edges in accordance with the code.)

¹Algae Resistant Warranty period applies only to the Algae Resistant (AR) version of the pertinent shingle.

²CertainTeed's Impact Resistant (IR) versions of Landmark®, Presidential Shake®, Highland Slate®, Landmark Solaris®, and XT®30 shingles comply with UL 2218 Impact Resistance of Prepared Roof Covering Materials test criteria at time of manufacture.

³The wind warranty for XT25 shingles installed in Alaska is 90 mph.

Transferability

This Limited Warranty is transferable, but only by the original property owner/consumer to the first subsequent property owner. After the Limited Warranty has been transferred once, it is no longer transferable.

Transfers During the SureStart Period

If this Limited Warranty is transferred during the product's SureStart period, the warranty for the new owner is the same as it would have been for the original owner, except for certain products with Lifetime warranty periods where the duration of the transferred warranty will be 50 years or 40 years as specified in Table 1, measured from the beginning of the SureStart period (i.e. the date of installation), and the remaining period of SureStart protection will be available to the subsequent property owner.

Transfers After the SureStart Period

If this Limited Warranty is transferred by the original property owner/consumer after the SureStart period, the warranty following the transfer will be limited to two (2) years from the date of real estate title transfer. The warranty obligation will be calculated as explained in the section titled "Beyond SureStart Protection."

Limitations

This Limited Warranty does not provide protection against, and CertainTeed will have no liability for, any failure, defect or damage caused by situations and events beyond normal exposure conditions, including but not limited to:

- Winds, including gusts, greater than the Wind Warranty MPH in Table 1.
- Damage caused by lightning, hailstorm, earthquake, fire, explosion, flood or falling objects.
- Damage caused by tornado, or hurricanes (other than as warranted under Wind Warranty MPH in Table 1).
- Distortion, cracking or other failure or movement of: the base material over which the shingles are applied, the roof deck, or the walls or foundation of the building itself.
- Damage caused by structural changes, alterations or additions, or by the installation of equipment (such as, but not limited to, aerials, signs or air-conditioning equipment) to the building after the original shingles have been applied.
- Shading, stains or discoloration to the shingles arising from outside sources such as, but not limited to, algae (unless blue-green algae as described in the section titled "Limited Algae Warranty"), fungus, moss, lichens or other vegetation, mold or mildew growth, or paints, chemicals or other similar materials.
- Misuse, abuse, neglect, or improper transportation, handling or storage of the shingles.
- Installation of the shingles over non-approved roof decks as more fully explained in CertainTeed's installation instructions published at the time of original installation.
- Damage caused by improper installation or installation not in accordance with CertainTeed's installation instructions published at the time of original installation.
- Damage to the shingles, the roof deck or the structure caused by ice backup or ice damming.
- Damage caused by impact, including such things as tools, equipment or foot traffic.

- Vandalism or acts of war.
- Any other cause not a result of a manufacturing defect in the shingles.
- Animals, animal feces or insects.

Mold and mildew are functions of environmental conditions and are not manufacturing defects. As such, mold and mildew are not covered by this Limited Warranty or any implied warranty.

CertainTeed reserves the right to discontinue or modify any of its products, including the color of its shingles, and shall not be liable as a result of such discontinuance or modification, nor shall CertainTeed be liable in the event replacement material varies in color in comparison to the original product as a result of normal weathering. If CertainTeed replaces any material under this warranty, it may substitute products designated by CertainTeed to be of comparable quality or price range in the event the product initially installed has been discontinued or modified.

Inadequately Ventilated and Non-Ventilated Decks

Any shingles applied to inadequately ventilated or non-ventilated decks, other than the shingles and deck systems described in the section titled "Insulated Decks and Radiant Barriers," are subject to a reduced limited warranty period of ten (10) years and do not qualify for SureStart Protection. **SureStart Protection and the Warranty Period applicable to the shingle are available if** CertainTeed determines that the shingle damage was caused exclusively by a manufacturing defect that is unrelated to the inadequate roof system ventilation.

Insulated Decks and Radiant Barriers

CertainTeed's Limited Warranty, including SureStart Protection, will remain in force when its fiber glass shingles are applied to roof deck assemblies where foam insulation is prefabricated into the roof deck system (often called "nailboard insulation"), where insulation is installed beneath an acceptable roof deck system, or where radiant barriers are installed, with or without ventilation, directly below the deck. Acceptable roof deck surfaces must consist of at least 3/8" thick plywood or 7/16" thick Oriented Strand Board (OSB) and slopes must be 2:12 or greater. If a different deck surface material will be utilized, please contact CertainTeed's Technical Services Department for assistance. (See the following important restrictions.)

The design professional is responsible for ensuring: 1) the proper quality and application of the insulation and/or radiant barrier, 2) the provision of adequate structural ventilation and/or vapor retarders as determined to be necessary, and 3) that all local codes are met (particularly taking into account local climate conditions). Special attention must be taken if cellular foam, fiber glass, cellulose insulation or other highly permeable insulation will be used in an unventilated system, or if the insulation/rafter or insulation/joist planes may create an air leak that could lead to moisture transmission and condensation problems. All these important factors and decisions, while not the responsibility of CertainTeed, are critical to assure proper deck system performance.

Ventilated Nail-Base Roof Insulation

Ventilated Nail-Base Roof Insulation products (e.g. FlintBoard® CV) are made of rigid insulation (typically foam board) and another layer of material that provides air space above the insulation and below the nailable deck (which is typically at least 7/16" thick OSB or 3/8" thick plywood). These products can provide soffit-to-ridge ventilation, and if installed in accordance with the deck manufacturer's instructions to achieve sufficient ventilation, will not reduce the scope or length of CertainTeed's Limited Warranty coverage.

Limited Algae-Resistant Warranty

Blue-green algae, which is commonly but incorrectly called "fungus," can create unsightly streaking on shingles. CertainTeed warrants that the Algae-Resistant (AR) versions of the products in Table 1 will remain free from blue-green algae growth (but not mold or mildew growth) which adversely affects the overall appearance of said shingles for a period of ten (10) or fifteen (15) years, as noted in Table 1.

If during the Algae-Resistant Warranty Period specified in Table 1, the overall appearance of the Algae-Resistant shingles is adversely affected by blue-green algae, CertainTeed will pay the reasonable cost to replace or clean at its option, any affected shingles. In the event of replacement or cleaning, for the remainder of the Algae-Resistant Warranty Period, CertainTeed's maximum contribution towards subsequent replacement or cleaning will be calculated using the Algae-Resistant Warranty Period specified in Table 1, less a prorated

adjustment that reflects the number of months that have elapsed from the start of the Algae-Resistant Warranty Period to the date of reoccurrence.

WARNING: FOR LOW-VOLUME RAIN AND SALT FOG AREAS

In areas of low-volume rain (e.g. areas that receive insignificant rainfall during a 90-day period) and/or "salt fog" (e.g. parts of the Southern California coastline), copper released by algae-resistant (AR) granules or shingles can react with aluminum in gutters and cause severe corrosion of the gutters. In such regions, CertainTeed strongly recommends that vinyl or copper gutters, not aluminum gutters, be used with algae-resistant shingles. CertainTeed disclaims all liability and responsibility for any damages that may result from the use of its algae-resistant shingle products with copper granules where gutters containing aluminum are used.

Limited Wind Warranty

CertainTeed warrants its shingles will resist blow-off damage due to wind velocities, including gusts, up to the maximum wind velocity per the Wind Warranty MPH specified in Table 1 during the first fifteen (15) years of the warranty for Lifetime products and Patriot shingles for the first ten (10) years and during the first five (5) years for all other products listed in Table 1.

CertainTeed's obligations and liability for shingle blow-off damage during the wind warranty periods as specified above are limited as follows:

- If shingles blow off because the shingle's self-sealing asphalt strips did not activate, CertainTeed will have no liability or warranty obligation unless CertainTeed is afforded the opportunity to hand seal, at its expense, any non-sealing shingles.
- If shingles blow off even though the shingle's self-sealing asphalt strips did activate, CertainTeed will furnish replacement shingles without charge, but only for damaged or blown off shingles. CertainTeed will not be responsible for or reimburse labor costs, roof tear-off, metal work, flashing and disposal expenses, or any other costs pertaining to removal or replacement of damaged shingles. Any costs in excess of CertainTeed's material contribution are the property owner's responsibility (and may be covered by homeowner's insurance).
- CertainTeed shall have no liability for any shingles not fastened in accordance with CertainTeed installation instructions published at the time of original installation.
- CertainTeed shall have no liability for any damage to persons or property caused by blown off shingles.
- CertainTeed's maximum liability during the wind warranty period is the reasonable cost of hand sealing all of the shingles on the roof.

Flintlastic® SA (Self-Adhering) System

For low slope residential roofing projects less than 2000 square feet (20 squares), CertainTeed offers a limited roof membrane warranty as follows: A 10-year warranty duration on a single ply of Flintlastic SA Cap sheet over a primed plywood roof deck or a 12-year warranty duration for a two-ply system consisting of a Flintlastic SA Nail Base and a Flintlastic SA Cap sheet, provided the Flintlastic products were applied in accordance with CertainTeed's current installation instructions published at the time of installation.

CertainTeed warrants the roof membrane, subject to the following terms, conditions, limitations, and exclusions, for the duration specified above from the date of completion of the roof membrane installation. If during the duration of this Limited Warranty, a manufacturing defect in the roof membrane causes a leak, CertainTeed or its designated roofing contractor will, at CertainTeed's sole discretion, repair or replace the roof membrane materials only as necessary to restore it to a watertight condition.

Only manufacturing defects in the roof membrane that cause leaks are covered by this Limited Warranty. CertainTeed's MAXIMUM LIABILITY during the first year of this warranty is the original cost of the CertainTeed membrane materials only. After the first year, CertainTeed's maximum liability is the original cost of the CertainTeed materials used on the roof reduced by 8.3% for 12-year warranty and 10% for 10-year warranty during each subsequent year, less any costs previously incurred by CertainTeed for repair or replacements.

Roof components which are not part of the roof membrane and hence not covered by this Limited Warranty include, but are not limited to, the following: underlying roof deck, insulation, vapor retarders, fasteners, metal work, drains, pitch pans, expansion joints, skylights, vents, plastic accessories, any flashing, decorative or reflective coating, surfacing and/or any

aggregates. In no event, however, will CertainTeed be responsible for any costs related to the removal or abatement of any asbestos present in any existing roof system to which the CertainTeed roof membrane is applied.

What the Customer Must Do

If you believe your shingles have a manufacturing defect, you must promptly notify CertainTeed and provide proof of property ownership and the date of shingle purchase and application. Unless you provide such proof, CertainTeed will use the date of manufacture to calculate the start of the warranty period. In order to properly evaluate and process a warranty claim, CertainTeed may require the property owner to submit a shingle sample to CertainTeed for analysis and/or permit a CertainTeed representative to make repairs to, take photographs of, and/or take samples from the roof, if required. CertainTeed will evaluate each properly reported claim and will repair, replace, clean or reimburse the property owner for the shingles it determines are defective, in accordance with the terms of this Limited Warranty within a reasonable amount of time. For more details about submitting a warranty claim, visit www.ctroof.com or call (800) 345-1145.

Please send all notifications and correspondence to:

CertainTeed Corporation, 20 Moores Road, Malvern, PA 19355

Attn: CertainTeed Roofing Technical Services Department. Telephone number: 800-345-1145.

Warranty Registration (not required)

You may register your product warranty on CertainTeed's website:

www.certainteed.com/warrantyreg. Each registrant receives a registration confirmation number by return e-mail that can be printed and kept with this Limited Warranty and your proof of purchase. If you do not have internet access, you can register your shingles by sending: (1) your name, address, and telephone number; (2) the name and contact information of the contractor who installed your shingles and the original date of installation; and, (3) the type, color and number of squares of your shingles to: **CertainTeed Corporation, 20 Moores Road, Malvern, PA 19355, Attn: CertainTeed Roofing Technical Services Department.**

CertainTeed will register your information and mail you a confirmation number.

Failure to register this warranty does NOT void the warranty or any of its terms.

For Your Records

Product Purchased: _____ Date of Installation: _____

Roofing Contractor: _____ Contractor's Telephone No. _____

This warranty applies to shingles installed during the calendar year of 2016.

(The warranty in effect at the time the material is originally installed is the applicable warranty.)

Limited Warranty and Limitation of Remedies

THIS DOCUMENT CONSTITUTES THE EXCLUSIVE WARRANTIES AND REMEDIES PROVIDED BY CERTAINTEED. THE WARRANTIES AND REMEDIES CONTAINED IN THIS DOCUMENT ARE EXPRESSLY IN LIEU OF ANY AND ALL OTHER OBLIGATIONS, GUARANTEES AND WARRANTIES, WHETHER WRITTEN, ORAL OR IMPLIED BY STATUTE OR AT LAW. STATE OR PROVINCIAL LAW WILL DETERMINE THE PERIOD OF TIME FOLLOWING THE SALE THAT A PROPERTY OWNER MAY SEEK A REMEDY UNDER THE IMPLIED WARRANTY OF MERCHANTABILITY OR FITNESS FOR A PARTICULAR PURPOSE.

CERTAINTEED'S OBLIGATIONS, RESPONSIBILITIES, AND LIABILITY SHALL BE LIMITED TO REPAIRING OR REPLACING THE DEFECTIVE PRODUCT OR CLEANING ALGAE-RESISTANT SHINGLES IN THE CASE OF ALGAE GROWTH AS SET FORTH IN THIS LIMITED WARRANTY. IN NO EVENT SHALL CERTAINTEED BE LIABLE FOR ANY SPECIAL, INDIRECT, INCIDENTAL OR CONSEQUENTIAL DAMAGES OF ANY KIND, INCLUDING ANY DAMAGE TO THE PROPERTY, THE BUILDING OR ITS CONTENTS, OR FOR INJURY TO ANY PERSONS, THAT MAY OCCUR AS A RESULT OF THE USE OF CERTAINTEED'S PRODUCTS OR AS A RESULT OF THE BREACH OF THIS WARRANTY. IF YOUR STATE OR PROVINCE DOES NOT ALLOW EXCLUSIONS OR LIMITATIONS OF SPECIAL, INDIRECT, INCIDENTAL OR CONSEQUENTIAL DAMAGES, THE ABOVE LIMITATIONS MAY NOT APPLY TO YOU.

IN NO EVENT SHALL CERTAINTEED'S TOTAL LIABILITY ARISING OUT OF OR RELATED TO THE PRODUCT(S) OR THIS LIMITED WARRANTY EXCEED THE REASONABLE COST OF SHINGLES AND LABOR TO REPLACE OR REPAIR THE DEFECTIVE SHINGLES.

This Limited Warranty may not be modified, altered or expanded by anyone, including product distributors, dealers, sellers and/or CertainTeed field representatives. This Limited Warranty gives you specific legal rights, and you may also have other rights which vary from State to State, or Province to Province.

Roofing Plants and Regional Sales Office

CertainTeed roofing products are sold by CertainTeed Roofing in nine sales regions. They are manufactured in ten residential roofing plants and one commercial roofing plant. Since the early 1900s, CertainTeed Corporation has been an innovator in the building materials industry and today is a leading manufacturer of building materials including residential and commercial roofing, vinyl siding, composite decking and railing, fiber glass insulation and vinyl fence products. The company is headquartered in Valley Forge, Pennsylvania, and employs more than 7,000 employees at approximately 50 manufacturing facilities throughout North America. Continuing the 100-year commitment of "Quality made certain, Satisfaction guaranteed™," CertainTeed remains one of the most trusted names in the industry. More information is available at www.certainteed.com.

This document is also available in Spanish and French.

Call 1-800-782-8777 or go to www.certainteed.com.

Se puede obtener este documento en español. Favor de llamar 1-800-782-8777.

Ce document est disponible en anglais et en espagnol. Composez le 1-800-782-8777.

ASK ABOUT OUR OTHER CERTAINTEED® PRODUCTS AND SYSTEMS

ROOFING • SIDING • TRIM • DECKING • RAILING • FENCE
GYPSUM • CEILINGS • INSULATION

www.certainteed.com <http://blog.certainteed.com>

CertainTeed Corporation
20 Moores Road / Malvern, PA 19355
Professional: 800-233-8990 / Consumer: 800-782-8777

©2016 CertainTeed Corporation, Printed in U.S.A.

20-20-3596



CertainTeed

2016 Limited Warranty

Symphony™



ASK ABOUT ALL OF OUR OTHER CERTAINTEED® PRODUCTS AND SYSTEMS:

ROOFING • SIDING • TRIM • DECKING • RAILING • FENCE
GYPSUM • CEILINGS • INSULATION

www.certainteed.com <http://blog.certainteed.com>

CertainTeed Corporation
20 Moores Road
Malvern, PA 19355

Professional: 800-233-8990
Consumer: 800-782-8777

© CertainTeed Corporation, Printed in U.S.A.
Code No. 20-20-3067
1/2016



CertainTeed
SAINT-GOBAIN



Symphony™

*Where old-world elegance meets
new-world technology...in perfect harmony*

What the Customer Must Do

If you believe your shingles have a manufacturing defect, you must provide prompt written notification to CertainTeed with proof of the date of purchase and date of shingle application. CertainTeed will investigate each properly reported claim and will repair, replace or reimburse the homeowner for the shingles determined to be defective, in accordance with the terms of this Limited Warranty, within a reasonable amount of time if its inspection of the shingles confirms a manufacturing defect.

Please send all notifications and correspondence to:

CertainTeed Corporation, 20 Moores Road, Malvern, PA 19355

Attn: CertainTeed Roofing Technical Services Department, Telephone number: 800-345-1145

Warranty Registration (not required)

You may register your product warranty on CertainTeed's website: www.certainteed.com/warrantyreg. Each registrant receives a registration confirmation number by return e-mail that can be printed and kept with this Limited Warranty and your proof of purchase. If you do not have internet access, you can register your shingles by sending: (1) your name, address, and telephone number; (2) the name and contact information of the contractor who installed your shingles and the original date of installation; and (3) the type, color and number of squares of your shingles to:

CertainTeed Corporation, CertainTeed Roofing, 20 Moores Road, Malvern, PA 19355

CertainTeed will register your information and mail you a confirmation number. Failure to register this warranty does NOT void the warranty or any of its terms.

Roofing Plants and Regional Sales Offices

CertainTeed roofing products are sold by the CertainTeed Corporation in eight sales regions. They are manufactured in ten residential roofing plants and two commercial roofing plants.

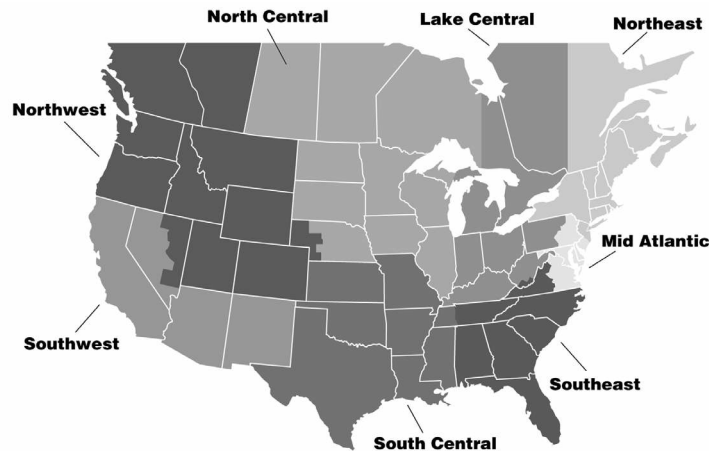

Through innovation and creative product design, CertainTeed has helped shape the building products industry for more than 100 years. Founded in 1904 as General Roofing Manufacturing Company, the firm made its slogan "*Quality made certain. Satisfaction guaranteed.*" which quickly inspired the name CertainTeed. Today, CertainTeed is North America's leading brand of exterior and interior building products, including roofing, siding, windows, fence, decking, railing, trim, foundations, pipe, insulation, walls, ceilings and access covers. Headquarter in Valley Forge, PA, CertainTeed and its affiliates have approximately 9,000 employees and 70 manufacturing facilities throughout the United States and Canada. More information is available at www.certainteed.com.

CONGRATULATIONS! ...and thank you for your recent purchase of one of the fine products produced by CertainTeed Roofing. Since 1904, CertainTeed has been producing quality roofing products that provide long-lasting beauty and protection for homes of every size, style and age. For the past 100 years, the basis for our name, "*Quality made certain, satisfaction guaranteed.*" has been our ongoing philosophy.

Your CertainTeed roofing warranty fully explains how CertainTeed supports its products with the strongest warranty protection available. It is important that you read the warranty section of this brochure.

Take the time to understand how CertainTeed protects your purchase by standing behind our products.

LIMITED, PRORATED, AND TRANSFERABLE WARRANTY

This warranty covers Symphony™ sold only in the United States of America, its territories and Canada.

What and Who is Covered and for How Long

CertainTeed warrants to the original property owner/consumer that, when subject to normal and proper use, Symphony shingles will be free from manufacturing defects that cause leaks for fifty (50) years from the date of original installation and that CertainTeed will pay to repair or replace, at its option, any shingles CertainTeed determines to be defective under the terms of this Limited Warranty.

In the event of repair or replacement pursuant to the terms of this Limited Warranty, the original warranty applicable at the time of original installation shall apply to the replacement shingles or the repaired shingles.

SureStart™ Protection

All of CertainTeed's shingle products are covered by SureStart protection. Under this warranty feature, CertainTeed, at no charge, will pay to repair or replace, at its option, any shingles CertainTeed determines to be defective and that cause leaks during the applicable SureStart period. For Symphony shingles, the SureStart period begins when the original shingle installation has been completed and terminates at the completion of its seventh (7th) year of service following original installation. CertainTeed's maximum liability under SureStart is equal to the reasonable material and labor cost to replace or repair the defective shingles that cause leaks, as determined by CertainTeed. Roof tear-off, metal work, flashing and disposal expenses, and other costs or expenses incurred during such repair or replacement are not covered or reimbursed by this Limited Warranty.

SureStart protection does not extend to any Symphony shingles applied to any non-ventilated or inadequately ventilated roof deck systems, except as stated below. CertainTeed's maximum contribution toward the cost of repairing or replacing defective shingles applied to a non-ventilated or inadequately ventilated roof deck system shall not exceed \$350/square, less 1/120th of that amount times the number of months from the date the shingles were originally installed to the date when CertainTeed determined the shingles to be defective. Labor costs, roof tear-off, metal work, flashing and disposal expenses, and other costs or expenses incurred during such repair or replacement are not covered or reimbursed by this Limited Warranty.

Beyond SureStart™ Protection

If CertainTeed determines the Symphony shingles to be defective and cause leaks after the SureStart period, CertainTeed's maximum contribution toward the cost of repairing or replacing such defective shingles shall not exceed \$350/square, less 1/600th of that amount times the number of months from the date the shingles were originally installed to the date when CertainTeed determined the shingles to be defective. Labor costs, roof tear-off, metal work, flashing and disposal expenses, and other costs or expenses incurred during such repair or replacement are not covered or reimbursed by this Limited Warranty.

Transferability

The Limited Warranty for Symphony shingles may only be transferred by the original property owner/consumer to a subsequent property owner one (1) time in the first two (2) years after original installation. The warranty transfer is only effective if the subsequent property owner provides written notice of the transfer to CertainTeed within sixty (60) days from the real estate transfer date. (A warranty transfer request must be sent to RPG Technical Services Department, 20 Moores Road, Malvern, PA 19355.) After two (2) years, this Limited Warranty is not transferable.

Limitations

This Limited Warranty does not provide protection against and CertainTeed will have no liability for any failure, defect or damage caused by situations and events beyond normal exposure conditions, including but not limited to:

- Winds, including gusts, greater than 90 mph, lightning, hurricane (see "Limited Wind Warranty" section for hurricane wind exception), tornado, hailstorm, earthquake, fire, explosion, flood or falling objects.
- Distortion, cracking or other failure or movement of the base material over which the shingles are applied, of the roof deck, or of the walls or foundation of the building itself.
- Damage caused by structural changes, alterations or additions, or by the installation of equipment (such as aerials, signs or air-conditioning equipment) to the structure after the original shingles have been applied.
- Shading, stains or discoloration to the shingles arising from outside sources such as but not limited to the sun, algae, fungus, moss, lichens or other vegetation, mold or mildew growth, or paints, chemicals or other similar materials.
- Misuse, abuse, neglect, or improper transportation, handling or storage of the shingles.
- Installation of the shingles over non-approved roof decks as more fully explained in the CertainTeed Symphony installation instructions.
- Improper installation or installation not in accordance with CertainTeed's written installation instructions applicable at the time of original installation.
- Damage to the shingles, the roof deck or the structure caused by ice backup or ice damming.
- Distortion or warping due to excessive or unusual heat sources, including without limitation, window reflections and heat buildup caused by inadequate roof ventilation.
- Vandalism or acts of war.
- Any other cause not a result of a manufacturing defect in the shingles.

Mold and mildew are functions of environmental conditions and are not manufacturing defects. As such, mold and mildew are not covered by this Limited Warranty or any implied warranty.

CertainTeed reserves the right to discontinue or modify any of its products, including the color of its shingles, and shall not be liable as a result of such discontinuance or modification, nor shall CertainTeed be liable in the event replacement material varies in color in comparison to the original product as a result of normal weathering. If CertainTeed replaces any material under this warranty, it may substitute products designated by CertainTeed to be of comparable quality or price range in the event the product initially installed has been discontinued or modified.

Inadequately Ventilated and Non-Ventilated Decks

Any shingles applied to inadequately ventilated or non-ventilated decks, other than the shingles and deck systems described in the section titled "Insulated Decks and Radiant Barriers," are subject to a reduced limited warranty period of ten (10) years. Shingle damage or defects related to the absence of adequate roof system ventilation do not qualify for SureStart protection, and are limited to ten (10) years of Beyond SureStart coverage.

Insulated Decks and Radiant Barriers

CertainTeed's Limited Warranty, including SureStart coverage, will remain in force when Symphony shingles are applied to roof deck assemblies (slopes $\geq 3:12$) where foam insulation is prefabricated into the roof deck system (often called "nailboard insulation"), where insulation is installed beneath an acceptable roof deck system, or where radiant barriers are installed, with or without ventilation directly below the deck. Acceptable roof deck surfaces must consist of at least 3/8" thick plywood or 7/16" thick OSB. If a different deck surface material will be utilized, please contact CertainTeed's Technical Services Department for assistance. See the following important restrictions.

The design professional is responsible for ensuring 1) proper quality and application of the insulation and/or radiant barrier; 2) provision of adequate structural ventilation and/or vapor retarders as determined to be necessary, and 3) that all local codes are met (particularly taking into account local climate conditions). Special attention must be taken if cellular foam, fiber glass, cellulose insulations or other highly-permeable insulation will be used in an unventilated system, or if the insulation/rafter or insulation/joist planes may create an air leak that could lead to moisture transmission and condensation problems.

*All these important factors and decisions, while **not** the responsibility of CertainTeed Corporation, are critical to assure proper deck system performance.*

Ventilated Nail-Base Roof Insulation

Ventilated nail-base roof insulation products consist of rigid insulation (typically foam board) and another layer of material that provides air space above the insulation and below the nailable deck (which is typically at least 7/16" thick OSB or minimum 3/8" plywood). These products can provide soffit-to-ridge ventilation over cathedral-type ceilings, and if used and installed properly will not reduce the scope or length of CertainTeed's Limited Warranty coverage period. It is important to follow the deck manufacturer's instructions to achieve sufficient ventilation. CertainTeed offers FlintBoard™ CV – cross-ventilating insulation boards with 1", 1-1/2", or 2" air channels.

Limited Wind Warranty

CertainTeed warrants Symphony shingles to resist blow-off damage due to wind velocities, including gusts and hurricane winds, up to 90 mph during the first five (5) years following original installation.

If any blow-off damage occurs in the first five (5) years following original installation, CertainTeed will replace all damaged shingles without charge. CertainTeed will not be responsible for or reimburse labor costs or any other costs incurred during removal or replacement of damaged shingles. Such costs or damages are the property owner's responsibility (and may be covered by homeowner's insurance).

LIMITED WARRANTY AND LIMITATION OF REMEDIES

THE OBLIGATIONS CONTAINED IN THIS LIMITED WARRANTY CONSTITUTE THE EXCLUSIVE REMEDY AND ARE EXPRESSLY IN LIEU OF ANY AND ALL OTHER OBLIGATIONS, GUARANTEES AND WARRANTIES. APPLICABLE STATE LAW WILL DETERMINE THE PERIOD OF TIME FOLLOWING THE SALE THAT A PROPERTY OWNER/CONSUMER MAY SEEK A REMEDY UNDER THE IMPLIED WARRANTY OF MERCHANTABILITY OR FITNESS FOR A PARTICULAR PURPOSE. CERTAINTEED'S OBLIGATIONS, RESPONSIBILITIES, AND/OR LIABILITY SHALL BE LIMITED TO REPAIRING OR REPLACING THE DEFECTIVE PRODUCT OR PROVIDING A REFUND PER THE TERMS OF THIS LIMITED WARRANTY. IN NO EVENT SHALL CERTAINTEED BE LIABLE FOR ANY INCIDENTAL OR CONSEQUENTIAL DAMAGES, INCLUDING ANY DAMAGE TO THE BUILDING, ITS CONTENTS, OR ANY PERSONS OR PROPERTY, THAT OCCUR AS A RESULT OF A BREACH. IF YOUR STATE DOES NOT ALLOW EXCLUSIONS OR LIMITATIONS OF INCIDENTAL OR CONSEQUENTIAL DAMAGES, THE ABOVE LIMITATIONS MAY NOT APPLY TO YOU.

This warranty applies to Symphony shingles installed during the calendar year of 2016.

CertainTeed

Limited Warranty

Asphalt Shingle Products

2017



CertainTeed
SAINT-GOBAIN

Congratulations... and thank you for your recent purchase of one of the fine products from CertainTeed Roofing. Since 1904, CertainTeed has been producing quality roofing products that provide long-lasting beauty and protection for homes of every size, style and age. For over 100 years, the basis for our name, "Quality made certain, satisfaction guaranteed," has been our ongoing philosophy.

Your CertainTeed roofing warranty fully explains how CertainTeed supports its products with the strongest warranty protection available. It is important that you read the warranty section of this brochure. The warranty lists the specific CertainTeed asphalt shingle products that are covered and the period of time for which they are covered. Take the time to understand how CertainTeed protects your purchase by standing behind our products.

Limited, Prorated and Transferable Warranty

This warranty covers asphalt shingle products listed in Table 1, sold only in the United States of America, its territories and Canada.

What and Who Are Covered and for How Long

From the date of installation, CertainTeed warrants to the original property owner/consumer that, when subject to normal and proper use, its shingles will be free from manufacturing defects for the warranty period specified in Table 1. CertainTeed will pay to repair, replace or clean, at its option, any shingles CertainTeed determines are defective under the terms of this Limited Warranty. In the event of repair, replacement or cleaning pursuant to the terms of this Limited Warranty, the warranty applicable to the original shingles shall apply to the repaired, replaced or cleaned shingles and will extend for the balance of the original warranty period.

Lifetime means for as long as the original individual home owner owns the property where the shingles are installed.

The Lifetime warranty period offered for certain shingles in Table 1 is only available to individual homeowners. The warranty period for shingles installed on premises not used by individual homeowners as their residence is limited as specified in Table 1. All property owners, who are not individual homeowners, and all structures not used by individual homeowners as their residence (e.g. corporations, governmental agencies, partnerships, trusts, religious organizations, schools, condominiums, homeowner associations or cooperative housing arrangements, apartment buildings, and any other type of building or premises not owned by individual homeowners) called "Other Ownership" are limited to either a 50-year or 40-year warranty period described in Table 1. In addition, for Other Ownership after the SureStart™ Protection period ends, this Limited Warranty covers only manufacturing defects that caused water penetration.

SureStart™ Protection

Because CertainTeed roofing products are manufactured to the highest quality standards, we confidently include the additional assurance of SureStart™ protection. SureStart provides the strongest non prorated protection you can get in the vital early years of your new roof.

All of CertainTeed's shingle products are covered by SureStart protection. Under this warranty feature, CertainTeed, at no charge, will pay to repair or replace, at its option, any shingles CertainTeed determines are defective during the SureStart period. Note: Wind warranty and algae warranty are covered separately as described on page 5. The SureStart period begins on the date of application and terminates following the warranty period specified in Table 1. CertainTeed's maximum liability under SureStart is equal to the reasonable cost of comparable replacement shingles and labor as determined by CertainTeed to replace or repair the defective shingles. Roof tear-off, metal work, flashing and disposal expenses, and other costs or expenses incurred during such repair or replacement are not covered or reimbursed by this Limited Warranty, except for certain products with Lifetime warranty periods specified in Table 1, for which CertainTeed's maximum liability also includes the cost of roof tear-off, metal work, flashing and disposal.

In instances in which CertainTeed, under the terms of this warranty, has agreed to pay the reasonable cost of labor required to repair or replace defective shingles, CertainTeed will determine labor costs by Bluebook® or RS Means® data. CertainTeed will provide reimbursement for labor only upon receipt of a copy of the contractor's invoice or other written evidence of the completion of such work which CertainTeed, in its sole discretion, deems acceptable.

Costs associated with removal or replacement of overburden (items installed over the shingles, including but not limited to, solar panels, satellite dishes and gardens) are the sole responsibility of the property owner.

SureStart protection does not extend to any shingles applied to non-ventilated or inadequately ventilated roof deck systems as determined by CertainTeed, except as stated on page 4. CertainTeed's maximum contribution toward the cost of repairing or replacing defective shingles applied to a non-ventilated or inadequately ventilated roof deck system is calculated using the reasonable cost of comparable replacement shingles as determined by CertainTeed less 1/120th of that amount multiplied by the number of months from the start of the warranty period to the date when CertainTeed determines the shingles are defective. Labor costs, roof tear-off, metal work, flashing and disposal expenses, and other costs or expenses incurred during such repair or replacement are not covered or reimbursed by this Limited Warranty.

Beyond SureStart™ Protection

After the SureStart Protection period, if CertainTeed determines its shingles have a manufacturing defect, or for Other Ownership, if CertainTeed determines its shingles have a manufacturing defect that caused water penetration, CertainTeed's maximum contribution toward the cost of repairing or replacing defective shingles will be calculated using the reasonable cost of comparable replacement shingles as determined by CertainTeed less the Reduction Figure Per Month, specified in Table 1, for the number of months from the start of the warranty period to the date when CertainTeed determines the shingles are defective. Labor costs, roof tear-off, metal work, flashing and disposal expenses, and other costs or expenses incurred during such repair or replacement are not covered or reimbursed by this Limited Warranty.

TABLE 1

<u>Lifetime Products^A</u>	<u>Warranty Period</u>	<u>SureStart Period</u>	<u>Wind Warranty Miles Per Hour</u>	<u>Algae Resistant Warranty Period¹</u>	<u>Reduction Figure Per Month</u>
Grand Manor® Arcadia Shake™ Presidential Shake® TL Presidential Solaris® Landmark® TL Presidential Shake® (& IR) ² Carriage House® Belmont™ (& IR) ² Landmark® Premium Landmark Solaris® (& IR) ² Landmark® PRO NorthGate® Highland Slate® (& IR) ² Independence®	Lifetime ^a	10 Years	110 ^{tt}	15	1/600*
<u>Lifetime Products^B</u>	<u>Warranty Period</u>	<u>SureStart Period</u>	<u>Wind Warranty Miles Per Hour</u>	<u>Algae Resistant Warranty Period¹</u>	<u>Reduction Figure Per Month</u>
Landmark® IR ² Landmark® Hatteras®	Lifetime ^a	10 Years	110 ^{tt}	10	1/600*
<u>20 -, 25 - and 30 - Year Products</u>	<u>Warranty Period</u>	<u>SureStart Period</u>	<u>Wind Warranty Miles Per Hour</u>	<u>Algae Resistant Warranty Period¹</u>	<u>Reduction Figure Per Month</u>
Patriot	30 Years	8 Years	110	10	1/360
XT™ 30 (& IR) ²	30 Years	5 Years	70	10	1/360
XT™ 25 ³	25 Years	5 Years	60	10	1/300
CT™ 20	20 Years	3 Years	60	10	1/240
Any shingles applied to any inadequately ventilated roof deck (see footnotes to Table 1 on the next page)	10 years ^t	N/A	N/A	N/A	1/120

FOOTNOTES TO TABLE 1.

A. The Lifetime Warranty period is only available to individual homeowners. The warranty period for these shingles installed on premises not used by individual homeowners as their residence is limited to 50 years and the SureStart period is 10 years following the installation of the shingles. Roof tear-off, metal work, flashing and disposal expense, incurred during repair or replacement are covered or reimbursed by this Limited Warranty. Limited Warranty transferees during the SureStart™ period are limited to a 50-year warranty period (see section titled "Transfers During the SureStart Period" for details).

B. The Lifetime Warranty period is only available to individual homeowners. The warranty period for these shingles installed on premises not used by individual homeowners as their residence is limited to 40 years and the SureStart period is 5 years following the installation of the shingles. Limited Warranty transferees during the SureStart period are limited to a 40-year warranty period (see section titled "Transfers During the SureStart Period" for details).

* For Lifetime products, at the completion of the 40th year the reduction figure will remain at 480/600, or 20% of the total maximum liability.

† For details of warranty coverage for shingles installed on inadequately ventilated roof decks on both residential and commercial buildings, see provisions under "Inadequately Ventilated and Non-Ventilated Decks."

†† Wind warranty upgrade – These products are warranted to resist blow-off due to wind velocities, including gusts, up to a maximum of 130 miles per hour during the first fifteen (15) years, provided all of the following conditions are met:

1. The CertainTeed shingles are not applied over existing roof shingles (roof-overs are not permitted).
2. The CertainTeed specified corresponding hip and ridge accessory products are installed as cap shingles (Shadow Ridge®, Cedar Crest®, Shangle Ridge®, Mountain Ridge® Landmark Solaris® (& IR) and Hatteras®).
3. The CertainTeed specified corresponding starter shingles are installed along the roof eaves and rakes (Swiftstart®, High-Performance Starter and Presidential® Starter).

(Note: In Florida, CertainTeed will waive the requirement of applying starter shingles along the roof rake if all of the following conditions are met: The applicable building code requires that asphalt roof shingles be embedded in an 8-inch-wide bed of asphalt roofing cement applied along the roof rake edges. And, the shingles are installed and embedded in an 8-inch-wide bed of asphalt roofing cement along the roof rake edges in accordance with the code.)

¹Algae Resistant Warranty period applies only to the Algae Resistant (AR) version of the pertinent shingle.

²CertainTeed's Impact Resistant (IR) versions of Landmark®, Presidential Shake®, Belmont, Highland Slate®, Landmark Solaris®, and XT™30 shingles comply with UL 2218 Impact Resistance of Prepared Roof Covering Materials test criteria at time of manufacture.

³The wind warranty for XT™25 shingles installed in Alaska is 90 mph.

Transferability

This Limited Warranty is transferable, but only by the original property owner/consumer to the first subsequent property owner. After the Limited Warranty has been transferred once, it is no longer transferable. A bank foreclosure or a change of ownership on a deed is deemed a transfer under this Limited Warranty.

Transfers During the SureStart™ Period

If this Limited Warranty is transferred during the product's SureStart period, the warranty for the new owner is the same as it would have been for the original owner, except for certain products with Lifetime warranty periods where the duration of the transferred warranty will be 50 years or 40 years as specified in Table 1, measured from the beginning of the SureStart period (i.e. the date of installation), and the remaining period of SureStart protection will be available to the subsequent property owner.

Transfers After the SureStart Period

If this Limited Warranty is transferred by the original property owner/consumer after the SureStart period, the warranty following the transfer will be limited to two (2) years from the date of the transfer. The warranty obligation will be calculated as explained in the section titled "Beyond SureStart Protection."

Limitations

This Limited Warranty does not provide protection against, and CertainTeed will have no liability for, any failure, defect or damage as a result of, including but not limited to:

- Winds, including gusts, greater than the Wind Warranty MPH in Table 1
- Damage caused by lightning, hailstorm, earthquake, fire, explosion, flood or falling objects.
- Damage caused by tornado, or hurricanes (other than as warranted under Wind Warranty MPH in Table 1).
- Distortion, cracking or other failure or movement of: the base material over which the shingles are applied, the roof deck, or the walls or foundation of the building itself.
- Damage caused by structural changes, alterations or additions, or by the installation of equipment (such as, but not limited to, aerials, signs or air-conditioning equipment) to the building after the original shingles have been applied.

- Shading, stains or discoloration to the shingles arising from outside sources such as, but not limited to, algae (unless blue-green algae as described in the section titled "Limited Algae Warranty"), fungus, moss, lichens or other vegetation, mold or mildew growth, or paints, chemicals or other similar materials.
- Misuse, abuse, neglect, or improper transportation, handling or storage of the shingles.
- Installation of the shingles over non-approved roof decks as more fully explained in CertainTeed's installation instructions published at the time of original installation.
- Damage caused by improper installation or installation not in accordance with CertainTeed's installation instructions published at the time of original installation.
- Damage to the shingles, the roof deck or the structure caused by ice backup or ice damming.
- Damage caused by impact, including such things as tools, equipment or foot traffic.
- Vandalism or acts of war.
- Animals, animal feces or insects.
- Any other cause not a result of a manufacturing defect in the shingles.

Mold and mildew are functions of environmental conditions and are not manufacturing defects. As such, mold and mildew are not covered by this Limited Warranty or any implied warranty.

CertainTeed reserves the right to discontinue or modify any of its products, including the color of its shingles, and shall not be liable as a result of such discontinuance or modification, nor shall CertainTeed be liable in the event replacement material varies in color in comparison to the original product as a result of normal weathering. If CertainTeed replaces any material under this warranty, it may substitute products designated by CertainTeed to be of comparable quality or price range in the event the product initially installed has been discontinued or modified.

Inadequately Ventilated and Non-Ventilated Decks

Any shingles applied to inadequately ventilated or non-ventilated decks, other than the shingles and deck systems described in the section titled "Insulated Decks and Radiant Barriers," are subject to a reduced limited warranty period of ten (10) years and do not qualify for SureStart Protection. **SureStart™ Protection and the Warranty Period applicable to the shingle are available if CertainTeed determines that the shingle damage was caused exclusively by a manufacturing defect that is unrelated to the inadequate roof system ventilation.**

Insulated Decks and Radiant Barriers

CertainTeed's Limited Warranty, including SureStart Protection, will remain in force when its fiber glass shingles are applied to roof deck assemblies where foam insulation is prefabricated into the roof deck system (often called "nailboard insulation"), where insulation is installed beneath an acceptable roof deck system, or where radiant barriers are installed, with or without ventilation, directly below the deck. Acceptable roof deck surfaces must consist of at least 3/8" thick plywood or 7/16" thick Oriented Strand Board (OSB) and slopes must be 2:12 or greater. If a different deck surface material will be utilized, please contact CertainTeed's Technical Services Department for assistance. (See the following important restrictions.)

The design professional is responsible for ensuring: 1) the proper quality and application of the insulation and/or radiant barrier, 2) the provision of adequate structural ventilation and/or vapor retarders as determined to be necessary, and 3) that all local codes are met (particularly taking into account local climate conditions). Special attention must be taken if cellular foam, fiber glass, cellulose insulation or other highly permeable insulation will be used in an unventilated system, or if the insulation/rafter or insulation/joist planes may create an air leak that could lead to moisture transmission and condensation problems. All these important factors and decisions, while not the responsibility of CertainTeed, are critical to assure proper deck system performance.

Ventilated Nail-Base Roof Insulation

Ventilated Nail-Base Roof Insulation products (e.g. FlintBoard® CV) are made of rigid insulation (typically foam board) and another layer of material that provides air space above the insulation and below the nailable deck (which is typically at least 7/16" thick OSB or 3/8" thick plywood). These products can provide soffit-to-ridge ventilation, and if installed in accordance with the deck manufacturer's instructions to achieve sufficient ventilation, will not reduce the scope or length of CertainTeed's Limited Warranty coverage.

Limited Algae-Resistant Warranty

Blue-green algae, which is commonly but incorrectly called “fungus,” can create unsightly streaking on shingles. CertainTeed warrants that the Algae-Resistant (AR) versions of the products in Table 1 will remain free from blue-green algae growth (but not mold or mildew growth) which adversely affects the overall appearance of said shingles for a period of ten (10) or fifteen (15) years, as noted in Table 1.

If during the Algae-Resistant Warranty Period specified in Table 1, the overall appearance of the Algae-Resistant shingles is adversely affected by blue-green algae, CertainTeed will pay the reasonable cost to replace or clean at its option, any affected shingles. In the event of replacement or cleaning, for the remainder of the Algae-Resistant Warranty Period, CertainTeed’s maximum contribution towards subsequent replacement or cleaning will be calculated using the Algae-Resistant Warranty Period specified in Table 1, less a prorated adjustment that reflects the number of months that have elapsed from the start of the Algae-Resistant Warranty Period to the date of reoccurrence.

WARNING: FOR LOW-VOLUME RAIN AND SALT FOG AREAS

In areas of low-volume rain (e.g. areas that receive insignificant rainfall during a 90-day period) and/or “salt fog” (e.g. parts of the Southern California coastline), copper released by algae-resistant (AR) granules or shingles can react with aluminum in gutters and cause severe corrosion of the gutters. In such regions, CertainTeed strongly recommends that vinyl or copper gutters, not aluminum gutters, be used with algae-resistant shingles. CertainTeed disclaims all liability and responsibility for any damages that may result from the use of its algae-resistant shingle products with copper granules where gutters containing aluminum are used.

Limited Wind Warranty

CertainTeed warrants its shingles will resist blow-off damage due to wind velocities, including gusts, up to the maximum wind velocity per the Wind Warranty MPH specified in Table 1 during the first fifteen (15) years of the warranty for Lifetime products and Patriot shingles for the first ten (10) years and during the first five (5) years for all other products listed in Table 1.

CertainTeed’s obligations and liability for shingle blow-off damage during the wind warranty periods as specified above are limited as follows:

- If shingles blow off because the shingle’s self-sealing asphalt strips did not activate, CertainTeed will have no liability or warranty obligation unless CertainTeed is afforded the opportunity to hand seal, at its expense, any non-sealing shingles.
- If shingles blow off even though the shingle’s self-sealing asphalt strips did activate, CertainTeed will furnish replacement shingles without charge, but only for damaged or blown off shingles. CertainTeed will not be responsible for or reimburse labor costs, roof tear-off, metal work, flashing and disposal expenses, or any other costs pertaining to removal or replacement of damaged shingles. Any costs in excess of CertainTeed’s material contribution are the property owner’s responsibility (and may be covered by homeowner’s insurance).
- CertainTeed shall have no liability for any shingles not fastened in accordance with CertainTeed installation instructions published at the time of original installation.
- CertainTeed shall have no liability for any damage to persons or property caused by blown off shingles.
- CertainTeed’s maximum liability during the wind warranty period is the reasonable cost of hand sealing all of the shingles on the roof.

Flintlastic® SA (Self-Adhering) System

For low slope residential roofing projects less than 2000 square feet (20 squares), CertainTeed offers a limited roof membrane warranty as follows: A 10-year warranty duration on a single ply of Flintlastic SA Cap sheet over a primed plywood roof deck or a 12-year warranty duration for a two-ply system consisting of a Flintlastic SA Nail Base and a Flintlastic SA Cap sheet, provided the Flintlastic products were applied in accordance with CertainTeed’s current installation instructions published at the time of installation.

CertainTeed warrants the roof membrane, subject to the following terms, conditions, limitations, and exclusions, for the duration specified above from the date of completion of the roof membrane installation. If during the duration of this Limited Warranty, a manufacturing defect in the roof membrane causes a leak, CertainTeed or its designated roofing contractor will,

at CertainTeed's sole discretion, repair or replace the roof membrane materials only as necessary to restore it to a watertight condition.

Only manufacturing defects in the roof membrane that cause leaks are covered by this Limited Warranty. CertainTeed's MAXIMUM LIABILITY during the first year of this warranty is the original cost of the CertainTeed membrane materials only. After the first year, CertainTeed's maximum liability is the original cost of the CertainTeed materials used on the roof reduced by 8.3% for 12-year warranty and 10% for 10-year warranty during each subsequent year, less any costs previously incurred by CertainTeed for repair or replacements.

Roof components which are not part of the roof membrane and hence not covered by this Limited Warranty include, but are not limited to, the following: underlying roof deck, insulation, vapor retarders, fasteners, metal work, drains, pitch pans, expansion joints, skylights, vents, plastic accessories, any flashing, decorative or reflective coating, surfacing and/or any aggregates. In no event, however, will CertainTeed be responsible for any costs related to the removal or abatement of any asbestos present in any existing roof system to which the CertainTeed roof membrane is applied.

What the Customer Must Do

If you believe your shingles have a manufacturing defect, you must promptly notify CertainTeed and provide proof of property ownership and the date of shingle purchase and application. Unless you provide such proof, CertainTeed will use the date of manufacture to calculate the start of the warranty period. In order to properly evaluate and process a warranty claim, CertainTeed may require the property owner to submit a shingle sample to CertainTeed for analysis and/or permit a CertainTeed representative to make repairs to, take photographs of, and/or take samples from the roof, if required. CertainTeed will evaluate each properly reported claim and will repair, replace, clean or reimburse the property owner for the shingles it determines are defective, in accordance with the terms of this Limited Warranty within a reasonable amount of time. For more details about submitting a warranty claim, visit www.ctroof.com or call (800) 345-1145.

Please send all notifications and correspondence to:

CertainTeed Corporation, 1508 Delp Drive, Harleysville, PA 19438.

Attn: CertainTeed Roofing Technical Services Department. Telephone number: 800-345-1145.

Warranty Registration (not required)

You may register your product warranty on CertainTeed's website:

www.certainteed.com/warrantyreg. Each registrant receives a registration confirmation number by return e-mail that can be printed and kept with this Limited Warranty and your proof of purchase. If you do not have internet access, you can register your shingles by sending: (1) your name, address, and telephone number; (2) the name and contact information of the contractor who installed your shingles and the original date of installation; and, (3) the type, color and number of squares of your shingles to: **CertainTeed Corporation, 20 Moores Road, Malvern, PA 19355, Attn: CertainTeed Roofing Technical Services Department.**

CertainTeed will register your information and mail you a confirmation number. Failure to register this warranty does NOT void the warranty or any of its terms.

For Your Records

Product Purchased: _____ Date of Installation: _____

Roofing Contractor: _____ Contractor's Telephone No. _____

This warranty applies to shingles installed during the calendar year of 2017.

(The warranty in effect at the time the material is originally installed is the applicable warranty.)

Limited Warranty and Limitation of Remedies

THIS DOCUMENT CONSTITUTES THE EXCLUSIVE WARRANTIES AND REMEDIES PROVIDED BY CERTAINTEED. THE WARRANTIES AND REMEDIES CONTAINED IN THIS DOCUMENT ARE EXPRESSLY IN LIEU OF ANY AND ALL OTHER OBLIGATIONS, GUARANTEES, WARRANTIES AND REPRESENTATIONS, WHETHER WRITTEN, ORAL OR IMPLIED BY STATUTE, AT LAW OR IN EQUITY, INCLUDING WITHOUT LIMITATION, THE IMPLIED WARRANTIES OF MERCHANTABILITY AND FITNESS FOR A PARTICULAR PURPOSE. SOME STATES OR PROVINCES MAY NOT ALLOW THE EXCLUSION OF IMPLIED WARRANTIES OR MAY DETERMINE THE PERIOD OF TIME FOLLOWING THE SALE THAT A PURCHASER MAY SEEK A REMEDY UNDER IMPLIED WARRANTIES, SO THE ABOVE EXCLUSION MAY NOT APPLY TO YOU.

CERTAINTEED'S OBLIGATIONS, RESPONSIBILITIES, AND LIABILITY SHALL BE LIMITED TO REPAIRING OR REPLACING THE DEFECTIVE PRODUCT OR CLEANING ALGAE-RESISTANT SHINGLES IN THE CASE OF ALGAE GROWTH AS SET FORTH IN THIS LIMITED WARRANTY. IN NO EVENT SHALL CERTAINTEED BE LIABLE FOR ANY SPECIAL, INDIRECT, INCIDENTAL OR CONSEQUENTIAL DAMAGES OF ANY KIND, INCLUDING ANY DAMAGE TO THE PROPERTY, THE BUILDING OR ITS CONTENTS, OR FOR INJURY TO ANY PERSONS, THAT MAY OCCUR AS A RESULT OF THE USE OF CERTAINTEED'S PRODUCTS OR AS A RESULT OF THE BREACH OF THIS WARRANTY. IF YOUR STATE OR PROVINCE DOES NOT ALLOW EXCLUSIONS OR LIMITATIONS OF SPECIAL, INDIRECT, INCIDENTAL OR CONSEQUENTIAL DAMAGES, THE ABOVE LIMITATIONS MAY NOT APPLY TO YOU.

IN NO EVENT SHALL CERTAINTEED'S TOTAL LIABILITY ARISING OUT OF OR RELATED TO THE PRODUCT(S) OR THIS LIMITED WARRANTY EXCEED THE REASONABLE COST OF SHINGLES AND LABOR TO REPLACE OR REPAIR THE DEFECTIVE SHINGLES.

This Limited Warranty may not be modified, altered or expanded by anyone, including product distributors, dealers, sellers and/or CertainTeed field representatives.

This Limited Warranty gives you specific legal rights, and you may also have other rights which vary from State to State, or Province to Province.

Roofing Plants and Regional Sales Office

CertainTeed roofing products are sold by CertainTeed Roofing in nine sales regions. They are manufactured in ten residential roofing plants and one commercial roofing plant. Since the early 1900s, CertainTeed Corporation has been an innovator in the building materials industry and today is a leading manufacturer of building materials including residential and commercial roofing, vinyl siding, composite decking and railing, fiber glass insulation and vinyl fence products. The company is headquartered in Valley Forge, Pennsylvania, and employs more than 7,000 employees at approximately 50 manufacturing facilities throughout North America. Continuing the 100-year commitment of "Quality made certain, Satisfaction guaranteed™," CertainTeed remains one of the most trusted names in the industry. More information is available at www.certainteed.com.

This document is also available in Spanish and French.

Call 1-800-782-8777 or go to www.certainteed.com.

Se puede obtener este documento en español. Favor de llamar 1-800-782-8777.

Ce document est disponible en anglais et en espagnol. Composez le 1-800-782-8777.



CertainTeed Corporation

20 MOORES ROAD MALVERN, PA 19355

ASK ABOUT ALL OF OUR OTHER CERTAINTEED® PRODUCTS AND SYSTEMS:

ROOFING • SIDING • TRIM • DECKING • RAILING • FENCE
GYPSUM • CEILINGS • INSULATION

Professional: 800-233-8990 Consumer: 800-782-8777 certainteed.com

CertainTeed

2017 Limited Warranty

Symphony™



ASK ABOUT ALL OF OUR OTHER CERTAINTEED® PRODUCTS AND SYSTEMS:

ROOFING • SIDING • TRIM • DECKING • RAILING • FENCE
GYPSUM • CEILINGS • INSULATION

www.certainteed.com <http://blog.certainteed.com>

CertainTeed Corporation
20 Moores Road
Malvern, PA 19355

Professional: 800-233-8990
Consumer: 800-782-8777

© CertainTeed Corporation, Printed in U.S.A.
Code No. 20-20-3694

1/2017



CertainTeed
SAINT-GOBAIN



Symphony™

*Where old-world elegance meets
new-world technology...in perfect harmony*

What the Customer Must Do

If you believe your shingles have a manufacturing defect, you must provide prompt written notification to CertainTeed with proof of the date of purchase and date of shingle application. CertainTeed will investigate each properly reported claim and will repair, replace or reimburse the homeowner for the shingles determined to be defective, in accordance with the terms of this Limited Warranty, within a reasonable amount of time if its inspection of the shingles confirms a manufacturing defect.

Please send all notifications and correspondence to:

CertainTeed Corporation, 20 Moores Road, Malvern, PA 19355

Attn: CertainTeed Roofing Technical Services Department, Telephone number: 800-345-1145

Warranty Registration (not required)

You may register your product warranty on CertainTeed's website: www.certainteed.com/warrantyreg. Each registrant receives a registration confirmation number by return e-mail that can be printed and kept with this Limited Warranty and your proof of purchase. If you do not have internet access, you can register your shingles by sending: (1) your name, address, and telephone number; (2) the name and contact information of the contractor who installed your shingles and the original date of installation; and (3) the type, color and number of squares of your shingles to:

CertainTeed Corporation, CertainTeed Roofing, 20 Moores Road, Malvern, PA 19355

CertainTeed will register your information and mail you a confirmation number. Failure to register this warranty does NOT void the warranty or any of its terms.

Roofing Plants and Regional Sales Offices

CertainTeed roofing products are sold by the CertainTeed Corporation in eight sales regions. They are manufactured in ten residential roofing plants and two commercial roofing plants.

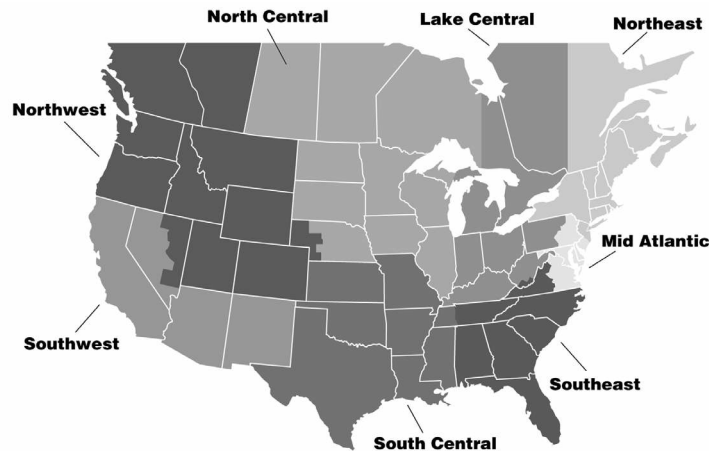

Through innovation and creative product design, CertainTeed has helped shape the building products industry for more than 100 years. Founded in 1904 as General Roofing Manufacturing Company, the firm made its slogan "*Quality made certain. Satisfaction guaranteed.*" which quickly inspired the name CertainTeed. Today, CertainTeed is North America's leading brand of exterior and interior building products, including roofing, siding, windows, fence, decking, railing, trim, foundations, pipe, insulation, walls, ceilings and access covers. Headquarter in Valley Forge, PA, CertainTeed and its affiliates have approximately 9,000 employees and 70 manufacturing facilities throughout the United States and Canada. More information is available at www.certainteed.com.

CONGRATULATIONS! ...and thank you for your recent purchase of one of the fine products produced by CertainTeed Roofing. Since 1904, CertainTeed has been producing quality roofing products that provide long-lasting beauty and protection for homes of every size, style and age. For the past 100 years, the basis for our name, "*Quality made certain, satisfaction guaranteed.*" has been our ongoing philosophy.

Your CertainTeed roofing warranty fully explains how CertainTeed supports its products with the strongest warranty protection available. It is important that you read the warranty section of this brochure. Take the time to understand how CertainTeed protects your purchase by standing behind our products.

LIMITED, PRORATED, AND TRANSFERABLE WARRANTY

This warranty covers Symphony™ sold only in the United States of America, its territories and Canada.

What and Who is Covered and for How Long

CertainTeed warrants to the original property owner/consumer that, when subject to normal and proper use, Symphony shingles will be free from manufacturing defects that cause leaks for fifty (50) years from the date of original installation and that CertainTeed will pay to repair or replace, at its option, any shingles CertainTeed determines to be defective under the terms of this Limited Warranty.

In the event of repair or replacement pursuant to the terms of this Limited Warranty, the original warranty applicable at the time of original installation shall apply to the replacement shingles or the repaired shingles.

SureStart™ Protection

All of CertainTeed's shingle products are covered by SureStart protection. Under this warranty feature, CertainTeed, at no charge, will pay to repair or replace, at its option, any shingles CertainTeed determines to be defective and that cause leaks during the applicable SureStart period. For Symphony shingles, the SureStart period begins when the original shingle installation has been completed and terminates at the completion of its seventh (7th) year of service following original installation. CertainTeed's maximum liability under SureStart is equal to the reasonable material and labor cost to replace or repair the defective shingles that cause leaks, as determined by CertainTeed. Roof tear-off, metal work, flashing and disposal expenses, and other costs or expenses incurred during such repair or replacement are not covered or reimbursed by this Limited Warranty.

SureStart protection does not extend to any Symphony shingles applied to any non-ventilated or inadequately ventilated roof deck systems, except as stated below. CertainTeed's maximum contribution toward the cost of repairing or replacing defective shingles applied to a non-ventilated or inadequately ventilated roof deck system shall not exceed \$350/square, less 1/120th of that amount times the number of months from the date the shingles were originally installed to the date when CertainTeed determined the shingles to be defective. Labor costs, roof tear-off, metal work, flashing and disposal expenses, and other costs or expenses incurred during such repair or replacement are not covered or reimbursed by this Limited Warranty.

Beyond SureStart™ Protection

If CertainTeed determines the Symphony shingles to be defective and cause leaks after the SureStart period, CertainTeed's maximum contribution toward the cost of repairing or replacing such defective shingles shall not exceed \$350/square, less 1/600th of that amount times the number of months from the date the shingles were originally installed to the date when CertainTeed determined the shingles to be defective. Labor costs, roof tear-off, metal work, flashing and disposal expenses, and other costs or expenses incurred during such repair or replacement are not covered or reimbursed by this Limited Warranty.

Transferability

The Limited Warranty for Symphony shingles may only be transferred by the original property owner/consumer to a subsequent property owner one (1) time in the first two (2) years after original installation. The warranty transfer is only effective if the subsequent property owner provides written notice of the transfer to CertainTeed within sixty (60) days from the real estate transfer date. (A warranty transfer request must be sent to RPG Technical Services Department, 20 Moores Road, Malvern, PA 19355.) After two (2) years, this Limited Warranty is not transferable.

Limitations

This Limited Warranty does not provide protection against and CertainTeed will have no liability for any failure, defect or damage caused by situations and events beyond normal exposure conditions, including but not limited to:

- Winds, including gusts, greater than 90 mph, lightning, hurricane (see “Limited Wind Warranty” section for hurricane wind exception), tornado, hailstorm, earthquake, fire, explosion, flood or falling objects.
- Distortion, cracking or other failure or movement of the base material over which the shingles are applied, of the roof deck, or of the walls or foundation of the building itself.
- Damage caused by structural changes, alterations or additions, or by the installation of equipment (such as aerials, signs or air-conditioning equipment) to the structure after the original shingles have been applied.
- Shading, stains or discoloration to the shingles arising from outside sources such as but not limited to the sun, algae, fungus, moss, lichens or other vegetation, mold or mildew growth, or paints, chemicals or other similar materials.
- Misuse, abuse, neglect, or improper transportation, handling or storage of the shingles.
- Installation of the shingles over non-approved roof decks as more fully explained in the CertainTeed Symphony installation instructions.
- Improper installation or installation not in accordance with CertainTeed’s written installation instructions applicable at the time of original installation.
- Damage to the shingles, the roof deck or the structure caused by ice backup or ice damming.
- Distortion or warping due to excessive or unusual heat sources, including without limitation, window reflections and heat buildup caused by inadequate roof ventilation.
- Vandalism or acts of war.
- Any other cause not a result of a manufacturing defect in the shingles.

Mold and mildew are functions of environmental conditions and are not manufacturing defects. As such, mold and mildew are not covered by this Limited Warranty or any implied warranty.

CertainTeed reserves the right to discontinue or modify any of its products, including the color of its shingles, and shall not be liable as a result of such discontinuance or modification, nor shall CertainTeed be liable in the event replacement material varies in color in comparison to the original product as a result of normal weathering. If CertainTeed replaces any material under this warranty, it may substitute products designated by CertainTeed to be of comparable quality or price range in the event the product initially installed has been discontinued or modified.

Inadequately Ventilated and Non-Ventilated Decks

Any shingles applied to inadequately ventilated or non-ventilated decks, other than the shingles and deck systems described in the section titled “Insulated Decks and Radiant Barriers,” are subject to a reduced limited warranty period of ten (10) years. Shingle damage or defects related to the absence of adequate roof system ventilation do not qualify for SureStart protection, and are limited to ten (10) years of Beyond SureStart coverage.

Insulated Decks and Radiant Barriers

CertainTeed’s Limited Warranty, including SureStart coverage, will remain in force when Symphony shingles are applied to roof deck assemblies (slopes $\geq 3:12$) where foam insulation is prefabricated into the roof deck system (often called “nailboard insulation”), where insulation is installed beneath an acceptable roof deck system, or where radiant barriers are installed, with or without ventilation directly below the deck. Acceptable roof deck surfaces must consist of at least 3/8” thick plywood or 7/16” thick OSB. If a different deck surface material will be utilized, please contact CertainTeed’s Technical Services Department for assistance. See the following important restrictions.

The design professional is responsible for ensuring 1) proper quality and application of the insulation and/or radiant barrier; 2) provision of adequate structural ventilation and/or vapor retarders as determined to be necessary, and 3) that all local codes are met (particularly taking into account local climate conditions). Special attention must be taken if cellular foam, fiber glass, cellulose insulations or other highly-permeable insulation will be used in an unventilated system, or if the insulation/rafter or insulation/joist planes may create an air leak that could lead to moisture transmission and condensation problems.

*All these important factors and decisions, while **not** the responsibility of CertainTeed Corporation, are critical to assure proper deck system performance.*

Ventilated Nail-Base Roof Insulation

Ventilated nail-base roof insulation products consist of rigid insulation (typically foam board) and another layer of material that provides air space above the insulation and below the nailable deck (which is typically at least 7/16” thick OSB or minimum 3/8” plywood). These products can provide soffit-to-ridge ventilation over cathedral-type ceilings, and if used and installed properly will not reduce the scope or length of CertainTeed’s Limited Warranty coverage period. It is important to follow the deck manufacturer’s instructions to achieve sufficient ventilation. CertainTeed offers FlintBoard™ CV – cross-ventilating insulation boards with 1”, 1-1/2”, or 2” air channels.

Limited Wind Warranty

CertainTeed warrants Symphony shingles to resist blow-off damage due to wind velocities, including gusts and hurricane winds, up to 90 mph during the first five (5) years following original installation.

If any blow-off damage occurs in the first five (5) years following original installation, CertainTeed will replace all damaged shingles without charge. CertainTeed will not be responsible for or reimburse labor costs or any other costs incurred during removal or replacement of damaged shingles. Such costs or damages are the property owner’s responsibility (and may be covered by homeowner’s insurance).

LIMITED WARRANTY AND LIMITATION OF REMEDIES

THE OBLIGATIONS CONTAINED IN THIS LIMITED WARRANTY CONSTITUTE THE EXCLUSIVE REMEDY AND ARE EXPRESSLY IN LIEU OF ANY AND ALL OTHER OBLIGATIONS, GUARANTEES AND WARRANTIES. APPLICABLE STATE LAW WILL DETERMINE THE PERIOD OF TIME FOLLOWING THE SALE THAT A PROPERTY OWNER/CONSUMER MAY SEEK A REMEDY UNDER THE IMPLIED WARRANTY OF MERCHANTABILITY OR FITNESS FOR A PARTICULAR PURPOSE. CERTAINTEED’S OBLIGATIONS, RESPONSIBILITIES, AND/OR LIABILITY SHALL BE LIMITED TO REPAIRING OR REPLACING THE DEFECTIVE PRODUCT OR PROVIDING A REFUND PER THE TERMS OF THIS LIMITED WARRANTY. IN NO EVENT SHALL CERTAINTEED BE LIABLE FOR ANY INCIDENTAL OR CONSEQUENTIAL DAMAGES, INCLUDING ANY DAMAGE TO THE BUILDING, ITS CONTENTS, OR ANY PERSONS OR PROPERTY, THAT OCCUR AS A RESULT OF A BREACH. IF YOUR STATE DOES NOT ALLOW EXCLUSIONS OR LIMITATIONS OF INCIDENTAL OR CONSEQUENTIAL DAMAGES, THE ABOVE LIMITATIONS MAY NOT APPLY TO YOU.

This warranty applies to Symphony shingles installed during the calendar year of 2017.

ASPHALT SHINGLE PRODUCTS

2018 Limited Warranty



CertainTeed
SAINT-GOBAIN

Congratulations... and thank you for your recent purchase of one of the fine products from CertainTeed Roofing. Since 1904, CertainTeed has been producing quality roofing products that provide long-lasting beauty and protection for homes of every size, style and age. For over 100 years, the basis for our name, "Quality made certain, satisfaction guaranteed," has been our ongoing philosophy.

Your CertainTeed roofing warranty fully explains how CertainTeed supports its products with the strongest warranty protection available. It is important that you read the warranty section of this brochure. The warranty lists the specific CertainTeed asphalt shingle products that are covered and the period of time for which they are covered. Take the time to understand how CertainTeed protects your purchase by standing behind our products.

Limited, Prorated and Transferable Warranty

This warranty covers asphalt shingle products listed in Table 1, sold only in the United States of America, its territories and Canada.

What and Who Are Covered and for How Long

From the date of installation, CertainTeed warrants to the original property owner/consumer that, when subject to normal and proper use, its shingles will be free from manufacturing defects for the warranty period specified in Table 1. CertainTeed will pay to repair, replace or clean, at its option, any shingles CertainTeed determines are defective under the terms of this Limited Warranty. In the event of repair, replacement or cleaning pursuant to the terms of this Limited Warranty, the warranty applicable to the original shingles shall apply to the repaired, replaced or cleaned shingles and will extend for the balance of the original warranty period.

Lifetime means for as long as the original individual home owner owns the property where the shingles are installed.

The Lifetime warranty period offered for certain shingles in Table 1 is only available to individual homeowners. The warranty period for shingles installed on premises not used by individual homeowners as their residence is limited as specified in Table 1. All property owners, who are not individual homeowners, and all structures not used by individual homeowners as their residence (e.g. corporations, governmental agencies, partnerships, trusts, religious organizations, schools, condominiums, homeowner associations or cooperative housing arrangements, apartment buildings, and any other type of building or premises not owned by individual homeowners) called "Other Ownership" are limited to either a 50-year or 40-year warranty period described in Table 1. In addition, for Other Ownership after the SureStart™ Protection period ends, this Limited Warranty covers only manufacturing defects that caused water penetration.

SureStart™ Protection

Because CertainTeed roofing products are manufactured to the highest quality standards, we confidently include the additional assurance of SureStart™ protection. SureStart provides the strongest non prorated protection you can get in the vital early years of your new roof.

All of CertainTeed's shingle products are covered by SureStart protection. Under this warranty feature, CertainTeed, at no charge, will pay to repair or replace, at its option, any shingles CertainTeed determines are defective during the SureStart period. Note: Wind warranty and algae warranty are covered separately as described on page 5. The SureStart period begins on the date of application and terminates following the warranty period specified in Table 1. CertainTeed's maximum liability under SureStart is equal to the reasonable cost of comparable replacement shingles and labor as determined by CertainTeed to replace or repair the defective shingles. Roof tear-off, metal work, flashing and disposal expenses, and other costs or expenses incurred during such repair or replacement are not covered or reimbursed by this Limited Warranty, except for certain products with Lifetime warranty periods specified in Table 1, for which CertainTeed's maximum liability also includes the cost of roof tear-off, metal work, flashing and disposal.

In instances in which CertainTeed, under the terms of this warranty, has agreed to pay the reasonable cost of labor required to repair or replace defective shingles, CertainTeed will determine labor costs by Bluebook® or RS Means® data. CertainTeed will provide reimbursement for labor only upon receipt of a copy of the contractor's invoice or other written evidence of the completion of such work which CertainTeed, in its sole discretion, deems acceptable.

Costs associated with removal or replacement of overburden (items installed over the shingles, including but not limited to, solar panels, satellite dishes and gardens) are the sole responsibility of the property owner.

SureStart protection does not extend to any shingles applied to non-ventilated or inadequately ventilated roof deck systems as determined by CertainTeed, except as stated on page 4. CertainTeed's maximum contribution toward the cost of repairing or replacing defective shingles applied to a non-ventilated or inadequately ventilated roof deck system is calculated using the reasonable cost of comparable replacement shingles as determined by CertainTeed less 1/120th of that amount multiplied by the number of months from the start of the warranty period to the date when CertainTeed determines the shingles are defective. Labor costs, roof tear-off, metal work, flashing and disposal expenses, and other costs or expenses incurred during such repair or replacement are not covered or reimbursed by this Limited Warranty.

Beyond SureStart™ Protection

After the SureStart Protection period, if CertainTeed determines its shingles have a manufacturing defect, or for Other Ownership, if CertainTeed determines its shingles have a manufacturing defect that caused water penetration, CertainTeed's maximum contribution toward the cost of repairing or replacing defective shingles will be calculated using the reasonable cost of comparable replacement shingles as determined by CertainTeed less the Reduction Figure Per Month, specified in Table 1, for the number of months from the start of the warranty period to the date when CertainTeed determines the shingles are defective. Labor costs, roof tear-off, metal work, flashing and disposal expenses, and other costs or expenses incurred during such repair or replacement are not covered or reimbursed by this Limited Warranty.

TABLE 1

<u>Lifetime Products^A</u>	<u>Warranty Period</u>	<u>SureStart Period</u>	<u>Wind Warranty Miles Per Hour</u>	<u>Algae Resistant Warranty Period¹</u>	<u>Reduction Figure Per Month</u>
Grand Manor® Arcadia Shake® Presidential Shake® TL Presidential Solaris® Landmark® TL Presidential Shake® (& IR) ² Carriage House® Belmont™ (& IR) ² Landmark® Premium Landmark Solaris® Landmark® PRO NorthGate® Highland Slate® (& IR) ² Independence®	Lifetime ^a	10 Years	110 ^{tt}	15	1/600*
<u>Lifetime Products^B</u>	<u>Warranty Period</u>	<u>SureStart Period</u>	<u>Wind Warranty Miles Per Hour</u>	<u>Algae Resistant Warranty Period¹</u>	<u>Reduction Figure Per Month</u>
Landmark® IR ²	Lifetime ^a	10 Years	110 ^{tt}	10	1/600*
Landmark®	Lifetime ^a	10 Years	110 ^{tt}	10	1/600*
<u>20 -, 25 - and 30 - Year Products</u>	<u>Warranty Period</u>	<u>SureStart Period</u>	<u>Wind Warranty Miles Per Hour</u>	<u>Algae Resistant Warranty Period¹</u>	<u>Reduction Figure Per Month</u>
Patriot	30 Years	8 Years	110	10	1/360
XT™ 30 IR ²	30 Years	5 Years	70	10	1/360
XT™ 25 ³	25 Years	5 Years	60	10	1/300
Any shingles applied to any inadequately ventilated roof deck <i>(see footnotes to Table 1 on the next page)</i>	10 years ¹	N/A	N/A	N/A	1/120

FOOTNOTES TO TABLE 1.

A. The Lifetime Warranty period is only available to individual homeowners on premises used as their residence. The warranty period for Other Ownership for these shingles is limited to 50 years and the SureStart period is 10 years following the installation of the shingles. Roof tear-off, metal work, flashing and disposal expense, incurred during repair or replacement are covered or reimbursed by this Limited Warranty. Limited Warranty transferees during the SureStart™ period are limited to a 50-year warranty period (see section titled "Transfers During the SureStart Period" for details).

B. The Lifetime Warranty period is only available to individual homeowners on premises used as their residence. The warranty period for Other Ownership for these shingles is limited to 40 years and the SureStart period is 5 years following the installation of the shingles. Limited Warranty transferees during the SureStart period are limited to a 40-year warranty period (see section titled "Transfers During the SureStart Period" for details).

* For Lifetime products, at the completion of the 40th year the reduction figure will remain at 480/600, or 20% of the total maximum liability.

† For details of warranty coverage for shingles installed on inadequately ventilated roof decks on both residential and commercial buildings, see provisions under "Inadequately Ventilated and Non-Ventilated Decks."

†† Wind warranty upgrade – These products are warranted to resist blow-off due to wind velocities, including gusts, up to a maximum of 130 miles per hour during the first fifteen (15) years, provided all of the following conditions are met:

1. The CertainTeed shingles are not applied over existing roof shingles (roof-overs are not permitted).
2. The CertainTeed specified corresponding hip and ridge accessory products are installed as cap shingles (Shadow Ridge®, Cedar Crest®, Shangle Ridge®, Mountain Ridge® Landmark Solaris® (& IR) and Hatteras®).
3. The CertainTeed specified corresponding starter shingles are installed along the roof eaves and rakes (Swiftstart®, High-Performance Starter and Presidential® Starter).

(Note: In Florida, CertainTeed will waive the requirement of applying starter shingles along the roof rake if all of the following conditions are met: The applicable building code requires that asphalt roof shingles be embedded in an 8-inch-wide bed of asphalt roofing cement applied along the roof rake edges. And, the shingles are installed and embedded in an 8-inch-wide bed of asphalt roofing cement along the roof rake edges in accordance with the code.)

¹Algae Resistant Warranty period applies only to the Algae Resistant (AR) version of the pertinent shingle.

²CertainTeed's Impact Resistant (IR) versions of Landmark®, Presidential Shake®, Belmont™, Highland Slate®, and XT™ 30 shingles comply with UL 2218 Impact Resistance of Prepared Roof Covering Materials test criteria at time of manufacture.

³The wind warranty for XT™ 25 shingles installed in Alaska is 90 mph.

Transferability

This Limited Warranty is transferable, but only by the original property owner/consumer to the first subsequent property owner. After the Limited Warranty has been transferred once, it is no longer transferable. A bank foreclosure or a change of ownership on a deed is deemed a transfer under this Limited Warranty.

Transfers During the SureStart™ Period

If this Limited Warranty is transferred during the product's SureStart period, the warranty for the new owner is the same as it would have been for the original owner, except for certain products with Lifetime warranty periods where the duration of the transferred warranty will be 50 years or 40 years as specified in Table 1, measured from the beginning of the SureStart period (i.e. the date of installation), and the remaining period of SureStart protection will be available to the subsequent property owner.

Transfers After the SureStart Period

If this Limited Warranty is transferred by the original property owner/consumer after the SureStart period, the warranty following the transfer will be limited to two (2) years from the date of the transfer. The warranty obligation will be calculated as explained in the section titled "Beyond SureStart Protection."

Limitations

This Limited Warranty does not provide protection against, and CertainTeed will have no liability for, any failure, defect or damage as a result of, including but not limited to:

- Winds, including gusts, greater than the Wind Warranty MPH in Table 1
- Damage caused by lightning, hailstorm, earthquake, fire, explosion, flood or falling objects.
- Damage caused by tornado, or hurricanes (other than as warranted under Wind Warranty MPH in Table 1).
- Distortion, cracking or other failure or movement of: the base material over which the shingles are applied, the roof deck, or the walls or foundation of the building itself.
- Damage caused by structural changes, alterations or additions, or by the installation of equipment (such as, but not limited to, aerials, signs or air-conditioning equipment) to the building after the original shingles have been applied.

- Shading, stains or discoloration to the shingles arising from outside sources such as, but not limited to, algae (unless blue-green algae as described in the section titled "Limited Algae Warranty"), fungus, moss, lichens or other vegetation, mold or mildew growth, or paints, chemicals or other similar materials.
- Misuse, abuse, neglect, or improper transportation, handling or storage of the shingles.
- Installation of the shingles over non-approved roof decks as more fully explained in CertainTeed's installation instructions published at the time of original installation.
- Damage caused by improper installation or installation not in accordance with CertainTeed's installation instructions published at the time of original installation.
- Damage to the shingles, the roof deck or the structure caused by ice backup or ice damming.
- Damage caused by impact, including such things as tools, equipment or foot traffic.
- Vandalism or acts of war.
- Animals, animal feces or insects.
- Any other cause not a result of a manufacturing defect in the shingles.

Mold and mildew are functions of environmental conditions and are not manufacturing defects. As such, mold and mildew are not covered by this Limited Warranty or any implied warranty.

CertainTeed reserves the right to discontinue or modify any of its products, including the color of its shingles, and shall not be liable as a result of such discontinuance or modification, nor shall CertainTeed be liable in the event replacement material varies in color in comparison to the original product as a result of normal weathering. If CertainTeed replaces any material under this warranty, it may substitute products designated by CertainTeed to be of comparable quality or price range in the event the product initially installed has been discontinued or modified.

Inadequately Ventilated and Non-Ventilated Decks

Any shingles applied to inadequately ventilated or non-ventilated decks, other than the shingles and deck systems described in the section titled "Insulated Decks and Radiant Barriers," are subject to a reduced limited warranty period of ten (10) years and do not qualify for SureStart Protection. **SureStart™ Protection and the Warranty Period applicable to the shingle are available if CertainTeed determines that the shingle damage was caused exclusively by a manufacturing defect that is unrelated to the inadequate roof system ventilation.**

Insulated Decks and Radiant Barriers

CertainTeed's Limited Warranty, including SureStart Protection, will remain in force when its fiber glass shingles are applied to roof deck assemblies where foam insulation is prefabricated into the roof deck system (often called "nailboard insulation"), where insulation is installed beneath an acceptable roof deck system, or where radiant barriers are installed, with or without ventilation, directly below the deck. Acceptable roof deck surfaces must consist of at least 3/8" thick plywood or 7/16" thick Oriented Strand Board (OSB) and slopes must be 2:12 or greater. If a different deck surface material will be utilized, please contact CertainTeed's Technical Services Department for assistance. (See the following important restrictions.)

The design professional is responsible for ensuring: 1) the proper quality and application of the insulation and/or radiant barrier, 2) the provision of adequate structural ventilation and/or vapor retarders as determined to be necessary, and 3) that all local codes are met (particularly taking into account local climate conditions). Special attention must be taken if cellular foam, fiber glass, cellulose insulation or other highly permeable insulation will be used in an unventilated system, or if the insulation/rafter or insulation/joist planes may create an air leak that could lead to moisture transmission and condensation problems. All these important factors and decisions, while not the responsibility of CertainTeed, are critical to assure proper deck system performance.

Ventilated Nail-Base Roof Insulation

Ventilated Nail-Base Roof Insulation products (e.g. FlintBoard® CV) are made of rigid insulation (typically foam board) and another layer of material that provides air space above the insulation and below the nailable deck (which is typically at least 7/16" thick OSB or 3/8" thick plywood). These products can provide soffit-to-ridge ventilation, and if installed in accordance with the deck manufacturer's instructions to achieve sufficient ventilation, will not reduce the scope or length of CertainTeed's Limited Warranty coverage.

Limited Algae-Resistant Warranty

Blue-green algae, which is commonly but incorrectly called “fungus,” can create unsightly streaking on shingles. CertainTeed warrants that the Algae-Resistant (AR) versions of the products in Table 1 will remain free from blue-green algae growth (but not mold or mildew growth) which adversely affects the overall appearance of said shingles for a period of ten (10) or fifteen (15) years, as noted in Table 1.

If during the Algae-Resistant Warranty Period specified in Table 1, the overall appearance of the Algae-Resistant shingles is adversely affected by blue-green algae, CertainTeed will pay the reasonable cost to replace or clean at its option, any affected shingles. In the event of replacement or cleaning, for the remainder of the Algae-Resistant Warranty Period, CertainTeed’s maximum contribution towards subsequent replacement or cleaning will be calculated using the Algae-Resistant Warranty Period specified in Table 1, less a prorated adjustment that reflects the number of months that have elapsed from the start of the Algae-Resistant Warranty Period to the date of reoccurrence.

WARNING: FOR LOW-VOLUME RAIN AND SALT FOG AREAS

In areas of low-volume rain (e.g. areas that receive insignificant rainfall during a 90-day period) and/or “salt fog” (e.g. parts of the Southern California coastline), copper released by algae-resistant (AR) granules or shingles can react with aluminum in gutters and cause severe corrosion of the gutters. In such regions, CertainTeed strongly recommends that vinyl or copper gutters, not aluminum gutters, be used with algae-resistant shingles. CertainTeed disclaims all liability and responsibility for any damages that may result from the use of its algae-resistant shingle products with copper granules where gutters containing aluminum are used.

Limited Wind Warranty

CertainTeed warrants its shingles will resist blow-off damage due to wind velocities, including gusts, up to the maximum wind velocity per the Wind Warranty MPH specified in Table 1 during the first fifteen (15) years of the warranty for Lifetime products and Patriot shingles for the first ten (10) years and during the first five (5) years for all other products listed in Table 1.

CertainTeed’s obligations and liability for shingle blow-off damage during the wind warranty periods as specified above are limited as follows:

- If shingles blow off because the shingle’s self-sealing asphalt strips did not activate, CertainTeed will have no liability or warranty obligation unless CertainTeed is afforded the opportunity to hand seal, at its expense, any non-sealing shingles.
- If shingles blow off even though the shingle’s self-sealing asphalt strips did activate, CertainTeed will furnish replacement shingles without charge, but only for damaged or blown off shingles. CertainTeed will not be responsible for or reimburse labor costs, roof tear-off, metal work, flashing and disposal expenses, or any other costs pertaining to removal or replacement of damaged shingles. Any costs in excess of CertainTeed’s material contribution are the property owner’s responsibility (and may be covered by homeowner’s insurance).
- CertainTeed shall have no liability for any shingles not fastened in accordance with CertainTeed installation instructions published at the time of original installation.
- CertainTeed shall have no liability for any damage to persons or property caused by blown off shingles.
- CertainTeed’s maximum liability during the wind warranty period is the reasonable cost of hand sealing all of the shingles on the roof.

Flintlastic® SA (Self-Adhering) System

For low slope residential roofing projects less than 2000 square feet (20 squares), CertainTeed offers a limited roof membrane warranty as follows: A 10-year warranty duration on a single ply of Flintlastic SA Cap sheet over a primed plywood roof deck or a 12-year warranty duration for a two-ply system consisting of a Flintlastic SA Nail Base and a Flintlastic SA Cap sheet, provided the Flintlastic products were applied in accordance with CertainTeed’s current installation instructions published at the time of installation.

CertainTeed warrants the roof membrane, subject to the following terms, conditions, limitations, and exclusions, for the duration specified above from the date of completion of the roof membrane installation. If during the duration of this Limited Warranty, a manufacturing defect in the roof membrane causes a leak, CertainTeed or its designated roofing contractor will,

at CertainTeed's sole discretion, repair or replace the roof membrane materials only as necessary to restore it to a watertight condition.

Only manufacturing defects in the roof membrane that cause leaks are covered by this Limited Warranty. CertainTeed's MAXIMUM LIABILITY during the first year of this warranty is the original cost of the CertainTeed membrane materials only. After the first year, CertainTeed's maximum liability is the original cost of the CertainTeed materials used on the roof reduced by 8.3% for 12-year warranty and 10% for 10-year warranty during each subsequent year, less any costs previously incurred by CertainTeed for repair or replacements.

Roof components which are not part of the roof membrane and hence not covered by this Limited Warranty include, but are not limited to, the following: underlying roof deck, insulation, vapor retarders, fasteners, metal work, drains, pitch pans, expansion joints, skylights, vents, plastic accessories, any flashing, decorative or reflective coating, surfacing and/or any aggregates. In no event, however, will CertainTeed be responsible for any costs related to the removal or abatement of any asbestos present in any existing roof system to which the CertainTeed roof membrane is applied.

What the Customer Must Do

If you believe your shingles have a manufacturing defect, you must promptly notify CertainTeed and provide proof of property ownership and the date of shingle purchase and application. Unless you provide such proof, CertainTeed will use the date of manufacture to calculate the start of the warranty period. In order to properly evaluate and process a warranty claim, CertainTeed may require the property owner to submit a shingle sample to CertainTeed for analysis and/or permit a CertainTeed representative to make repairs to, take photographs of, and/or take samples from the roof, if required. CertainTeed will evaluate each properly reported claim and will repair, replace, clean or reimburse the property owner for the shingles it determines are defective, in accordance with the terms of this Limited Warranty within a reasonable amount of time. For more details about submitting a warranty claim, visit www.ctroof.com or call (800) 345-1145.

Please send all notifications and correspondence to:

CertainTeed Corporation, 1508 Delp Drive, Harleysville, PA 19438.

Attn: CertainTeed Roofing Technical Services Department. Telephone number: 800-345-1145.

Warranty Registration (not required)

You may register your product warranty on CertainTeed's website:

www.certainteed.com/warrantyreg. Each registrant receives a registration confirmation number by return e-mail that can be printed and kept with this Limited Warranty and your proof of purchase. If you do not have internet access, you can register your shingles by sending: (1) your name, address, and telephone number; (2) the name and contact information of the contractor who installed your shingles and the original date of installation; and, (3) the type, color and number of squares of your shingles to: **CertainTeed Corporation, 20 Moores Road, Malvern, PA 19355, Attn: CertainTeed Roofing Technical Services Department.**

CertainTeed will register your information and mail you a confirmation number. Failure to register this warranty does NOT void the warranty or any of its terms.

For Your Records

Product Purchased: _____ Date of Installation: _____

Roofing Contractor: _____ Contractor's Telephone No. _____

This warranty applies to shingles installed during the calendar year of 2018.

(The warranty in effect at the time the material is originally installed is the applicable warranty.)

Exclusive Warranty and Limitation of Remedies

THIS DOCUMENT CONSTITUTES THE EXCLUSIVE WARRANTIES AND REMEDIES PROVIDED BY CERTAINTEED. THE WARRANTIES AND REMEDIES CONTAINED IN THIS DOCUMENT ARE EXPRESSLY IN LIEU OF ANY AND ALL OTHER OBLIGATIONS, GUARANTEES, WARRANTIES AND REPRESENTATIONS, WHETHER WRITTEN, ORAL OR IMPLIED BY STATUTE, AT LAW OR IN EQUITY, INCLUDING WITHOUT LIMITATION, THE IMPLIED WARRANTIES OF MERCHANTABILITY AND FITNESS FOR A PARTICULAR PURPOSE. SOME STATES OR PROVINCES MAY NOT ALLOW THE EXCLUSION OF IMPLIED WARRANTIES OR MAY DETERMINE THE PERIOD OF TIME FOLLOWING THE SALE THAT A PURCHASER MAY SEEK A REMEDY UNDER IMPLIED WARRANTIES, SO THE ABOVE EXCLUSION MAY NOT APPLY TO YOU.

CERTAINTEED'S OBLIGATIONS, RESPONSIBILITIES, AND LIABILITY SHALL BE LIMITED TO REPAIRING OR REPLACING THE DEFECTIVE PRODUCT OR CLEANING ALGAE-RESISTANT SHINGLES IN THE CASE OF ALGAE GROWTH AS SET FORTH IN THIS LIMITED WARRANTY. IN NO EVENT SHALL CERTAINTEED BE LIABLE FOR ANY SPECIAL, INDIRECT, INCIDENTAL OR CONSEQUENTIAL DAMAGES OF ANY KIND, INCLUDING ANY DAMAGE TO THE PROPERTY, THE BUILDING OR ITS CONTENTS, OR FOR INJURY TO ANY PERSONS, THAT MAY OCCUR AS A RESULT OF THE USE OF CERTAINTEED'S PRODUCTS OR AS A RESULT OF THE BREACH OF THIS WARRANTY. IF YOUR STATE OR PROVINCE DOES NOT ALLOW EXCLUSIONS OR LIMITATIONS OF SPECIAL, INDIRECT, INCIDENTAL OR CONSEQUENTIAL DAMAGES, THE ABOVE LIMITATIONS MAY NOT APPLY TO YOU.

IN NO EVENT SHALL CERTAINTEED'S TOTAL LIABILITY ARISING OUT OF OR RELATED TO THE PRODUCT(S) OR THIS LIMITED WARRANTY EXCEED THE REASONABLE COST OF SHINGLES AND LABOR TO REPLACE OR REPAIR THE DEFECTIVE SHINGLES.

This Limited Warranty may not be modified, altered or expanded by anyone, including product distributors, dealers, sellers and/or CertainTeed field representatives.

This Limited Warranty gives you specific legal rights, and you may also have other rights which vary from State to State, or Province to Province.

Roofing Plants and Regional Sales Office

CertainTeed roofing products are sold by CertainTeed Roofing in nine sales regions. They are manufactured in ten residential roofing plants and one commercial roofing plant. Since the early 1900s, CertainTeed Corporation has been an innovator in the building materials industry and today is a leading manufacturer of building materials including residential and commercial roofing, vinyl siding, composite decking and railing, fiber glass insulation and vinyl fence products. The company is headquartered in Malvern, Pennsylvania, and employs more than 7,000 employees at approximately 60 manufacturing facilities throughout North America. Continuing the 100-year commitment of "Quality made certain, Satisfaction guaranteed™," CertainTeed remains one of the most trusted names in the industry. More information is available at www.certainteed.com.

This document is also available in Spanish and French.

Call 1-800-782-8777 or go to www.certainteed.com.

Se puede obtener este documento en español. Favor de llamar 1-800-782-8777.

Ce document est disponible en anglais et en espagnol. Composez le 1-800-782-8777.



CertainTeed Corporation

ROOFING • SIDING • TRIM • DECKING • RAILING • FENCE • GYPSUM • CEILINGS • INSULATION
20 Moores Road Malvern, Pa 19355

Professional: 800-233-8990 Consumer: 800-782-8777 certainteed.com

CertainTeed

2018 Limited Warranty

Symphony™



ASK ABOUT ALL OF OUR OTHER CERTAINTEED® PRODUCTS AND SYSTEMS:

ROOFING • SIDING • TRIM • DECKING • RAILING • FENCE
GYPSUM • CEILINGS • INSULATION

www.certainteed.com <http://blog.certainteed.com>

CertainTeed Corporation
20 Moores Road
Malvern, PA 19355

Professional: 800-233-8990
Consumer: 800-782-8777

© CertainTeed Corporation, Printed in U.S.A.
Code No. 20-20-3694

1/2018



CertainTeed
SAINT-GOBAIN



Symphony™

*Where old-world elegance meets
new-world technology...in perfect harmony*

What the Customer Must Do

If you believe your shingles have a manufacturing defect, you must provide prompt written notification to CertainTeed with proof of the date of purchase and date of shingle application. CertainTeed will investigate each properly reported claim and will repair, replace or reimburse the homeowner for the shingles determined to be defective, in accordance with the terms of this Limited Warranty, within a reasonable amount of time if its inspection of the shingles confirms a manufacturing defect.

Please send all notifications and correspondence to:

CertainTeed Corporation, 20 Moores Road, Malvern, PA 19355

Attn: CertainTeed Roofing Technical Services Department, Telephone number: 800-345-1145

Warranty Registration (not required)

You may register your product warranty on CertainTeed's website: www.certainteed.com/warrantyreg. Each registrant receives a registration confirmation number by return e-mail that can be printed and kept with this Limited Warranty and your proof of purchase. If you do not have internet access, you can register your shingles by sending: (1) your name, address, and telephone number; (2) the name and contact information of the contractor who installed your shingles and the original date of installation; and (3) the type, color and number of squares of your shingles to:

CertainTeed Corporation, CertainTeed Roofing, 20 Moores Road, Malvern, PA 19355

CertainTeed will register your information and mail you a confirmation number. Failure to register this warranty does NOT void the warranty or any of its terms.

Roofing Plants and Regional Sales Offices

CertainTeed roofing products are sold by the CertainTeed Corporation in eight sales regions. They are manufactured in ten residential roofing plants and two commercial roofing plants.

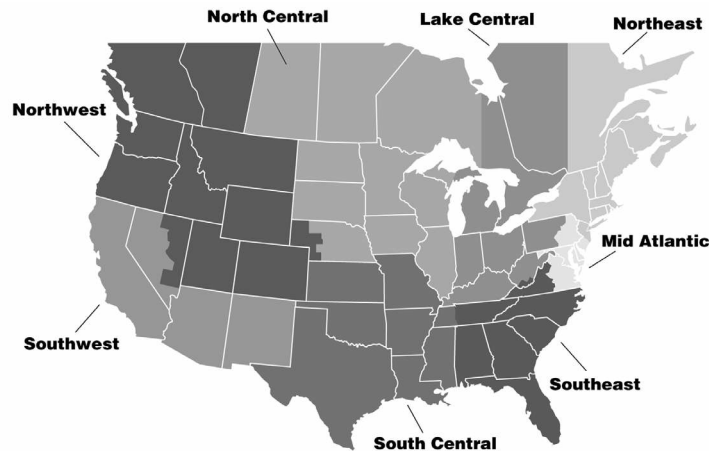

Through innovation and creative product design, CertainTeed has helped shape the building products industry for more than 100 years. Founded in 1904 as General Roofing Manufacturing Company, the firm made its slogan "*Quality made certain. Satisfaction guaranteed.*" which quickly inspired the name CertainTeed. Today, CertainTeed is North America's leading brand of exterior and interior building products, including roofing, siding, windows, fence, decking, railing, trim, foundations, pipe, insulation, walls, ceilings and access covers. Headquarter in Valley Forge, PA, CertainTeed and its affiliates have approximately 9,000 employees and 70 manufacturing facilities throughout the United States and Canada. More information is available at www.certainteed.com.

CONGRATULATIONS! ...and thank you for your recent purchase of one of the fine products produced by CertainTeed Roofing. Since 1904, CertainTeed has been producing quality roofing products that provide long-lasting beauty and protection for homes of every size, style and age. For the past 100 years, the basis for our name, "*Quality made certain, satisfaction guaranteed.*" has been our ongoing philosophy.

Your CertainTeed roofing warranty fully explains how CertainTeed supports its products with the strongest warranty protection available. It is important that you read the warranty section of this brochure. Take the time to understand how CertainTeed protects your purchase by standing behind our products.

LIMITED, PRORATED, AND TRANSFERABLE WARRANTY

This warranty covers Symphony™ sold only in the United States of America, its territories and Canada.

What and Who is Covered and for How Long

CertainTeed warrants to the original property owner/consumer that, when subject to normal and proper use, Symphony shingles will be free from manufacturing defects that cause leaks for fifty (50) years from the date of original installation and that CertainTeed will pay to repair or replace, at its option, any shingles CertainTeed determines to be defective under the terms of this Limited Warranty.

In the event of repair or replacement pursuant to the terms of this Limited Warranty, the original warranty applicable at the time of original installation shall apply to the replacement shingles or the repaired shingles.

SureStart™ Protection

All of CertainTeed's shingle products are covered by SureStart protection. Under this warranty feature, CertainTeed, at no charge, will pay to repair or replace, at its option, any shingles CertainTeed determines to be defective and that cause leaks during the applicable SureStart period. For Symphony shingles, the SureStart period begins when the original shingle installation has been completed and terminates at the completion of its seventh (7th) year of service following original installation. CertainTeed's maximum liability under SureStart is equal to the reasonable material and labor cost to replace or repair the defective shingles that cause leaks, as determined by CertainTeed. Roof tear-off, metal work, flashing and disposal expenses, and other costs or expenses incurred during such repair or replacement are not covered or reimbursed by this Limited Warranty.

SureStart protection does not extend to any Symphony shingles applied to any non-ventilated or inadequately ventilated roof deck systems, except as stated below. CertainTeed's maximum contribution toward the cost of repairing or replacing defective shingles applied to a non-ventilated or inadequately ventilated roof deck system shall not exceed \$350/square, less 1/120th of that amount times the number of months from the date the shingles were originally installed to the date when CertainTeed determined the shingles to be defective. Labor costs, roof tear-off, metal work, flashing and disposal expenses, and other costs or expenses incurred during such repair or replacement are not covered or reimbursed by this Limited Warranty.

Beyond SureStart™ Protection

If CertainTeed determines the Symphony shingles to be defective and cause leaks after the SureStart period, CertainTeed's maximum contribution toward the cost of repairing or replacing such defective shingles shall not exceed \$350/square, less 1/600th of that amount times the number of months from the date the shingles were originally installed to the date when CertainTeed determined the shingles to be defective. Labor costs, roof tear-off, metal work, flashing and disposal expenses, and other costs or expenses incurred during such repair or replacement are not covered or reimbursed by this Limited Warranty.

Transferability

The Limited Warranty for Symphony shingles may only be transferred by the original property owner/consumer to a subsequent property owner one (1) time in the first two (2) years after original installation. The warranty transfer is only effective if the subsequent property owner provides written notice of the transfer to CertainTeed within sixty (60) days from the real estate transfer date. (A warranty transfer request must be sent to RPG Technical Services Department, 20 Moores Road, Malvern, PA 19355.) After two (2) years, this Limited Warranty is not transferable.

Limitations

This Limited Warranty does not provide protection against and CertainTeed will have no liability for any failure, defect or damage caused by situations and events beyond normal exposure conditions, including but not limited to:

- Winds, including gusts, greater than 90 mph, lightning, hurricane (see “Limited Wind Warranty” section for hurricane wind exception), tornado, hailstorm, earthquake, fire, explosion, flood or falling objects.
- Distortion, cracking or other failure or movement of the base material over which the shingles are applied, of the roof deck, or of the walls or foundation of the building itself.
- Damage caused by structural changes, alterations or additions, or by the installation of equipment (such as aerials, signs or air-conditioning equipment) to the structure after the original shingles have been applied.
- Shading, stains or discoloration to the shingles arising from outside sources such as but not limited to the sun, algae, fungus, moss, lichens or other vegetation, mold or mildew growth, or paints, chemicals or other similar materials.
- Misuse, abuse, neglect, or improper transportation, handling or storage of the shingles.
- Installation of the shingles over non-approved roof decks as more fully explained in the CertainTeed Symphony installation instructions.
- Improper installation or installation not in accordance with CertainTeed’s written installation instructions applicable at the time of original installation.
- Damage to the shingles, the roof deck or the structure caused by ice backup or ice damming.
- Distortion or warping due to excessive or unusual heat sources, including without limitation, window reflections and heat buildup caused by inadequate roof ventilation.
- Vandalism or acts of war.
- Any other cause not a result of a manufacturing defect in the shingles.

Mold and mildew are functions of environmental conditions and are not manufacturing defects. As such, mold and mildew are not covered by this Limited Warranty or any implied warranty.

CertainTeed reserves the right to discontinue or modify any of its products, including the color of its shingles, and shall not be liable as a result of such discontinuance or modification, nor shall CertainTeed be liable in the event replacement material varies in color in comparison to the original product as a result of normal weathering. If CertainTeed replaces any material under this warranty, it may substitute products designated by CertainTeed to be of comparable quality or price range in the event the product initially installed has been discontinued or modified.

Inadequately Ventilated and Non-Ventilated Decks

Any shingles applied to inadequately ventilated or non-ventilated decks, other than the shingles and deck systems described in the section titled “Insulated Decks and Radiant Barriers,” are subject to a reduced limited warranty period of ten (10) years. Shingle damage or defects related to the absence of adequate roof system ventilation do not qualify for SureStart protection, and are limited to ten (10) years of Beyond SureStart coverage.

Insulated Decks and Radiant Barriers

CertainTeed’s Limited Warranty, including SureStart coverage, will remain in force when Symphony shingles are applied to roof deck assemblies (slopes \geq 3:12) where foam insulation is prefabricated into the roof deck system (often called “nailboard insulation”), where insulation is installed beneath an acceptable roof deck system, or where radiant barriers are installed, with or without ventilation directly below the deck. Acceptable roof deck surfaces must consist of at least 3/8” thick plywood or 7/16” thick OSB. If a different deck surface material will be utilized, please contact CertainTeed’s Technical Services Department for assistance. See the following important restrictions.

The design professional is responsible for ensuring 1) proper quality and application of the insulation and/or radiant barrier; 2) provision of adequate structural ventilation and/or vapor retarders as determined to be necessary, and 3) that all local codes are met (particularly taking into account local climate conditions). Special attention must be taken if cellular foam, fiber glass, cellulose insulations or other highly-permeable insulation will be used in an unventilated system, or if the insulation/rafter or insulation/joist planes may create an air leak that could lead to moisture transmission and condensation problems.

*All these important factors and decisions, while **not** the responsibility of CertainTeed Corporation, are critical to assure proper deck system performance.*

Ventilated Nail-Base Roof Insulation

Ventilated nail-base roof insulation products consist of rigid insulation (typically foam board) and another layer of material that provides air space above the insulation and below the nailable deck (which is typically at least 7/16” thick OSB or minimum 3/8” plywood). These products can provide soffit-to-ridge ventilation over cathedral-type ceilings, and if used and installed properly will not reduce the scope or length of CertainTeed’s Limited Warranty coverage period. It is important to follow the deck manufacturer’s instructions to achieve sufficient ventilation. CertainTeed offers FlintBoard™ CV – cross-ventilating insulation boards with 1”, 1-1/2”, or 2” air channels.

Limited Wind Warranty

CertainTeed warrants Symphony shingles to resist blow-off damage due to wind velocities, including gusts and hurricane winds, up to 90 mph during the first five (5) years following original installation.

If any blow-off damage occurs in the first five (5) years following original installation, CertainTeed will replace all damaged shingles without charge. CertainTeed will not be responsible for or reimburse labor costs or any other costs incurred during removal or replacement of damaged shingles. Such costs or damages are the property owner’s responsibility (and may be covered by homeowner’s insurance).

LIMITED WARRANTY AND LIMITATION OF REMEDIES

THE OBLIGATIONS CONTAINED IN THIS LIMITED WARRANTY CONSTITUTE THE EXCLUSIVE REMEDY AND ARE EXPRESSLY IN LIEU OF ANY AND ALL OTHER OBLIGATIONS, GUARANTEES AND WARRANTIES. APPLICABLE STATE LAW WILL DETERMINE THE PERIOD OF TIME FOLLOWING THE SALE THAT A PROPERTY OWNER/CONSUMER MAY SEEK A REMEDY UNDER THE IMPLIED WARRANTY OF MERCHANTABILITY OR FITNESS FOR A PARTICULAR PURPOSE. CERTAINTEED’S OBLIGATIONS, RESPONSIBILITIES, AND/OR LIABILITY SHALL BE LIMITED TO REPAIRING OR REPLACING THE DEFECTIVE PRODUCT OR PROVIDING A REFUND PER THE TERMS OF THIS LIMITED WARRANTY. IN NO EVENT SHALL CERTAINTEED BE LIABLE FOR ANY INCIDENTAL OR CONSEQUENTIAL DAMAGES, INCLUDING ANY DAMAGE TO THE BUILDING, ITS CONTENTS, OR ANY PERSONS OR PROPERTY, THAT OCCUR AS A RESULT OF A BREACH. IF YOUR STATE DOES NOT ALLOW EXCLUSIONS OR LIMITATIONS OF INCIDENTAL OR CONSEQUENTIAL DAMAGES, THE ABOVE LIMITATIONS MAY NOT APPLY TO YOU.

This warranty applies to Symphony shingles installed during the calendar year of 2017.

CERTAINTEED'S OBLIGATIONS, RESPONSIBILITIES, AND LIABILITY SHALL BE LIMITED TO REPAIRING OR REPLACING THE DEFECTIVE PRODUCT OR CLEANING ALGAE-RESISTANT SHINGLES IN THE CASE OF ALGAE GROWTH AS SET FORTH IN THIS LIMITED WARRANTY. IN NO EVENT SHALL CERTAINTEED BE LIABLE FOR ANY SPECIAL, INDIRECT, INCIDENTAL OR CONSEQUENTIAL DAMAGES OF ANY KIND, INCLUDING ANY DAMAGE TO THE PROPERTY, THE BUILDING OR ITS CONTENTS, OR FOR INJURY TO ANY PERSONS, THAT MAY OCCUR AS A RESULT OF THE USE OF CERTAINTEED'S PRODUCTS OR AS A RESULT OF THE BREACH OF THIS WARRANTY. IF YOUR STATE OR PROVINCE DOES NOT ALLOW EXCLUSIONS OR LIMITATIONS OF SPECIAL, INDIRECT, INCIDENTAL OR CONSEQUENTIAL DAMAGES, THE ABOVE LIMITATIONS MAY NOT APPLY TO YOU.

IN NO EVENT SHALL CERTAINTEED'S TOTAL LIABILITY ARISING OUT OF OR RELATED TO THE PRODUCT(S) OR THIS LIMITED WARRANTY EXCEED THE REASONABLE COST OF SHINGLES AND LABOR TO REPLACE OR REPAIR THE DEFECTIVE SHINGLES.

This Limited Warranty may not be modified, altered or expanded by anyone, including product distributors, dealers, sellers and/or CertainTeed field representatives.

This Limited Warranty gives you specific legal rights, and you may also have other rights which vary from State to State, or Province to Province.

Roofing Plants and Regional Sales Office

CertainTeed roofing products are sold by CertainTeed Roofing in nine sales regions. They are manufactured in ten residential roofing plants and one commercial roofing plant. Since the early 1900s, CertainTeed Corporation has been an innovator in the building materials industry and today is a leading manufacturer of building materials including residential and commercial roofing, vinyl siding, composite decking and railing, fiber glass insulation and vinyl fence products. The company is headquartered in Malvern, Pennsylvania, and employs more than 7,000 employees at approximately 60 manufacturing facilities throughout North America. Continuing the 100-year commitment of "Quality made certain, Satisfaction guaranteed™," CertainTeed remains one of the most trusted names in the industry. More information is available at www.certainteed.com.

This document is also available in Spanish and French.

Call 1-800-782-8777 or go to www.certainteed.com.

Se puede obtener este documento en español. Favor de llamar 1-800-782-8777.

Ce document est disponible en anglais et en espagnol. Composez le 1-800-782-8777.

ASPHALT SHINGLE PRODUCTS

2019 Limited Warranty



CertainTeed Corporation

ROOFING • SIDING • TRIM • DECKING • RAILING • FENCE • GYPSUM • CEILINGS • INSULATION

20 Moores Road Malvern, PA 19355

Professional: 800-233-8990 Consumer: 800-782-8777 certainteed.com

© 01/19 CertainTeed Corporation, Printed in the USA, Code No. 20-20-3743

CertainTeed
SAINT-GOBAIN

Congratulations... and thank you for your recent purchase of one of the fine products from CertainTeed Roofing. Since 1904, CertainTeed has been producing quality roofing products that provide long-lasting beauty and protection for homes of every size, style and age. For over 100 years, the basis for our name, "Quality made certain, satisfaction guaranteed," has been our ongoing philosophy.

Your CertainTeed roofing warranty fully explains how CertainTeed supports its products with the strongest warranty protection available. It is important that you read the warranty section of this brochure. The warranty lists the specific CertainTeed asphalt shingle products that are covered and the period of time for which they are covered. Take the time to understand how CertainTeed protects your purchase by standing behind our products.

Limited, Prorated and Transferable Warranty

This warranty covers asphalt shingle products listed in Table 1, sold only in the United States of America, its territories and Canada.

What and Who Are Covered and for How Long

From the date of installation, CertainTeed warrants to the original property owner/consumer that, when subject to normal and proper use, its shingles will be free from manufacturing defects for the warranty period specified in Table 1. CertainTeed will pay to repair, replace or clean, at its option, any shingles CertainTeed determines are defective under the terms of this Limited Warranty. In the event of repair, replacement or cleaning pursuant to the terms of this Limited Warranty, the warranty applicable to the original shingles shall apply to the repaired, replaced or cleaned shingles and will extend for the balance of the original warranty period.

Lifetime means for as long as the original individual property owner owns the property where the shingles are installed.

The Lifetime warranty period offered for certain shingles in Table 1 is only available to individual property owners. The warranty period for shingles installed on premises not used by individual property owners as their residence is limited as specified in Table 1. All property owners, who are not individual property owners, and all structures not used by individual property owners as their residence (e.g. corporations, governmental agencies, partnerships, religious organizations, schools, condominiums, property owner associations or cooperative housing arrangements, apartment buildings, and any other type of building or premises not owned by individual property owners) called "Other Ownership" are limited to either a 50-year or 40-year warranty period described in Table 1. In addition, for Other Ownership after the SureStart™ Protection period ends, this Limited Warranty covers only manufacturing defects that caused water penetration.

SureStart™ Protection

Because CertainTeed roofing products are manufactured to the highest quality standards, we confidently include the additional assurance of SureStart™ protection. SureStart provides the strongest non-prorated protection you can get in the vital early years of your new roof.

All of CertainTeed's shingle products are covered by SureStart protection. Under this warranty feature, CertainTeed, at no charge, will pay to repair or replace, at its option, any shingles CertainTeed determines are defective during the SureStart period. Note: Wind warranty and algae warranty are covered separately as described on page 5. The SureStart period begins on the date of application and terminates following the warranty period specified in Table 1. CertainTeed's maximum liability under SureStart is equal to the reasonable cost of comparable replacement shingles and labor as determined by CertainTeed to replace or repair the defective shingles. Roof tear-off, metal work, flashing and disposal expenses, and other costs or expenses incurred during such repair or replacement are not covered or reimbursed by this Limited Warranty, except for certain products with Lifetime warranty periods specified in Table 1, for which CertainTeed's maximum liability also includes the cost of roof tear-off, metal work, flashing and disposal.

In instances in which CertainTeed, under the terms of this warranty, has agreed to pay the reasonable cost of labor required to repair or replace defective shingles, CertainTeed will determine labor costs by Bluebook® or RS Means® data. CertainTeed will provide reimbursement for labor only upon receipt of a copy of the contractor's invoice or other written evidence of the completion of such work which CertainTeed, in its sole discretion, deems acceptable.

Costs associated with removal or replacement of overburden (items installed over the shingles, including but not limited to, solar panels, satellite dishes and gardens) are the sole responsibility of the property owner.

SureStart protection does not extend to any shingles applied to non-ventilated or inadequately ventilated roof deck systems as determined by CertainTeed, except as stated on page 4. CertainTeed's maximum contribution toward the cost of repairing or replacing defective shingles applied to a non-ventilated or inadequately ventilated roof deck system is calculated using the reasonable cost of comparable replacement shingles as determined by CertainTeed less 1/120th of that amount multiplied by the number of months from the start of the warranty period to the date when CertainTeed determines the shingles are defective. Labor costs, roof tear-off, metal work, flashing and disposal expenses, and other costs or expenses incurred during such repair or replacement are not covered or reimbursed by this Limited Warranty.

Beyond SureStart™ Protection

After the SureStart Protection period, if CertainTeed determines its shingles have a manufacturing defect, or for Other Ownership, if CertainTeed determines its shingles have a manufacturing defect that caused water penetration, CertainTeed's maximum contribution toward the cost of repairing or replacing defective shingles will be calculated using the reasonable cost of comparable replacement shingles as determined by CertainTeed less the Reduction Figure Per Month, specified in Table 1, for the number of months from the start of the warranty period to the date when CertainTeed determines the shingles are defective. Labor costs, roof tear-off, metal work, flashing and disposal expenses, and other costs or expenses incurred during such repair or replacement are not covered or reimbursed by this Limited Warranty.

TABLE 1

<u>Lifetime Products^A</u>	<u>Warranty Period</u>	<u>SureStart Period</u>	<u>Wind Warranty Miles Per Hour</u>	<u>Algae Resistant Warranty Period¹</u>	<u>Reduction Figure Per Month</u>
Grand Manor® Arcadia Shake® Presidential Shake® TL Presidential Solaris® Landmark® TL Presidential Shake® (& IR) ² Carriage House® Belmont® (& IR) ² Landmark® Premium Landmark Solaris® Landmark® PRO NorthGate® Highland Slate® (& IR) ²	Lifetime ^a	10 Years	110 ^{tt}	15	1/600*

<u>Lifetime Products^B</u>	<u>Warranty Period</u>	<u>SureStart Period</u>	<u>Wind Warranty Miles Per Hour</u>	<u>Algae Resistant Warranty Period¹</u>	<u>Reduction Figure Per Month</u>
Landmark® IR ²	Lifetime ^a	10 Years	110 ^{tt}	10	1/600*
Landmark®	Lifetime ^a	10 Years	110 ^{tt}	10	1/600*

<u>20 - , 25 - and 30 - Year Products</u>	<u>Warranty Period</u>	<u>SureStart Period</u>	<u>Wind Warranty Miles Per Hour</u>	<u>Algae Resistant Warranty Period¹</u>	<u>Reduction Figure Per Month</u>
Patriot	30 Years	8 Years	110	10	1/360
XT™ 30 IR ²	30 Years	5 Years	70	10	1/360
XT™ 25 ³	25 Years	5 Years	60	10	1/300
CT™ 20	20 Years	3 Years	60		1/240

Any shingles applied to any inadequately ventilated roof deck <i>(see footnotes to Table 1 on the next page)</i>	10 years ¹	N/A	N/A	N/A	1/120
---	-----------------------	-----	-----	-----	-------

FOOTNOTES TO TABLE 1.

A. The Lifetime Warranty period is only available to individual property owners on premises used as their residence.

The warranty period for Other Ownership for these shingles is limited to 50 years and the SureStart period is 10 years following the installation of the shingles. Roof tear-off, metal work, flashing and disposal expense, incurred during repair or replacement are covered or reimbursed by this Limited Warranty. Limited Warranty transferees during the SureStart™ period are limited to a 50-year warranty period (see section titled “Transfers During the SureStart Period” for details).

B. The Lifetime Warranty period is only available to individual property owners on premises used as their residence.

The warranty period for Other Ownership for these shingles is limited to 40 years and the SureStart period is 5 years following the installation of the shingles. Limited Warranty transferees during the SureStart period are limited to a 40-year warranty period (see section titled “Transfers During the SureStart Period” for details).

* For Lifetime products, at the completion of the 40th year the reduction figure will remain at 480/600, or 20% of the total maximum liability.

† For details of warranty coverage for shingles installed on inadequately ventilated roof decks on both residential and commercial buildings, see provisions under “Inadequately Ventilated and Non-Ventilated Decks.”

†† Wind warranty upgrade – These products are warranted to resist blow-off due to wind velocities, including gusts, up to a maximum of 130 miles per hour during the first fifteen (15) years, provided all of the following conditions are met:

1. The CertainTeed shingles are not applied over existing roof shingles (roof-overs are not permitted).
2. The CertainTeed specified corresponding hip and ridge accessory products are installed as cap shingles [Shadow Ridge®, Cedar Crest®, Shangle Ridge®, Mountain Ridge® and Landmark Solaris® (& IR)].
3. The CertainTeed specified corresponding starter shingles are installed along the roof eaves and rakes (Swiftstart®, High-Performance Starter and Presidential® Starter).

(Note: In Florida, CertainTeed will waive the requirement of applying starter shingles along the roof rake if all of the following conditions are met: The applicable building code requires that asphalt roof shingles be embedded in an 8-inch-wide bed of asphalt roofing cement applied along the roof rake edges. And, the shingles are installed and embedded in an 8-inch-wide bed of asphalt roofing cement along the roof rake edges in accordance with the code.)

¹Algae Resistant Warranty period applies only to the Algae Resistant (AR) version of the pertinent shingle.

²CertainTeed’s Impact Resistant (IR) versions of Landmark®, Presidential Shake®, Belmont®, Highland Slate®, and XT™ 30 shingles comply with UL 2218 Impact Resistance of Prepared Roof Covering Materials test criteria at time of manufacture.

³The wind warranty for XT™ 25 shingles installed in Alaska is 90 mph.

Transferability

This Limited Warranty is transferable, but only by the original property owner/consumer to the first subsequent property owner. After the Limited Warranty has been transferred once, it is no longer transferable. A bank foreclosure or a change of ownership on a deed is deemed a transfer under this Limited Warranty.

Transfers During the SureStart™ Period

If this Limited Warranty is transferred during the product’s SureStart period, the warranty for the new owner is the same as it would have been for the original owner, except for certain products with Lifetime warranty periods where the duration of the transferred warranty will be 50 years or 40 years as specified in Table 1, measured from the beginning of the SureStart period (i.e. the date of installation), and the remaining period of SureStart protection will be available to the subsequent property owner.

Transfers After the SureStart Period

If this Limited Warranty is transferred by the original property owner/consumer after the SureStart period, the warranty following the transfer will be limited to two (2) years from the date of the transfer. The warranty obligation will be calculated as explained in the section titled “Beyond SureStart Protection.”

Limitations

This Limited Warranty does not provide protection against, and CertainTeed will have no liability for, any failure, defect or damage as a result of, including but not limited to:

- Winds, including gusts, greater than the Wind Warranty MPH in Table 1
- Damage caused by lightning, hailstorm, earthquake, fire, explosion, flood or falling objects.
- Damage caused by tornado, or hurricanes (other than as warranted under Wind Warranty MPH in Table 1).
- Distortion, cracking or other failure or movement of: the base material over which the shingles are applied, the roof deck, or the walls or foundation of the building itself.
- Damage caused by structural changes, alterations or additions, or by the installation of equipment (such as, but not limited to, aerials, signs or air-conditioning equipment) to the building after the original shingles have been applied.

- Shading, stains or discoloration to the shingles arising from outside sources such as, but not limited to, algae (unless blue-green algae as described in the section titled “Limited Algae Resistant Warranty”), fungus, moss, lichens or other vegetation, mold or mildew growth, or paints, chemicals or other similar materials.
- Misuse, abuse, neglect, or improper transportation, handling or storage of the shingles.
- Installation of the shingles over non-approved roof decks as more fully explained in CertainTeed’s installation instructions published at the time of original installation.
- Damage caused by improper installation or installation not in accordance with CertainTeed’s installation instructions published at the time of original installation.
- Damage to the shingles, the roof deck or the structure caused by ice backup or ice damming.
- Damage caused by impact, including such things as tools, equipment or foot traffic.
- Vandalism or acts of war.
- Animals, animal feces or insects.
- Any other cause not a result of a manufacturing defect in the shingles.

Mold and mildew are functions of environmental conditions and are not manufacturing defects. As such, mold and mildew are not covered by this Limited Warranty or any implied warranty.

CertainTeed reserves the right to discontinue or modify any of its products, including the color of its shingles, and shall not be liable as a result of such discontinuance or modification, nor shall CertainTeed be liable in the event replacement material varies in color in comparison to the original product as a result of normal weathering. If CertainTeed replaces any material under this warranty, it may substitute products designated by CertainTeed to be of comparable quality or price range in the event the product initially installed has been discontinued or modified.

Inadequately Ventilated and Non-Ventilated Decks

Any shingles applied to inadequately ventilated or non-ventilated decks, other than the shingles and deck systems described in the section titled “Insulated Decks and Radiant Barriers,” are subject to a reduced limited warranty period of ten (10) years and do not qualify for SureStart Protection. **SureStart™ Protection and the Warranty Period applicable to the shingle are available if** CertainTeed determines that the shingle damage was caused exclusively by a manufacturing defect that is unrelated to the inadequate roof system ventilation.

Insulated Decks and Radiant Barriers

CertainTeed’s Limited Warranty, including SureStart Protection, will remain in force when its fiberglass shingles are applied to roof deck assemblies where foam insulation is prefabricated into the roof deck system (often called “naillboard insulation”), where insulation is installed beneath an acceptable roof deck system, or where radiant barriers are installed, with or without ventilation, directly below the deck. Acceptable roof deck surfaces must consist of at least 3/8” thick plywood or 7/16” thick Oriented Strand Board (OSB) and slopes must be 2:12 or greater. If a different deck surface material will be utilized, please contact CertainTeed’s Technical Services Department for assistance. (See the following important restrictions.)

The design professional is responsible for ensuring: 1) the proper quality and application of the insulation and/or radiant barrier, 2) the provision of adequate structural ventilation and/or vapor retarders as determined to be necessary, and 3) that all local codes are met (particularly taking into account local climate conditions). Special attention must be taken if cellular foam, fiberglass, cellulose insulation or other highly permeable insulation will be used in an unventilated system, or if the insulation/rafter or insulation/joist planes may create an air leak that could lead to moisture transmission and condensation problems. All these important factors and decisions, while not the responsibility of CertainTeed, are critical to assure proper deck system performance.

Ventilated Nail-Base Roof Insulation

Ventilated Nail-Base Roof Insulation products (e.g. FlintBoard® CV) are made of rigid insulation (typically foam board) and another layer of material that provides air space above the insulation and below the nailable deck (which is typically at least 7/16” thick OSB or 3/8” thick plywood). These products can provide soffit-to-ridge ventilation, and if installed in accordance with the deck manufacturer’s instructions to achieve sufficient ventilation, will not reduce the scope or length of CertainTeed’s Limited Warranty coverage.

Limited Algae-Resistant Warranty

Blue-green algae or gloeocapsa magma, (which has a black/brown appearance and is commonly but incorrectly called "fungus"), can create unsightly streaking on shingles. CertainTeed warrants that the Algae-Resistant (AR) versions of the products in Table 1 will remain free from blue-green algae growth (but not mold or mildew growth) which adversely affects the overall appearance of said shingles for a period of ten (10) or fifteen (15) years, as noted in Table 1.

If during the Algae-Resistant Warranty Period specified in Table 1, the overall appearance of the Algae-Resistant shingles is adversely affected by blue-green algae, CertainTeed will pay the reasonable cost to replace or clean at its option, any affected shingles. In the event of replacement or cleaning, for the remainder of the Algae-Resistant Warranty Period, CertainTeed's maximum contribution towards subsequent replacement or cleaning will be calculated using the Algae-Resistant Warranty Period specified in Table 1, less a prorated adjustment that reflects the number of months that have elapsed from the start of the Algae-Resistant Warranty Period to the date of reoccurrence.

WARNING: FOR LOW-VOLUME RAIN AND SALT FOG AREAS

In areas of low-volume rain (e.g. areas that receive insignificant rainfall during a 90-day period) and/or "salt fog" (e.g. parts of the Southern California coastline), copper released by algae-resistant (AR) granules or shingles can react with aluminum in gutters and cause severe corrosion of the gutters. In such regions, CertainTeed strongly recommends that vinyl or copper gutters, not aluminum gutters, be used with algae-resistant shingles. CertainTeed disclaims all liability and responsibility for any damages that may result from the use of its algae-resistant shingle products with copper granules where gutters containing aluminum are used.

Limited Wind Warranty

CertainTeed warrants its shingles will resist blow-off damage due to wind velocities, including gusts, up to the maximum wind velocity per the Wind Warranty MPH specified in Table 1 during the first fifteen (15) years of the warranty for Lifetime products and during the first ten (10) years for Patriot shingles and during the first five (5) years for all other products listed in Table 1.

CertainTeed's obligations and liability for shingle blow-off damage during the wind warranty periods as specified above are limited as follows:

- If shingles or hip/ridge accessories blow off because the self-sealing asphalt strips did not activate, CertainTeed will furnish replacement shingles without charge, but only for damaged or blown off shingles.
- If shingles or hip/ridge accessories blow off before the self-sealing asphalt strips could have reasonably activated due to installation in cold weather, CertainTeed will furnish replacement shingles without charge, but only for damaged or blown off shingles. CertainTeed will not be responsible for or reimburse labor costs, roof tear-off, metal work, flashing and disposal expenses, or any other costs pertaining to removal or replacement of damaged shingles. Any costs in excess of CertainTeed's material contribution are the property owner's responsibility (and may be covered by owner's insurance).
- CertainTeed shall have no liability for any shingles not fastened in accordance with CertainTeed installation instructions published at the time of original installation.
- CertainTeed shall have no liability for any damage to persons or property caused by blown off shingles.
- CertainTeed's maximum liability during the Limited Wind Warranty period is the reasonable cost of hand sealing all of the shingles on the roof.

Flintlastic® SA (Self-Adhering) System

For low slope residential roofing projects less than 2000 square feet (20 squares), CertainTeed offers a limited roof membrane warranty as follows: A 10-year warranty duration on a single ply of Flintlastic SA Cap sheet over a primed plywood roof deck or a 12-year warranty duration for a two-ply system consisting of a Flintlastic SA Nail Base and a Flintlastic SA Cap sheet, provided the Flintlastic products were applied in accordance with CertainTeed's current installation instructions published at the time of installation.

CertainTeed warrants the roof membrane, subject to the following terms, conditions, limitations, and exclusions, for the duration specified above from the date of completion of the roof membrane installation. If during the duration of this Limited Warranty, a manufacturing defect in the roof membrane causes a leak, CertainTeed or its designated roofing contractor will,

at CertainTeed's sole discretion, repair or replace the roof membrane materials only as necessary to restore it to a watertight condition.

Only manufacturing defects in the roof membrane that cause leaks are covered by this Limited Warranty. CertainTeed's MAXIMUM LIABILITY during the first year of this warranty is the original cost of the CertainTeed membrane materials only. After the first year, CertainTeed's maximum liability is the original cost of the CertainTeed materials used on the roof reduced by 8.3% for 12-year warranty and 10% for 10-year warranty during each subsequent year, less any costs previously incurred by CertainTeed for repair or replacements.

Roof components which are not part of the roof membrane and hence not covered by this Limited Warranty include, but are not limited to, the following: underlying roof deck, insulation, vapor retarders, fasteners, metal work, drains, pitch pans, expansion joints, skylights, vents, plastic accessories, any flashing, decorative or reflective coating, surfacing and/or any aggregates. In no event, however, will CertainTeed be responsible for any costs related to the removal or abatement of any asbestos present in any existing roof system to which the CertainTeed roof membrane is applied.

What the Customer Must Do

If you believe your shingles have a manufacturing defect, you must notify CertainTeed within 30 days of discovery and provide proof of property ownership and the date of shingle purchase and application. Without original or sufficient proof of purchase CertainTeed reserves the right to use the shingle manufacturing date for claim calculation. In order to properly evaluate and process a warranty claim, CertainTeed may require the property owner to submit a shingle sample to CertainTeed for analysis and/or permit a CertainTeed representative to make repairs to, take photographs of, and/or take samples from the roof, if required. CertainTeed will evaluate each properly reported claim and will repair, replace, clean or reimburse the property owner for the shingles it determines are defective, in accordance with the terms of this Limited Warranty within a reasonable amount of time. For more details about submitting a warranty claim, visit www.ctroof.com or call (800) 345-1145.

Please send all notifications and correspondence to:

CertainTeed Corporation, 1508 Delp Drive, Harleysville, PA 19438.

Attn: CertainTeed Roofing Technical Services Department. Telephone number: 800-345-1145.

Warranty Registration (not required)

You may register your product warranty on CertainTeed's website:

www.certainteed.com/warrantyreg. Each registrant receives a registration confirmation number by return e-mail that can be printed and kept with this Limited Warranty and your proof of purchase. If you do not have internet access, you can register your shingles by sending: (1) your name, address, and telephone number; (2) the name and contact information of the contractor who installed your shingles and the original date of installation; and, (3) the type, color and number of squares of your shingles to: **CertainTeed Corporation, 20 Moores Road, Malvern, PA 19355, Attn: CertainTeed Roofing Technical Services Department.**

CertainTeed will register your information and mail you a confirmation number.

Failure to register this warranty does NOT void the warranty or any of its terms.

For Your Records

Product Purchased: _____ Date of Installation: _____

Roofing Contractor: _____ Contractor's Telephone No. _____

This warranty applies to shingles installed during the calendar year of 2019.

(The warranty in effect at the time the material is originally installed is the applicable warranty.)

Exclusive Warranty and Limitation of Remedies

THIS DOCUMENT CONSTITUTES THE EXCLUSIVE WARRANTIES AND REMEDIES PROVIDED BY CERTAINTEED. THE WARRANTIES AND REMEDIES CONTAINED IN THIS DOCUMENT ARE EXPRESSLY IN LIEU OF ANY AND ALL OTHER OBLIGATIONS, GUARANTEES, WARRANTIES AND REPRESENTATIONS, WHETHER WRITTEN, ORAL OR IMPLIED BY STATUTE, AT LAW OR IN EQUITY, INCLUDING WITHOUT LIMITATION, THE IMPLIED WARRANTIES OF MERCHANTABILITY AND FITNESS FOR A PARTICULAR PURPOSE. SOME STATES OR PROVINCES MAY NOT ALLOW THE EXCLUSION OF IMPLIED WARRANTIES OR MAY DETERMINE THE PERIOD OF TIME FOLLOWING THE SALE THAT A PURCHASER MAY SEEK A REMEDY UNDER IMPLIED WARRANTIES, SO THE ABOVE EXCLUSION MAY NOT APPLY TO YOU.

CERTAINTEED'S OBLIGATIONS, RESPONSIBILITIES, AND LIABILITY SHALL BE LIMITED TO REPAIRING OR REPLACING THE DEFECTIVE PRODUCT OR CLEANING ALGAE-RESISTANT SHINGLES IN THE CASE OF ALGAE GROWTH AS SET FORTH IN THIS LIMITED WARRANTY. IN NO EVENT SHALL CERTAINTEED BE LIABLE FOR ANY SPECIAL, INDIRECT, INCIDENTAL OR CONSEQUENTIAL DAMAGES OF ANY KIND, INCLUDING ANY DAMAGE TO THE PROPERTY, THE BUILDING OR ITS CONTENTS, OR FOR INJURY TO ANY PERSONS, THAT MAY OCCUR AS A RESULT OF THE USE OF CERTAINTEED'S PRODUCTS OR AS A RESULT OF THE BREACH OF THIS WARRANTY. IF YOUR STATE OR PROVINCE DOES NOT ALLOW EXCLUSIONS OR LIMITATIONS OF SPECIAL, INDIRECT, INCIDENTAL OR CONSEQUENTIAL DAMAGES, THE ABOVE LIMITATIONS MAY NOT APPLY TO YOU.

IN NO EVENT SHALL CERTAINTEED'S TOTAL LIABILITY ARISING OUT OF OR RELATED TO THE PRODUCT(S) OR THIS LIMITED WARRANTY EXCEED THE REASONABLE COST OF SHINGLES AND LABOR TO REPLACE OR REPAIR THE DEFECTIVE SHINGLES.

This Limited Warranty may not be modified, altered or expanded by anyone, including product distributors, dealers, sellers and/or CertainTeed field representatives.

This Limited Warranty gives you specific legal rights, and you may also have other rights which vary from State to State, or Province to Province.

Roofing Plants and Regional Sales Office

CertainTeed roofing products are sold by CertainTeed Roofing in nine sales regions. They are manufactured in ten residential roofing plants and one commercial roofing plant. Since the early 1900s, CertainTeed has been an innovator in the building materials industry and today is a leading manufacturer of building materials including residential and commercial roofing, vinyl siding, composite decking and railing, fiber glass insulation and vinyl fence products. The company is headquartered in Malvern, Pennsylvania, and employs more than 7,000 employees at approximately 60 manufacturing facilities throughout North America. Continuing the 100-year commitment of "Quality made certain, Satisfaction guaranteed™," CertainTeed remains one of the most trusted names in the industry. More information is available at www.certainteed.com.

This document is also available in Spanish and French.

Call 1-800-782-8777 or go to www.certainteed.com.

Se puede obtener este documento en español. Favor de llamar 1-800-782-8777.

Ce document est disponible en anglais et en espagnol. Composez le 1-800-782-8777.

ASPHALT SHINGLE PRODUCTS

2020 Limited Warranty



CertainTeed

ROOFING • SIDING • TRIM • DECKING • RAILING • FENCE • GYPSUM • CEILINGS • INSULATION

20 Moores Road Malvern, PA 19355

Professional: 800-233-8990 Consumer: 800-782-8777 certainteed.com



Congratulations... and thank you for your recent purchase of one of the fine products from CertainTeed Roofing. Since 1904, CertainTeed has been producing quality roofing products that provide long-lasting beauty and protection for homes of every size, style and age. For over 100 years, the basis for our name, "Quality made certain, satisfaction guaranteed," has been our ongoing philosophy.

Your CertainTeed roofing warranty fully explains how CertainTeed supports its products with the strongest warranty protection available. It is important that you read the warranty section of this brochure. The warranty lists the specific CertainTeed asphalt shingle products that are covered and the period of time for which they are covered. Take the time to understand how CertainTeed protects your purchase by standing behind our products.

Limited, Prorated and Transferable Warranty

This warranty covers asphalt shingle products listed in Table 1, sold only in the United States of America, its territories and Canada.

What and Who Are Covered and for How Long

From the date of installation, CertainTeed warrants to the original property owner/consumer that, when subject to normal and proper use, its shingles will be free from manufacturing defects for the warranty period specified in Table 1. CertainTeed will pay to repair, replace or clean, at its option, any shingles CertainTeed determines are defective under the terms of this Limited Warranty. In the event of repair, replacement or cleaning pursuant to the terms of this Limited Warranty, the warranty applicable to the original shingles shall apply to the repaired, replaced or cleaned shingles and will extend for the balance of the original warranty period.

Lifetime means for as long as the original individual property owner owns the property where the shingles are installed.

The Lifetime warranty period offered for certain shingles in Table 1 is only available to individual property owners. The warranty period for shingles installed on premises not used by individual property owners as their residence is limited as specified in Table 1. All property owners, who are not individual property owners, and all structures not used by individual property owners as their residence (e.g. corporations, governmental agencies, partnerships, religious organizations, schools, condominiums, property owner associations or cooperative housing arrangements, apartment buildings, and any other type of building or premises not owned by individual property owners) called "Other Ownership" are limited to either a 50-year or 40-year warranty period described in Table 1. In addition, for Other Ownership after the SureStart™ Protection period ends, this Limited Warranty covers only manufacturing defects that caused water penetration.

SureStart™ Protection

Because CertainTeed roofing products are manufactured to the highest quality standards, we confidently include the additional assurance of SureStart™ protection. SureStart provides the strongest non-prorated protection you can get in the vital early years of your new roof.

All of CertainTeed's shingle products are covered by SureStart protection. Under this warranty feature, CertainTeed, at no charge, will pay to repair or replace, at its option, any shingles CertainTeed determines are defective during the SureStart period. Note: Wind warranty and algae warranty are covered separately as described on page 5. The SureStart period begins on the date of application and terminates following the warranty period specified in Table 1. CertainTeed's maximum liability under SureStart is equal to the reasonable cost of comparable replacement shingles and labor as determined by CertainTeed to replace or repair the defective shingles. Roof tear-off, metal work, flashing and disposal expenses, and other costs or expenses incurred during such repair or replacement are not covered or reimbursed by this Limited Warranty, except for certain products with Lifetime warranty periods specified in Table 1, for which CertainTeed's maximum liability also includes the cost of roof tear-off, metal work, flashing and disposal.

In instances in which CertainTeed, under the terms of this warranty, has agreed to pay the reasonable cost of labor required to repair or replace defective shingles, CertainTeed will determine labor costs by Bluebook® or RS Means® data. CertainTeed will provide reimbursement for labor only upon receipt of a copy of the contractor's invoice or other written evidence of the completion of such work which CertainTeed, in its sole discretion, deems acceptable.

Costs associated with removal or replacement of overburden (items installed over the shingles, including but not limited to, solar panels, satellite dishes and gardens) are the sole responsibility of the property owner.

SureStart protection does not extend to any shingles applied to non-ventilated or inadequately ventilated roof deck systems as determined by CertainTeed, except as stated on page 4. CertainTeed's maximum contribution toward the cost of repairing or replacing defective shingles applied to a non-ventilated or inadequately ventilated roof deck system is calculated using the reasonable cost of comparable replacement shingles as determined by CertainTeed less 1/120th of that amount multiplied by the number of months from the start of the warranty period to the date when CertainTeed determines the shingles are defective. Labor costs, roof tear-off, metal work, flashing and disposal expenses, and other costs or expenses incurred during such repair or replacement are not covered or reimbursed by this Limited Warranty.

Beyond SureStart™ Protection

After the SureStart Protection period, if CertainTeed determines its shingles have a manufacturing defect, or for Other Ownership, if CertainTeed determines its shingles have a manufacturing defect that caused water penetration, CertainTeed's maximum contribution toward the cost of repairing or replacing defective shingles will be calculated using the reasonable cost of comparable replacement shingles as determined by CertainTeed less the Reduction Figure Per Month, specified in Table 1, for the number of months from the start of the warranty period to the date when CertainTeed determines the shingles are defective. Labor costs, roof tear-off, metal work, flashing and disposal expenses, and other costs or expenses incurred during such repair or replacement are not covered or reimbursed by this Limited Warranty.

TABLE 1

	Warranty Period	SureStart Period	Wind Warranty Miles Per Hour	Algae Resistant Warranty Period ¹	Reduction Figure Per Month
Lifetime Products^A					
Grand Manor® Presidential Shake® TL Presidential Solaris® Landmark® TL Presidential Shake® (& IR) ² Carriage House® Belmont® (& IR) ² Landmark® Premium Landmark Solaris® Landmark® PRO NorthGate® Highland Slate®	Lifetime ^a	10 Years	110 ^{tt}	15	1/600*
Lifetime Products^B					
Landmark® IR ² Landmark®	Lifetime ^a Lifetime ^a	10 Years 10 Years	110 ^{tt} 110 ^{tt}	10 10	1/600* 1/600*
20 -, 25 - and 30 - Year Products	Warranty Period	SureStart Period	Wind Warranty Miles Per Hour	Algae Resistant Warranty Period ¹	Reduction Figure Per Month
Patriot XT™30 IR ² XT™25 ³ CT™20	30 Years 30 Years 25 Years 20 Years	8 Years 5 Years 5 Years 3 Years	110 70 60 60	10 10 10	1/360 1/360 1/300 1/240
Any shingles applied to any inadequately ventilated roof deck <i>(see footnotes to Table 1 on the next page)</i>	10 years ^t	N/A	N/A	N/A	1/120

FOOTNOTES TO TABLE 1.

A. The Lifetime Warranty period is only available to individual property owners on premises used as their residence. The warranty period for Other Ownership for these shingles is limited to 50 years and the SureStart period is 10 years following the installation of the shingles. **Roof tear-off, metal work, flashing and disposal expense, incurred during repair or replacement are covered or reimbursed by this Limited Warranty.** Limited Warranty transferees during the SureStart™ period are limited to a 50-year warranty period (see section titled "Transfers During the SureStart Period" for details).

B. The Lifetime Warranty period is only available to individual property owners on premises used as their residence. The warranty period for Other Ownership for these shingles is limited to 40 years and the SureStart period is 5 years following the installation of the shingles. Limited Warranty transferees during the SureStart period are limited to a 40-year warranty period (see section titled "Transfers During the SureStart Period" for details).

* For Lifetime products, at the completion of the 40th year the reduction figure will remain at 480/600, or 20% of the total maximum liability.

† For details of warranty coverage for shingles installed on inadequately ventilated roof decks on both residential and commercial buildings, see provisions under "Inadequately Ventilated and Non-Ventilated Decks."

†† Wind warranty upgrade – These products are warranted to resist blow-off due to wind velocities, including gusts, up to a maximum of 130 miles per hour during the first fifteen (15) years, provided all of the following conditions are met:

1. The CertainTeed shingles are not applied over existing roof shingles (roof-overs are not permitted).
2. The CertainTeed specified corresponding hip and ridge accessory products are installed as cap shingles [Shadow Ridge®, Cedar Crest®, Shangle Ridge®, Mountain Ridge® and Landmark Solaris® (& IR)].
3. The CertainTeed specified corresponding starter shingles are installed along the roof eaves and rakes (Swiftstart®, High-Performance Starter and Presidential® Starter).

(Note: In Florida, CertainTeed will waive the requirement of applying starter shingles along the roof rake if all of the following conditions are met: The applicable building code requires that asphalt roof shingles be embedded in an 8-inch-wide bed of asphalt roofing cement applied along the roof rake edges. And, the shingles are installed and embedded in an 8-inch-wide bed of asphalt roofing cement along the roof rake edges in accordance with the code.)

¹Algae Resistant Warranty period applies only to the Algae Resistant (AR) version of the pertinent shingle.

²CertainTeed's Impact Resistant (IR) versions of Landmark®, Presidential Shake®, Belmont®, and XT™ 30 shingles comply with UL 2218 Impact Resistance of Prepared Roof Covering Materials test criteria at time of manufacture.

³The wind warranty for XT™ 25 shingles installed in Alaska is 90 mph.

Transferability

This Limited Warranty is transferable, but only by the original property owner/consumer to the first subsequent property owner. After the Limited Warranty has been transferred once, it is no longer transferable. A bank foreclosure or a change of ownership on a deed is deemed a transfer under this Limited Warranty.

Transfers During the SureStart™ Period

If this Limited Warranty is transferred during the product's SureStart period, the warranty for the new owner is the same as it would have been for the original owner, except for certain products with Lifetime warranty periods where the duration of the transferred warranty will be 50 years or 40 years as specified in Table 1, measured from the beginning of the SureStart period (i.e. the date of installation), and the remaining period of SureStart protection will be available to the subsequent property owner.

Transfers After the SureStart Period

If this Limited Warranty is transferred by the original property owner/consumer after the SureStart period, the warranty following the transfer will be limited to two (2) years from the date of the transfer. The warranty obligation will be calculated as explained in the section titled "Beyond SureStart Protection."

Limitations

This Limited Warranty does not provide protection against, and CertainTeed will have no liability for, any failure, defect or damage as a result of, including but not limited to:

- Winds, including gusts, greater than the Wind Warranty MPH in Table 1
- Damage caused by lightning, hailstorm, earthquake, fire, explosion, flood or falling objects.
- Damage caused by tornado, or hurricanes (other than as warranted under Wind Warranty MPH in Table 1).
- Distortion, cracking or other failure or movement of: the base material over which the shingles are applied, the roof deck, or the walls or foundation of the building itself.
- Damage caused by structural changes, alterations or additions, or by the installation of equipment (such as, but not limited to, aerials, signs or air-conditioning equipment) to the building after the original shingles have been applied.

- Shading, stains or discoloration to the shingles arising from outside sources such as, but not limited to, algae (unless blue-green algae as described in the section titled "Limited Algae Resistant Warranty"), fungus, moss, lichens or other vegetation, mold or mildew growth, or paints, chemicals or other similar materials.
- Misuse, abuse, neglect, or improper transportation, handling or storage of the shingles.
- Installation of the shingles over non-approved roof decks as more fully explained in CertainTeed's installation instructions published at the time of original installation.
- Damage caused by improper installation or installation not in accordance with CertainTeed's installation instructions published at the time of original installation.
- Damage to the shingles, the roof deck or the structure caused by ice backup or ice damming.
- Damage caused by impact, including such things as tools, equipment or foot traffic.
- Vandalism or acts of war.
- Animals, animal feces or insects.
- Any other cause not a result of a manufacturing defect in the shingles.

Mold and mildew are functions of environmental conditions and are not manufacturing defects. As such, mold and mildew are not covered by this Limited Warranty or any implied warranty.

CertainTeed reserves the right to discontinue or modify any of its products, including the color of its shingles, and shall not be liable as a result of such discontinuance or modification, nor shall CertainTeed be liable in the event replacement material varies in color in comparison to the original product as a result of normal weathering. If CertainTeed replaces any material under this warranty, it may substitute products designated by CertainTeed to be of comparable quality or price range in the event the product initially installed has been discontinued or modified.

Inadequately Ventilated and Non-Ventilated Decks

Any shingles applied to inadequately ventilated or non-ventilated decks, other than the shingles and deck systems described in the section titled "Insulated Decks and Radiant Barriers," are subject to a reduced limited warranty period of ten (10) years and do not qualify for SureStart Protection. **SureStart™ Protection and the Warranty Period applicable to the shingle are available if** CertainTeed determines that the shingle damage was caused exclusively by a manufacturing defect that is unrelated to the inadequate roof system ventilation.

Insulated Decks and Radiant Barriers

CertainTeed's Limited Warranty, including SureStart Protection, will remain in force when its fiberglass shingles are applied to roof deck assemblies where foam insulation is prefabricated into the roof deck system (often called "naillboard insulation"), where insulation is installed beneath an acceptable roof deck system, or where radiant barriers are installed, with or without ventilation, directly below the deck. Acceptable roof deck surfaces must consist of at least 3/8" thick plywood or 7/16" thick Oriented Strand Board (OSB) and slopes must be 2:12 or greater. If a different deck surface material will be utilized, please contact CertainTeed's Technical Services Department for assistance. (See the following important restrictions.)

The design professional is responsible for ensuring: 1) the proper quality and application of the insulation and/or radiant barrier, 2) the provision of adequate structural ventilation and/or vapor retarders as determined to be necessary, and 3) that all local codes are met (particularly taking into account local climate conditions). Special attention must be taken if cellular foam, fiberglass, cellulose insulation or other highly permeable insulation will be used in an unventilated system, or if the insulation/rafter or insulation/joist planes may create an air leak that could lead to moisture transmission and condensation problems. All these important factors and decisions, while not the responsibility of CertainTeed, are critical to assure proper deck system performance.

Ventilated Nail-Base Roof Insulation

Ventilated Nail-Base Roof Insulation products (e.g. FlintBoard® CV) are made of rigid insulation (typically foam board) and another layer of material that provides air space above the insulation and below the nailable deck (which is typically at least 7/16" thick OSB or 3/8" thick plywood). These products can provide soffit-to-ridge ventilation, and if installed in accordance with the deck manufacturer's instructions to achieve sufficient ventilation, will not reduce the scope or length of CertainTeed's Limited Warranty coverage.

Limited Algae-Resistant Warranty

Blue-green algae or gloeocapsa magma, (which has a black/brown appearance and is commonly but incorrectly called "fungus"), can create unsightly streaking on shingles. CertainTeed warrants that the Algae-Resistant (AR) versions of the products in Table 1 will remain free from blue-green algae growth (but not mold or mildew growth) which adversely affects the overall appearance of said shingles for a period of ten (10) or fifteen (15) years, as noted in Table 1.

If during the Algae-Resistant Warranty Period specified in Table 1, the overall appearance of the Algae-Resistant shingles is adversely affected by blue-green algae, CertainTeed will pay the reasonable cost to replace or clean at its option, any affected shingles. In the event of replacement or cleaning, for the remainder of the Algae-Resistant Warranty Period, CertainTeed's maximum contribution towards subsequent replacement or cleaning will be calculated using the Algae-Resistant Warranty Period specified in Table 1, less a prorated adjustment that reflects the number of months that have elapsed from the start of the Algae-Resistant Warranty Period to the date of reoccurrence.

WARNING: FOR LOW-VOLUME RAIN AND SALT FOG AREAS

In areas of low-volume rain (e.g. areas that receive insignificant rainfall during a 90-day period) and/or "salt fog" (e.g. parts of the Southern California coastline), copper released by algae-resistant (AR) granules or shingles can react with aluminum in gutters and cause severe corrosion of the gutters. In such regions, CertainTeed strongly recommends that vinyl or copper gutters, not aluminum gutters, be used with algae-resistant shingles. CertainTeed disclaims all liability and responsibility for any damages that may result from the use of its algae-resistant shingle products with copper granules where gutters containing aluminum are used.

Limited Wind Warranty

CertainTeed warrants its shingles will resist blow-off damage due to wind velocities, including gusts, up to the maximum wind velocity per the Wind Warranty MPH specified in Table 1 during the first fifteen (15) years of the warranty for Lifetime products and during the first ten (10) years for Patriot shingles and during the first five (5) years for all other products listed in Table 1.

CertainTeed's obligations and liability for shingle blow-off damage during the wind warranty periods as specified above are limited as follows:

- If shingles or hip/ridge accessories blow off because the self-sealing asphalt strips did not activate, CertainTeed will furnish replacement shingles without charge, but only for damaged or blown off shingles.
- If shingles or hip/ridge accessories blow off before the self-sealing asphalt strips could have reasonably activated due to installation in cold weather, CertainTeed will furnish replacement shingles without charge, but only for damaged or blown off shingles. CertainTeed will not be responsible for or reimburse labor costs, roof tear-off, metal work, flashing and disposal expenses, or any other costs pertaining to removal or replacement of damaged shingles. Any costs in excess of CertainTeed's material contribution are the property owner's responsibility (and may be covered by owner's insurance).
- CertainTeed shall have no liability for any shingles not fastened in accordance with CertainTeed installation instructions published at the time of original installation.
- CertainTeed shall have no liability for any damage to persons or property caused by blown off shingles.
- CertainTeed's maximum liability during the Limited Wind Warranty period is the reasonable cost of hand sealing all of the shingles on the roof.

Flintlastic® SA (Self-Adhering) System

For low slope residential roofing projects less than 2000 square feet (20 squares), CertainTeed offers a roof membrane limited warranty as follows: A 10-year warranty duration on a single ply of Flintlastic SA Cap sheet over a primed plywood roof deck or a 12-year warranty duration for a two-ply system consisting of a Flintlastic SA NailBase and a Flintlastic SA Cap sheet, provided the Flintlastic products were applied in accordance with CertainTeed's current installation instructions published at the time of installation.

CertainTeed warrants the roof membrane, subject to the following terms, conditions, limitations, and exclusions, for the duration specified above from the date of completion of the roof membrane installation. If during the duration of this Limited Warranty, a manufacturing defect in the roof membrane causes a leak, CertainTeed or its designated roofing contractor will,

at CertainTeed's sole discretion, repair or replace the roof membrane materials only as necessary to restore it to a watertight condition.

Only manufacturing defects in the roof membrane that cause leaks are covered by this Limited Warranty. CertainTeed's MAXIMUM LIABILITY during the first year of this warranty is the original cost of the CertainTeed membrane materials only. After the first year, CertainTeed's maximum liability is the original cost of the CertainTeed materials used on the roof reduced by 8.3% for 12-year warranty and 10% for 10-year warranty during each subsequent year, less any costs previously incurred by CertainTeed for repair or replacements.

Roof components which are not part of the roof membrane and hence not covered by this Limited Warranty include, but are not limited to, the following: underlying roof deck, insulation, vapor retarders, fasteners, metal work, drains, pitch pans, expansion joints, skylights, vents, plastic accessories, any flashing, decorative or reflective coating, surfacing and/or any aggregates. In no event, however, will CertainTeed be responsible for any costs related to the removal or abatement of any asbestos present in any existing roof system to which the CertainTeed roof membrane is applied.

What the Customer Must Do

If you believe your shingles have a manufacturing defect, you must notify CertainTeed within 30 days of discovery and provide proof of property ownership and the date of shingle purchase and application. Without original or sufficient proof of purchase CertainTeed reserves the right to use the shingle manufacturing date for claim calculation. In order to properly evaluate and process a warranty claim, CertainTeed may require the property owner to submit a shingle sample to CertainTeed for analysis and/or permit a CertainTeed representative to make repairs to, take photographs of, and/or take samples from the roof, if required. CertainTeed will evaluate each properly reported claim and will repair, replace, clean or reimburse the property owner for the shingles it determines are defective, in accordance with the terms of this Limited Warranty within a reasonable amount of time. For more details about submitting a warranty claim, visit www.ctroof.com or call (800) 345-1145.

Please send all notifications and correspondence to:

CertainTeed LLC, 1508 Delp Drive, Harleysville, PA 19438.

Attn: CertainTeed Roofing Technical Services Department. Telephone number: 800-345-1145.

Warranty Registration (not required)

You may register your product warranty on CertainTeed's website:

www.certainteed.com/warrantyreg. Each registrant receives a registration confirmation number by return e-mail that can be printed and kept with this Limited Warranty and your proof of purchase. If you do not have internet access, you can register your shingles by sending: (1) your name, address, and telephone number; (2) the name and contact information of the contractor who installed your shingles and the original date of installation; and, (3) the type, color and number of squares of your shingles to: **CertainTeed LLC, 20 Moores Road, Malvern, PA 19355, Attn: CertainTeed Roofing Technical Services Department.**

CertainTeed will register your information and mail you a confirmation number.

Failure to register this warranty does NOT void the warranty or any of its terms.

For Your Records

Product Purchased: _____ Date of Installation: _____

Roofing Contractor: _____ Contractor's Telephone No. _____

This warranty applies to shingles installed during the calendar year of 2020.

(The warranty in effect at the time the material is originally installed is the applicable warranty.)

Exclusive Warranty and Limitation of Remedies

THIS DOCUMENT CONSTITUTES THE EXCLUSIVE WARRANTIES AND REMEDIES PROVIDED BY CERTAINTEED. THE WARRANTIES AND REMEDIES CONTAINED IN THIS DOCUMENT ARE EXPRESSLY IN LIEU OF ANY AND ALL OTHER OBLIGATIONS, GUARANTEES, WARRANTIES AND REPRESENTATIONS, WHETHER WRITTEN, ORAL OR IMPLIED BY STATUTE, AT LAW OR IN EQUITY, INCLUDING WITHOUT LIMITATION, THE IMPLIED WARRANTIES OF MERCHANTABILITY AND FITNESS FOR A PARTICULAR PURPOSE. SOME STATES OR PROVINCES MAY NOT ALLOW THE EXCLUSION OF IMPLIED WARRANTIES OR MAY DETERMINE THE PERIOD OF TIME FOLLOWING THE SALE THAT A PURCHASER MAY SEEK A REMEDY UNDER IMPLIED WARRANTIES, SO THE ABOVE EXCLUSION MAY NOT APPLY TO YOU.

ASPHALT SHINGLE PRODUCTS

2021 Limited Warranty



CertainTeed
SAINT-GOBAIN

Congratulations... and thank you for your recent purchase of one of the fine products from CertainTeed Roofing. Since 1904, CertainTeed has been producing quality roofing products that provide long-lasting beauty and protection for homes of every size, style and age. For over 100 years, the basis for our name, "Quality made certain, satisfaction guaranteed," has been our ongoing philosophy.

Your CertainTeed roofing warranty fully explains how CertainTeed supports its products with the strongest warranty protection available. It is important that you read the warranty section of this brochure. The warranty lists the specific CertainTeed asphalt shingle products that are covered and the period of time for which they are covered. Take the time to understand how CertainTeed protects your purchase by standing behind our products.

Limited, Prorated and Transferable Warranty

This warranty covers asphalt shingle products listed in Table 1, sold only in the United States of America, its territories and Canada.

What and Who Are Covered and for How Long

From the date of installation, CertainTeed warrants to the original property owner/consumer that, when subject to normal and proper use, its shingles will be free from manufacturing defects for the warranty period specified in Table 1. CertainTeed will pay to repair, replace or clean, at its option, any shingles CertainTeed determines are defective under the terms of this Limited Warranty. In the event of repair, replacement or cleaning pursuant to the terms of this Limited Warranty, the warranty applicable to the original shingles shall apply to the repaired, replaced or cleaned shingles and will extend for the balance of the original warranty period.

Lifetime means for as long as the original individual property owner owns the property where the shingles are installed.

The Lifetime warranty period offered for certain shingles in Table 1 is only available to individual property owners. The warranty period for shingles installed on premises not used by individual property owners as their residence is limited as specified in Table 1. All property owners, who are not individual property owners, and all structures not used by individual property owners as their residence (e.g. corporations, governmental agencies, partnerships, religious organizations, schools, condominiums, property owner associations or cooperative housing arrangements, apartment buildings, and any other type of building or premises not owned by individual property owners) called "Other Ownership" are limited to either a 50-year or 40-year warranty period described in Table 1. In addition, for Other Ownership after the SureStart™ Protection period ends, this Limited Warranty covers only manufacturing defects that caused water penetration.

SureStart™ Protection

Because CertainTeed roofing products are manufactured to the highest quality standards, we confidently include the additional assurance of SureStart™ protection. SureStart provides the strongest non-prorated protection you can get in the vital early years of your new roof.

All of CertainTeed's shingle products are covered by SureStart protection. Under this warranty feature, CertainTeed, at no charge, will pay to repair or replace, at its option, any shingles CertainTeed determines are defective during the SureStart period. Note: Wind warranty and algae warranty are covered separately as described on page 5. The SureStart period begins on the date of application and terminates following the warranty period specified in Table 1. CertainTeed's maximum liability under SureStart is equal to the reasonable cost of comparable replacement shingles and labor as determined by CertainTeed to replace or repair the defective shingles. Roof tear-off, metal work, flashing and disposal expenses, and other costs or expenses incurred during such repair or replacement are not covered or reimbursed by this Limited Warranty, except for certain products with Lifetime warranty periods specified in Table 1, for which CertainTeed's maximum liability also includes the cost of roof tear-off, metal work, flashing and disposal.

In instances in which CertainTeed, under the terms of this warranty, has agreed to pay the reasonable cost of labor required to repair or replace defective shingles, CertainTeed will determine labor costs by Bluebook® or RS Means® data. CertainTeed will provide reimbursement for labor only upon receipt of a copy of the contractor's invoice or other written evidence of the completion of such work which CertainTeed, in its sole discretion, deems acceptable.

Costs associated with removal or replacement of overburden (items installed over the shingles, including but not limited to, solar panels, satellite dishes and gardens) are the sole responsibility of the property owner.

SureStart protection does not extend to any shingles applied to non-ventilated or inadequately ventilated roof deck systems as determined by CertainTeed, except as stated on page 4. CertainTeed's maximum contribution toward the cost of repairing or replacing defective shingles applied to a non-ventilated or inadequately ventilated roof deck system is calculated using the reasonable cost of comparable replacement shingles as determined by CertainTeed less 1/120th of that amount multiplied by the number of months from the start of the warranty period to the date when CertainTeed determines the shingles are defective. Labor costs, roof tear-off, metal work, flashing and disposal expenses, and other costs or expenses incurred during such repair or replacement are not covered or reimbursed by this Limited Warranty.

Beyond SureStart™ Protection

After the SureStart Protection period, if CertainTeed determines its shingles have a manufacturing defect, or for Other Ownership, if CertainTeed determines its shingles have a manufacturing defect that caused water penetration, CertainTeed's maximum contribution toward the cost of repairing or replacing defective shingles will be calculated using the reasonable cost of comparable replacement shingles as determined by CertainTeed less the Reduction Figure Per Month, specified in Table 1, for the number of months from the start of the warranty period to the date when CertainTeed determines the shingles are defective. Labor costs, roof tear-off, metal work, flashing and disposal expenses, and other costs or expenses incurred during such repair or replacement are not covered or reimbursed by this Limited Warranty.

TABLE 1

<u>Lifetime Products^A</u>	<u>Warranty Period</u>	<u>SureStart Period</u>	<u>Wind Warranty Miles Per Hour</u>	<u>Algae Resistant Warranty Period¹</u>	<u>Reduction Figure Per Month</u>
Grand Manor® Presidential Shake® TL** Landmark® TL** Presidential Shake® (& IR) ^{2**} Carriage House® Belmont® (& IR) ² Landmark® Premium Landmark® PRO NorthGate® ClimateFlex® ² Highland Slate®	Lifetime ^A	10 Years	110 ^{**}	15	1/600*

<u>Lifetime Products^B</u>	<u>Warranty Period</u>	<u>SureStart Period</u>	<u>Wind Warranty Miles Per Hour</u>	<u>Algae Resistant Warranty Period¹</u>	<u>Reduction Figure Per Month</u>
Landmark® ClimateFlex® ²	Lifetime ^B	10 Years	110 ^{**}	10	1/600*
Landmark ^{***}	Lifetime ^B	10 Years	110 ^{**}	10	1/600*

<u>25 Year Product</u>	<u>Warranty Period</u>	<u>SureStart Period</u>	<u>Wind Warranty Miles Per Hour</u>	<u>Algae Resistant Warranty Period¹</u>	<u>Reduction Figure Per Month</u>
XT™ ²⁵	25 Years	5 Years	60	10	1/300
Any shingles applied to any inadequately ventilated roof deck	10 years [†]	N/A	N/A	N/A	1/120

** Including Solaris colors.
(see footnotes to Table 1)

FOOTNOTES TO TABLE 1.

A. The Lifetime Warranty period is only available to individual property owners on premises used as their residence. The warranty period for Other Ownership for these shingles is limited to 50 years and the SureStart period is 10 years following the installation of the shingles. **Roof tear-off, metal work, flashing and disposal expense, incurred during repair or replacement are covered or reimbursed by this Limited Warranty.** Limited Warranty transferees during the SureStart™ period are limited to a 50-year warranty period (see section titled "Transfers During the SureStart Period" for details).

B. The Lifetime Warranty period is only available to individual property owners on premises used as their residence. The warranty period for Other Ownership for these shingles is limited to 40 years and the SureStart period is 5 years following the installation of the shingles. Limited Warranty transferees during the SureStart period are limited to a 40-year warranty period (see section titled "Transfers During the SureStart Period" for details).

* For Lifetime products, at the completion of the 40th year the reduction figure will remain at 480/600, or 20% of the total maximum liability.

^f For details of warranty coverage for shingles installed on inadequately ventilated roof decks on both residential and commercial buildings, see provisions under "Inadequately Ventilated and Non-Ventilated Decks."

^{††} Wind warranty upgrade - These products are warranted to resist blow-off due to wind velocities, including gusts, up to a maximum of 130 miles per hour during the first fifteen (15) years, provided all of the following conditions are met:

1. The CertainTeed shingles are not applied over existing roof shingles (roof-overs are not permitted).
2. The CertainTeed specified corresponding hip and ridge accessory products are installed as cap shingles [Shadow Ridge®, Cedar Crest®, Shangle Ridge®, Mountain Ridge® and Landmark Solaris® (& IR)].
3. The CertainTeed specified corresponding starter shingles are installed along the roof eaves and rakes (Swiftstart®, High-Performance Starter and Presidential® Starter).

(Note: In Florida, CertainTeed will waive the requirement of applying starter shingles along the roof rake if all of the following conditions are met: The applicable building code requires that asphalt roof shingles be embedded in an 8-inch-wide bed of asphalt roofing cement applied along the roof rake edges. And, the shingles are installed and embedded in an 8-inch-wide bed of asphalt roofing cement along the roof rake edges in accordance with the code.)

¹Algae Resistant Warranty period applies only to the Algae Resistant (AR) version of the pertinent shingle.

²CertainTeed's Impact Resistant Landmark®, ClimateFlex®, NorthGate®, ClimateFlex®, Presidential Shake® IR, and Belmont® IR shingles comply with UL 2218 Impact Resistance of Prepared Roof Covering Materials test criteria at time of manufacture.

³The wind warranty for XT™25 shingles installed in Alaska is 90 mph.

Transferability

This Limited Warranty is transferable, but only by the original property owner/consumer to the first subsequent property owner. After the Limited Warranty has been transferred once, it is no longer transferable. A bank foreclosure or a change of ownership on a deed is deemed a transfer under this Limited Warranty.

Transfers During the SureStart™ Period

If this Limited Warranty is transferred during the product's SureStart period, the warranty for the new owner is the same as it would have been for the original owner, except for certain products with Lifetime warranty periods where the duration of the transferred warranty will be 50 years or 40 years as specified in Table 1, measured from the beginning of the SureStart period (i.e. the date of installation), and the remaining period of SureStart protection will be available to the subsequent property owner.

Transfers After the SureStart Period

If this Limited Warranty is transferred by the original property owner/consumer after the SureStart period, the warranty following the transfer will be limited to two (2) years from the date of the transfer. The warranty obligation will be calculated as explained in the section titled "Beyond SureStart Protection."

Limitations

This Limited Warranty does not provide protection against, and CertainTeed will have no liability for, any failure, defect or damage as a result of, including but not limited to:

- Winds, including gusts, greater than the Wind Warranty MPH in Table 1
- Damage caused by lightning, hailstorm, earthquake, fire, explosion, flood or falling objects.
- Damage caused by tornado, or hurricanes (other than as warranted under Wind Warranty MPH in Table 1).
- Distortion, cracking or other failure or movement of: the base material over which the shingles are applied, the roof deck, or the walls or foundation of the building itself.
- Damage caused by structural changes, alterations or additions, or by the installation of equipment (such as, but not limited to, aerials, signs or air-conditioning equipment) to the building after the original shingles have been applied.
- Shading, stains or discoloration to the shingles arising from outside sources such as, but not limited to, algae (unless blue-green algae as described in the section titled "Limited Algae Resistant Warranty"), fungus, moss, lichens or other vegetation, mold or mildew growth, or paints, chemicals or other similar materials.
- Misuse, abuse, neglect, or improper transportation, handling or storage of the shingles.
- Installation of the shingles over non-approved roof decks as more fully explained in CertainTeed's installation instructions published at the time of original installation.

- Damage caused by improper installation or installation not in accordance with CertainTeed's installation instructions published at the time of original installation.
- Damage to the shingles, the roof deck or the structure caused by ice backup or ice damming.
- Damage caused by impact, including such things as tools, equipment or foot traffic.
- Vandalism or acts of war.
- Animals, animal feces or insects.
- Any other cause not a result of a manufacturing defect in the shingles.

Mold and mildew are functions of environmental conditions and are not manufacturing defects. As such, mold and mildew are not covered by this Limited Warranty or any implied warranty.

CertainTeed reserves the right to discontinue or modify any of its products, including the color of its shingles, and shall not be liable as a result of such discontinuance or modification, nor shall CertainTeed be liable in the event replacement material varies in color in comparison to the original product as a result of normal weathering. If CertainTeed replaces any material under this warranty, it may substitute products designated by CertainTeed to be of comparable quality or price range in the event the product initially installed has been discontinued or modified.

Inadequately Ventilated and Non-Ventilated Decks

Any shingles applied to inadequately ventilated or non-ventilated decks, other than the shingles and deck systems described in the section titled "Insulated Decks and Radiant Barriers," are subject to a reduced limited warranty period of ten (10) years and do not qualify for SureStart Protection. SureStart™ Protection and the Warranty Period applicable to the shingle are available if CertainTeed determines that the shingle damage was caused exclusively by a manufacturing defect that is unrelated to the inadequate roof system ventilation.

Insulated Decks and Radiant Barriers

CertainTeed's Limited Warranty, including SureStart Protection, will remain in force when its fiberglass shingles are applied to roof deck assemblies where foam insulation is prefabricated into the roof deck system (often called "nailboard insulation"), where insulation is installed beneath an acceptable roof deck system, or where radiant barriers are installed, with or without ventilation, directly below the deck. Acceptable roof deck surfaces must consist of at least 3/8" thick plywood or 7/16" thick Oriented Strand Board (OSB) and slopes must be 2:12 or greater. If a different deck surface material will be utilized, please contact CertainTeed's Technical Services Department for assistance. (See the following important restrictions.)

The design professional is responsible for ensuring: 1) the proper quality and application of the insulation and/or radiant barrier, 2) the provision of adequate structural ventilation and/or vapor retarders as determined to be necessary, and 3) that all local codes are met (particularly taking into account local climate conditions). Special attention must be taken if cellular foam, fiberglass, cellulose insulation or other highly permeable insulation will be used in an unventilated system, or if the insulation/rafter or insulation/joist planes may create an air leak that could lead to moisture transmission and condensation problems. All these important factors and decisions, while not the responsibility of CertainTeed, are critical to assure proper deck system performance.

Ventilated Nail-Base Roof Insulation

Ventilated Nail-Base Roof Insulation products (e.g. FlintBoard® CV) are made of rigid insulation (typically foam board) and another layer of material that provides air space above the insulation and below the nailable deck (which is typically at least 7/16" thick OSB or 3/8" thick plywood). These products can provide soffit-to-ridge ventilation, and if installed in accordance with the deck manufacturer's instructions to achieve sufficient ventilation, will not reduce the scope or length of CertainTeed's Limited Warranty coverage.

Limited Algae-Resistant Warranty

Blue-green algae or gloeocapsa magma, (which has a black/brown appearance and is commonly but incorrectly called "fungus"), can create unsightly streaking on shingles. CertainTeed warrants that the Algae-Resistant (AR) versions of the products in Table 1 will remain free from blue-green algae growth (but not mold or mildew growth) which adversely affects the overall appearance of said shingles for a period of ten (10) or fifteen (15) years, as noted in Table 1.

If during the Algae-Resistant Warranty Period specified in Table 1, the overall appearance of the Algae-Resistant shingles is adversely affected by blue-green algae, CertainTeed will pay the reasonable cost to replace or clean at its option, any affected shingles. In the event of replacement or cleaning, for

the remainder of the Algae-Resistant Warranty Period, CertainTeed's maximum contribution towards subsequent replacement or cleaning will be calculated using the Algae-Resistant Warranty Period specified in Table 1, less a prorated adjustment that reflects the number of months that have elapsed from the start of the Algae-Resistant Warranty Period to the date of reoccurrence.

WARNING: FOR LOW-VOLUME RAIN AND SALT FOG AREAS

In areas of low-volume rain (e.g. areas that receive insignificant rainfall during a 90-day period) and/or "salt fog" (e.g. parts of the Southern California coastline), copper released by algae-resistant (AR) granules or shingles can react with aluminum in gutters and cause severe corrosion of the gutters. In such regions, CertainTeed strongly recommends that vinyl or copper gutters, not aluminum gutters, be used with algae-resistant shingles. CertainTeed disclaims all liability and responsibility for any damages that may result from the use of its algae-resistant shingle products with copper granules where gutters containing aluminum are used.

Limited Wind Warranty

CertainTeed warrants its shingles will resist blow-off damage due to wind velocities, including gusts, up to the maximum wind velocity per the Wind Warranty MPH specified in Table 1 during the first fifteen (15) years of the warranty for Lifetime products and during the first five (5) years for all other products listed in Table 1.

CertainTeed's obligations and liability for shingle blow-off damage during the wind warranty periods as specified above are limited as follows:

- If shingles or hip/ridge accessories blow off because the self-sealing asphalt strips did not activate, CertainTeed will furnish replacement shingles without charge, but only for damaged or blown off shingles.
- If shingles or hip/ridge accessories blow off before the self-sealing asphalt strips could have reasonably activated due to installation in cold weather, CertainTeed will furnish replacement shingles without charge, but only for damaged or blown off shingles. CertainTeed will not be responsible for or reimburse labor costs, roof tear-off, metal work, flashing and disposal expenses, or any other costs pertaining to removal or replacement of damaged shingles. Any costs in excess of CertainTeed's material contribution are the property owner's responsibility (and may be covered by owner's insurance).
- CertainTeed shall have no liability for any shingles not fastened in accordance with CertainTeed installation instructions published at the time of original installation.
- CertainTeed shall have no liability for any damage to persons or property caused by blown off shingles.
- CertainTeed's maximum liability during the Limited Wind Warranty period is the reasonable cost of hand sealing all of the shingles on the roof.

Flintlastic® Low-Slope SA (Self-Adhered) System

For low slope residential roofing projects less than 2000 square feet (20 squares), CertainTeed offers a roof membrane limited warranty provided the Flintlastic products were applied in accordance with CertainTeed's current installation instructions published at the time of installation as follows:

- A 10-year warranty duration on a single ply of Flintlastic SA Cap sheet over a primed plywood roof deck.
- A 12-year warranty duration for a two-ply system consisting of a Flintlastic SA NailBase and a Flintlastic SA Cap sheet*.
- A 15-year warranty duration for a three-ply system consisting of a Flintlastic SA NailBase and a Flintlastic SA PlyBase and a Flintlastic SA Cap sheet*.
- A 20-year warranty duration for a three-ply system consisting of a Flintlastic SA NailBase and a Flintlastic SA MidPly and a Flintlastic SA Cap sheet*.

CertainTeed warrants the roof membrane, subject to the following terms, conditions, limitations, and exclusions, for the duration specified above from the date of completion of the roof membrane installation. If during the duration of this Limited Warranty, a manufacturing defect in the roof membrane causes a leak, CertainTeed or its designated roofing contractor will, at CertainTeed's sole discretion, repair or replace the roof membrane materials only as necessary to restore it to a watertight condition.

**Direct adhesion to wood, without the inclusion of the Flintlastic SA NailBase is permitted; direct adhesion to wood is not permitted by code in Miami-Dade County (check your local building code); direct adhesion to wood plank decks constructed of resinous woods, such as pine, is prohibited.*

Only manufacturing defects in the roof membrane that cause leaks are covered by this Limited Warranty. CertainTeed's MAXIMUM LIABILITY during the first year of this warranty is the original cost of the CertainTeed membrane materials only. After the first year, CertainTeed's maximum liability is the original cost of the CertainTeed membrane materials used on the roof reduced by 8.3% for 12-year warranty, 10% for 10-year warranty, 6.6% for 15-year warranty and 5% for 20-year warranty during each subsequent year, less any costs previously incurred by CertainTeed for repair or replacements.

Roof components which are not part of the roof membrane and hence not covered by this Limited Warranty include, but are not limited to, the following: underlying roof deck, insulation, vapor retarders, fasteners, metal work, drains, pitch pans, expansion joints, skylights, vents, plastic accessories, any flashing, decorative or reflective coating, surfacing and/or any aggregates. In no event, however, will CertainTeed be responsible for any costs related to the removal or abatement of any asbestos present in any existing roof system to which the CertainTeed roof membrane is applied.

What the Customer Must Do

If you believe your shingles have a manufacturing defect, you must notify CertainTeed within 30 days of discovery and provide proof of property ownership and the date of shingle purchase and application. Without original or sufficient proof of purchase CertainTeed reserves the right to use the shingle manufacturing date for claim calculation. In order to properly evaluate and process a warranty claim, CertainTeed may require the property owner to submit a shingle sample to CertainTeed for analysis and/or permit a CertainTeed representative to make repairs to, take photographs of, and/or take samples from the roof, if required. CertainTeed will evaluate each properly reported claim and will repair, replace, clean or reimburse the property owner for the shingles it determines are defective, in accordance with the terms of this Limited Warranty within a reasonable amount of time. For more details about submitting a warranty claim, visit ctroof.com or call (800) 345-1145.

Please send all notifications and correspondence to:

CertainTeed LLC, 200 Commerce Drive P.O. Box 1000 Montgomeryville, PA 18936.

Attn: CertainTeed Roofing Technical Services Department. Telephone number: 800-345-1145.

Email: rpg.t.services@saint-gobain.com

Warranty Registration (not required)

You may register your product warranty on CertainTeed's website: certainteed.com/warrantyreg. Each registrant receives a registration confirmation number by return e-mail that can be printed and kept with this Limited Warranty and your proof of purchase. If you do not have internet access, you can register your shingles by sending: (1) your name, address, and telephone number; (2) the name and contact information of the contractor who installed your shingles and the original date of installation; and, (3) the type, color and number of squares of your shingles to: **CertainTeed LLC, 20 Moores Road, Malvern, PA 19355, Attn: CertainTeed Roofing Technical Services Department.**

CertainTeed will register your information and mail you a confirmation number. Failure to register this warranty does NOT void the warranty or any of its terms.

For Your Records

Product Purchased: _____ Date of Installation: _____

Roofing Contractor: _____ Contractor's Telephone No. _____

This warranty applies to shingles installed during the calendar year of 2021.

(The warranty in effect at the time the material is originally installed is the applicable warranty.)

Exclusive Warranty and Limitation of Remedies

THIS DOCUMENT CONSTITUTES THE EXCLUSIVE WARRANTIES AND REMEDIES PROVIDED BY CERTAINTEED. THE WARRANTIES AND REMEDIES CONTAINED IN THIS DOCUMENT ARE EXPRESSLY IN LIEU OF ANY AND ALL OTHER OBLIGATIONS, GUARANTEES, WARRANTIES AND REPRESENTATIONS, WHETHER WRITTEN, ORAL OR IMPLIED BY STATUTE, AT LAW OR IN EQUITY, INCLUDING WITHOUT LIMITATION, THE IMPLIED WARRANTIES OF MERCHANTABILITY AND FITNESS FOR A PARTICULAR PURPOSE. SOME STATES OR PROVINCES MAY NOT ALLOW THE EXCLUSION OF IMPLIED WARRANTIES OR MAY DETERMINE THE PERIOD OF TIME FOLLOWING THE SALE THAT A PURCHASER MAY SEEK A REMEDY UNDER IMPLIED WARRANTIES, SO THE ABOVE EXCLUSION MAY NOT APPLY TO YOU.

CERTAINTEED'S OBLIGATIONS, RESPONSIBILITIES, AND LIABILITY SHALL BE LIMITED TO REPAIRING OR REPLACING THE DEFECTIVE PRODUCT OR CLEANING ALGAE-RESISTANT SHINGLES IN THE CASE OF ALGAE GROWTH AS SET FORTH IN THIS LIMITED WARRANTY. IN NO EVENT SHALL CERTAINTEED BE LIABLE FOR ANY SPECIAL, INDIRECT, INCIDENTAL OR CONSEQUENTIAL DAMAGES OF ANY KIND, INCLUDING ANY DAMAGE TO THE PROPERTY, THE BUILDING OR ITS CONTENTS, OR FOR INJURY TO ANY PERSONS, THAT MAY OCCUR AS A RESULT OF THE USE OF CERTAINTEED'S PRODUCTS OR AS A RESULT OF THE BREACH OF THIS WARRANTY. IF YOUR STATE OR PROVINCE DOES NOT ALLOW EXCLUSIONS OR LIMITATIONS OF SPECIAL, INDIRECT, INCIDENTAL OR CONSEQUENTIAL DAMAGES, THE ABOVE LIMITATIONS MAY NOT APPLY TO YOU. IN NO EVENT SHALL CERTAINTEED'S TOTAL LIABILITY ARISING OUT OF OR RELATED TO THE PRODUCT(S) OR THIS LIMITED WARRANTY EXCEED THE REASONABLE COST OF SHINGLES AND LABOR TO REPLACE OR REPAIR THE DEFECTIVE SHINGLES.

This Limited Warranty may not be modified, altered or expanded by anyone, including product distributors, dealers, sellers and/or CertainTeed field representatives.

This Limited Warranty gives you specific legal rights, and you may also have other rights which vary from State to State, or Province to Province.

Roofing Plants and Regional Sales Office

CertainTeed roofing products are sold by CertainTeed Roofing in nine sales regions. They are manufactured in ten residential roofing plants and one commercial roofing plant. Since the early 1900s, CertainTeed has been an innovator in the building materials industry and today is a leading manufacturer of building materials including residential and commercial roofing, vinyl siding, composite decking and railing, fiber glass insulation and vinyl fence products. The company is headquartered in Malvern, Pennsylvania, and employs more than 7,000 employees at approximately 60 manufacturing facilities throughout North America. Continuing the 100-year commitment of "Quality made certain, Satisfaction guaranteed™," CertainTeed remains one of the most trusted names in the industry. More information is available at certainteed.com.

This document is also available in Spanish and French.

Call 1-800-782-8777 or go to www.certainteed.com.

Se puede obtener este documento en español. Favor de llamar 1-800-782-8777.

Ce document est disponible en anglais et en espagnol. Composez le 1-800-782-8777.



CertainTeed

CEILING • DECKING • FENCE • GYPSUM • INSULATION • RAILING • ROOFING • SIDING • TRIM

20 Moores Road Malvern, PA 19355 Professional: 800-233-8990 Consumer: 800-782-8777 certainteed.com

Asphalt Shingle Residential Products

2023 Limited Warranty



Congratulations and thank you for your recent purchase of one of the fine products from CertainTeed Roofing! Since 1904, CertainTeed has been producing quality roofing products that provide long-lasting beauty and protection for homes of every size, style and age. For over 100 years, the basis for our name, "Quality made certain, satisfaction guaranteed," has been our ongoing philosophy.

Your CertainTeed roofing warranty fully explains how CertainTeed supports its products with the strongest warranty protection available. It is important that you read the warranty section of this brochure. The warranty lists the specific CertainTeed asphalt shingle products that are covered and the period of time for which they are covered. Take the time to understand how CertainTeed protects your purchase by standing behind our products.

Limited, Prorated and Transferable Warranty

This warranty covers asphalt shingle products listed in Table 1, sold only in the United States of America, its territories and Canada.

What and Who Are Covered and for How Long

From the date of installation, CertainTeed warrants to the original property owner/consumer that, when subject to normal and proper use, its shingles will be free from manufacturing defects for the warranty period specified in Table 1. CertainTeed will pay to repair, replace or clean, at its option, any shingles CertainTeed determines are defective under the terms of this Limited Warranty. In the event of repair, replacement or cleaning pursuant to the terms of this Limited Warranty, the warranty applicable to the original shingles shall apply to the repaired, replaced or cleaned shingles and will extend for the balance of the original warranty period.

Lifetime means for as long as the original individual property owner owns the property where the shingles are installed.

The Lifetime warranty period offered for certain shingles in Table 1 is only available to individual property owners. The warranty period for shingles installed on premises not used by individual property owners as their residence is limited as specified in Table 1. All property owners, who are not individual property owners, and all structures not used by individual property owners as their residence (e.g. corporations, governmental agencies, partnerships, religious organizations, schools, condominiums, property owner associations or cooperative housing arrangements, apartment buildings, and any other type of building or premises not owned by individual property owners) called "Other Ownership" are limited to either a 50-year or 40-year warranty period described in Table 1. In addition, for Other Ownership after the SureStart™ Protection period ends, this Limited Warranty covers only manufacturing defects that caused water penetration.

SureStart™ Protection

Because CertainTeed roofing products are manufactured to the highest quality standards, we confidently include the additional assurance of SureStart™ protection. SureStart provides the strongest non-prorated protection you can get in the vital early years of your new roof.

All of CertainTeed's shingle products are covered by SureStart protection. Under this warranty feature, CertainTeed, at no charge, will pay to repair or replace, at its option, any shingles CertainTeed determines are defective during the SureStart period. Note: Wind warranty and algae warranty are covered separately as described on page 5. The SureStart period begins on the date of application and terminates following the warranty period specified in Table 1. CertainTeed's maximum liability under SureStart is equal to the reasonable cost of comparable replacement shingles and labor as determined by CertainTeed to replace or repair the defective shingles. Roof tear-off, metal work, flashing and disposal expenses, and other costs or expenses incurred during such repair or replacement are not covered or reimbursed by this Limited Warranty, except for certain products with Lifetime warranty periods specified in Table 1, for which CertainTeed's maximum liability also includes the cost of roof tear-off, metal work, flashing and disposal.

In instances in which CertainTeed, under the terms of this warranty, has agreed to pay the reasonable cost of labor required to repair or replace defective shingles, CertainTeed will determine labor costs by Bluebook® or RS Means® data. CertainTeed will provide reimbursement for labor only upon receipt of a copy of the contractor's invoice or other written evidence of the completion of such work which CertainTeed, in its sole discretion, deems acceptable.

Costs associated with removal or replacement of overburden (items installed over the shingles, including but not limited to, solar panels, satellite dishes and gardens) are the sole responsibility of the property owner.

SureStart protection does not extend to any shingles applied to non-ventilated or inadequately ventilated roof deck systems as determined by CertainTeed, except as stated on page 4. CertainTeed's maximum contribution toward the cost of repairing or replacing defective shingles applied to a non-ventilated or inadequately ventilated roof deck system is calculated using the reasonable cost of comparable replacement shingles as determined by CertainTeed less 1/120th of that amount multiplied by the number of months from the start of the warranty period to the date when CertainTeed determines the shingles are defective. Labor costs, roof tear-off, metal work, flashing and disposal expenses, and other costs or expenses incurred during such repair or replacement are not covered or reimbursed by this Limited Warranty.

Beyond SureStart™ Protection

After the SureStart Protection period, if CertainTeed determines its shingles have a manufacturing defect, or for Other Ownership, if CertainTeed determines its shingles have a manufacturing defect that caused water penetration, CertainTeed's maximum contribution toward the cost of repairing or replacing defective shingles will be calculated using the reasonable cost of comparable replacement shingles as determined by CertainTeed less the Reduction Figure Per Month, specified in Table 1, for the number of months from the start of the warranty period to the date when CertainTeed determines the shingles are defective. Labor costs, roof tear-off, metal work, flashing and disposal expenses, and other costs or expenses incurred during such repair or replacement are not covered or reimbursed by this Limited Warranty.

TABLE 1

Lifetime Products^A	Warranty Period	SureStart Period	Wind Warranty Miles Per Hour	Algae Resistant Warranty Period¹	Reduction Figure Per Month
Grand Manor®	Lifetime ^A	10 Years	110"	30	1/600*
Presidential Shake® TL**	Lifetime ^A	10 Years	110"	30	1/600*
Landmark® TL**	Lifetime ^A	10 Years	110"	30	1/600*
Presidential Shake® (& IR) ^{2**}	Lifetime ^A	10 Years	110"	30	1/600*
Carriage House®	Lifetime ^A	10 Years	110"	30	1/600*
Belmont® (& IR) ²	Lifetime ^A	10 Years	110"	30	1/600*
Landmark® Premium	Lifetime ^A	10 Years	110"	30	1/600*
Landmark® PRO ²	Lifetime ^A	10 Years	110"	30	1/600*
NorthGate® ClimateFlex® ²	Lifetime ^A	10 Years	110"	30	1/600*
Highland Slate®	Lifetime ^A	10 Years	110"	25	1/600*

Lifetime Products^B	Warranty Period	SureStart Period	Wind Warranty Miles Per Hour	Algae Resistant Warranty Period¹	Reduction Figure Per Month
Landmark® ClimateFlex® ²	Lifetime ^B	10 Years	110"	25	1/600*
Landmark®**	Lifetime ^B	10 Years	110"	25	1/600*

25 Year Products	Warranty Period	SureStart Period	Wind Warranty Miles Per Hour	Algae Resistant Warranty Period	Reduction Figure Per Month
XT™ ²⁵	25 Years	5 Years	60	10	1/300

Any shingles applied to any inadequately ventilated roof deck

** Including Solaris colors. (see footnotes to Table 1)

FOOTNOTES TO TABLE 1.

- A. The Lifetime Warranty period is only available to individual property owners on premises used as their residence. The warranty period for Other Ownership for these shingles is limited to 50 years and the SureStart period is 10 years following the installation of the shingles. **Roof tear-off, metal work, flashing and disposal expense, incurred during repair or replacement are covered or reimbursed by this Limited Warranty.** Limited Warranty transferees during the SureStart™ period are limited to a 50-year warranty period (see section titled "Transfers During the SureStart Period" for details). All products under 30 year Algae Resistant Warranty period are prorated after 15 years.
- B. The Lifetime Warranty period is only available to individual property owners on premises used as their residence. The warranty period for Other Ownership for these shingles is limited to 40 years and the SureStart period is 5 years following the installation of the shingles. Limited Warranty transferees during the SureStart period are limited to a 40-year warranty period (see section titled "Transfers During the SureStart Period" for details). All products under 25 year Algae Resistant Warranty period are prorated after 10 years.

* For Lifetime products, at the completion of the 40th year the reduction figure will remain at 480/600, or 20% of the total maximum liability.

* For details of warranty coverage for shingles installed on inadequately ventilated roof decks on both residential and commercial buildings, see provisions under "Inadequately Ventilated and Non-Ventilated Decks."

** Wind warranty upgrade - These products are warranted to resist blow-off due to wind velocities, including gusts, up to a maximum of 130 miles per hour during the first fifteen (15) years, provided all of the following conditions are met:

- The CertainTeed shingles are not applied over existing roof shingles (roof-overs are not permitted).
- The CertainTeed specified corresponding hip and ridge accessory products are installed as cap shingles [Shadow Ridge®, Cedar Crest®, Shangle Ridge®, Mountain Ridge® and Landmark Solaris® (& IR)].
- The CertainTeed specified corresponding starter shingles are installed along the roof eaves and rakes (Swiftstart®, High-Performance Starter and Presidential® Starter).

(Note: In Florida, CertainTeed will waive the requirement of applying starter shingles along the roof rake if all of the following conditions are met: The applicable building code requires that asphalt roof shingles be embedded in an 8-inch-wide bed of asphalt roofing cement applied along the roof rake edges. And, the shingles are installed and embedded in an 8-inch-wide bed of asphalt roofing cement along the roof rake edges in accordance with the code.)

¹Algae Resistant Warranty period applies only to the Algae Resistant (AR) version of the pertinent shingle. Algae-Resistant Warranty Period: To get 25-year or 30-year Limited Algae-Resistant Warranty coverage, the original owner must install CertainTeed algae-resistant (AR) hip and ridge shingle accessories. Otherwise, Algae-Resistant Warranty Period coverage is limited to ten (10) years from the date of installation. However, Landmark AR Max Def will have a maximum 10-year Limited Algae-Resistant Warranty coverage regardless of the hip and ridge accessories installed.

²CertainTeed's Impact Resistant Landmark® ClimateFlex, NorthGate® ClimateFlex, Presidential Shake® IR, and Belmont® IR shingles comply with Class 4 UL 2218 Impact Resistance of Prepared Roof Covering Materials test criteria at time of manufacture. CertainTeed's Impact Resistant Landmark® PRO comply with Class 3 UL 2218 Impact Resistance of Prepared Roof Covering Materials test criteria at time of manufacture.

³The wind warranty for XT™25 shingles installed in Alaska is 90 mph.

Transferability

This Limited Warranty is transferable, but only by the original property owner/consumer to the first subsequent property owner. After the Limited Warranty has been transferred once, it is no longer transferable. A bank foreclosure or a change of ownership on a deed is deemed a transfer under this Limited Warranty.

Transfers During the SureStart™ Period

If this Limited Warranty is transferred during the product's SureStart period, the warranty for the new owner is the same as it would have been for the original owner, except for certain products with Lifetime warranty periods where the duration of the transferred warranty will be 50 years or 40 years as specified in Table 1, measured from the beginning of the SureStart period (i.e. the date of installation), and the remaining period of SureStart protection will be available to the subsequent property owner.

Transfers After the SureStart Period

If this Limited Warranty is transferred by the original property owner/consumer after the SureStart period, the warranty following the transfer will be limited to two (2) years from the date of the transfer. The warranty obligation will be calculated as explained in the section titled "Beyond SureStart Protection."

Limitations

This Limited Warranty does not provide protection against, and CertainTeed will have no liability for, any failure, defect or damage as a result of, including but not limited to:

- Winds, including gusts, greater than the Wind Warranty MPH in Table 1
- Damage caused by lightning, hailstorm, earthquake, fire, explosion, flood or falling objects.
- Damage caused by tornado, or hurricanes (other than as warranted under Wind Warranty MPH in Table 1).
- Distortion, cracking or other failure or movement of: the base material over which the shingles are applied, the roof deck, or the walls or foundation of the building itself.
- Damage caused by structural changes, alterations or additions, or by the installation of equipment (such as, but not limited to, aerials, signs or air-conditioning equipment) to the building after the original shingles have been applied.
- Shading, stains or discoloration to the shingles arising from outside sources such as, but not limited to, algae (unless blue-green algae as described in the section titled "Limited Algae Resistant Warranty"), fungus, moss, lichens or other vegetation, mold or mildew growth, or paints, chemicals or other similar materials.

- Misuse, abuse, neglect, or improper transportation, handling or storage of the shingles.
- Installation of the shingles over non-approved roof decks as more fully explained in CertainTeed's installation instructions published at the time of original installation.
- Damage caused by improper installation or installation not in accordance with CertainTeed's installation instructions published at the time of original installation.
- Damage to the shingles, the roof deck or the structure caused by ice backup or ice damming.
- Damage caused by impact, including such things as tools, equipment or foot traffic.
- Vandalism or acts of war.
- Animals, animal feces or insects.
- Any other cause not a result of a manufacturing defect in the shingles.

Mold and mildew are functions of environmental conditions and are not manufacturing defects. As such, mold and mildew are not covered by this Limited Warranty or any implied warranty.

CertainTeed reserves the right to discontinue or modify any of its products, including the color of its shingles, and shall not be liable as a result of such discontinuance or modification, nor shall CertainTeed be liable in the event replacement material varies in color in comparison to the original product as a result of normal weathering. If CertainTeed replaces any material under this warranty, it may substitute products designated by CertainTeed to be of comparable quality or price range in the event the product initially installed has been discontinued or modified.

Inadequately Ventilated and Non-Ventilated Decks

Any shingles applied to inadequately ventilated or non-ventilated decks, other than the shingles and deck systems described in the section titled "Insulated Decks and Radiant Barriers," are subject to a reduced limited warranty period of ten (10) years and do not qualify for SureStart Protection. SureStart™ Protection and the Warranty Period applicable to the shingle are available if CertainTeed determines that the shingle damage was caused exclusively by a manufacturing defect that is unrelated to the inadequate roof system ventilation.

Insulated Decks and Radiant Barriers

CertainTeed's Limited Warranty, including SureStart Protection, will remain in force when its fiberglass shingles are applied to roof deck assemblies where foam insulation is prefabricated into the roof deck system (often called "nailboard insulation"), where insulation is installed beneath an acceptable roof deck system, or where radiant barriers are installed, with or without ventilation, directly below the deck. Acceptable roof deck surfaces must consist of at least 3/8" thick plywood or 7/16" thick Oriented Strand Board (OSB) and slopes must be 2:12 or greater. If a different deck surface material will be utilized, please contact CertainTeed's Technical Services Department for assistance. (See the following important restrictions.)

The design professional is responsible for ensuring: 1) the proper quality and application of the insulation and/or radiant barrier, 2) the provision of adequate structural ventilation and/or vapor retarders as determined to be necessary, and 3) that all local codes are met (particularly taking into account local climate conditions). Special attention must be taken if cellular foam, fiberglass, cellulose insulation or other highly permeable insulation will be used in an unventilated system, or if the insulation/rafter or insulation/joist planes may create an air leak that could lead to moisture transmission and condensation problems. All these important factors and decisions, while not the responsibility of CertainTeed, are critical to assure proper deck system performance.

Ventilated Nail-Base Roof Insulation

Ventilated Nail-Base Roof Insulation products (e.g. FlintBoard® CV) are made of rigid insulation (typically foam board) and another layer of material that provides air space above the insulation and below the nailable deck (which is typically at least 7/16" thick OSB or 3/8" thick plywood). These products can provide soffit-to-ridge ventilation, and if installed in accordance with the deck manufacturer's instructions to achieve sufficient ventilation, will not reduce the scope or length of CertainTeed's Limited Warranty coverage.

Limited Algae-Resistant Warranty

For the Algae-Resistant Warranty Period listed in Table 1, CertainTeed warrants that should blue-green algae (*gloeocapsa magma*), which appears as black/brown streaks, adversely affect the appearance of its algae-resistant roofing shingles (designated as AR), CertainTeed, at its sole option, will pay to clean or replace the affected shingles, as described below.

If your shingles qualify for Limited Algae-Resistant Warranty coverage beyond ten (10) years, CertainTeed's maximum contribution towards cleaning or replacing shingles will be calculated using the Algae-Resistant Warranty Period specified in Table 1, less a prorated adjustment that reflects a reduction for the number of months that have elapsed from the date of installation to the date of the claim. This proration period will begin at ten (10) years for shingles qualifying for 25-year coverage, or fifteen (15) years for shingles qualifying for 30-year coverage. It will be CertainTeed's sole determination as to whether the staining or growth on the roof falls within the terms of this Limited Algae-Resistant Warranty coverage.

Coverage under the Limited Algae-Resistant Warranty is transferable. If the Limited Warranty is transferred during the SureStart Period, the coverage remaining of the Algae-Resistant Warranty Period continues from the date of transfer to the end of the Algae-Resistant Warranty Period specified in Table 1. If the Limited Warranty is transferred after the SureStart Period, coverage under the Limited Algae-Resistant Warranty continues either for any remainder of the Algae-Resistant Warranty Period or two (2) years, whichever is less.

WARNING: FOR LOW-VOLUME RAIN AND SALT FOG AREAS

In areas of low-volume rain (e.g. areas that receive insignificant rainfall during a 90-day period) and/or "salt fog" (e.g. parts of the Southern California coastline), copper released by algae-resistant (AR) granules or shingles can react with aluminum in gutters and cause severe corrosion of the gutters. In such regions, CertainTeed strongly recommends that vinyl or copper gutters, not aluminum gutters, be used with algae-resistant shingles. CertainTeed disclaims all liability and responsibility for any damages that may result from the use of its algae-resistant shingle products with copper granules where gutters containing aluminum are used.

Limited Wind Warranty

CertainTeed warrants its shingles will resist blow-off damage due to wind velocities, including gusts, up to the maximum wind velocity per the Wind Warranty MPH specified in Table 1 during the first fifteen (15) years of the warranty for Lifetime products and during the first five (5) years for all products listed in Table 1. CertainTeed's obligations and liability for shingle blow-off damage during the wind warranty periods as specified above are limited as follows:

CertainTeed's obligations and liability for shingle blow-off damage during the wind warranty periods as specified above are limited as follows:

- If shingles or hip/ridge accessories blow off because the self-sealing asphalt strips did not activate, CertainTeed will furnish replacement shingles without charge, but only for damaged or blown off shingles.
- If shingles or hip/ridge accessories blow off before the self-sealing asphalt strips could have reasonably activated due to installation in cold weather, CertainTeed will furnish replacement shingles without charge, but only for damaged or blown off shingles. CertainTeed will not be responsible for or reimburse labor costs, roof tear-off, metal work, flashing and disposal expenses, or any other costs pertaining to removal or replacement of damaged shingles. Any costs in excess of CertainTeed's material contribution are the property owner's responsibility (and may be covered by owner's insurance).
- CertainTeed shall have no liability for any shingles not fastened in accordance with CertainTeed installation instructions published at the time of original installation.
- CertainTeed shall have no liability for any damage to persons or property caused by blown off shingles.
- CertainTeed's maximum liability during the Limited Wind Warranty period is the reasonable cost of hand sealing all of the shingles on the roof.

Residential Low-Slope Roofing

Please refer to the CertainTeed Roofing Low-Slope Residential Limited Warranty.

What the Customer Must Do

If you believe your shingles have a manufacturing defect, you must notify CertainTeed within 30 days of discovery and provide proof of property ownership and the date of shingle purchase and application. Without original or sufficient proof of purchase CertainTeed reserves the right to use the shingle manufacturing date for claim calculation. In order to properly evaluate and process a warranty claim, CertainTeed may require the property owner to submit a shingle sample to CertainTeed for analysis and/or permit a CertainTeed representative to make repairs to, take photographs of, and/or take samples from the roof, if required. CertainTeed will evaluate each properly reported claim and will repair, replace, clean or reimburse the property owner for the shingles it determines are defective, in accordance with the terms of this Limited Warranty within a reasonable amount of time. For more details about submitting a warranty claim, visit ctroof.com or call (800) 345-1145.

Please send all notifications and correspondence to:
CertainTeed LLC, 805 West 5th Street, Suite # 7, Lansdale, PA 19446.
Attn: CertainTeed Roofing Technical Services Department. Telephone number: 800-345-1145.
Email: rpg.t.services@saint-gobain.com

Warranty Registration (not required)

You may register your product warranty on CertainTeed's website: certainteed.com/warrantyreg. Each registrant receives a registration confirmation number by return e-mail that can be printed and kept with this Limited Warranty and your proof of purchase. If you do not have internet access, you can register your shingles by sending: (1) your name, address, and telephone number; (2) the name and contact information of the contractor who installed your shingles and the original date of installation; and, (3) the type, color and number of squares of your shingles to: **CertainTeed LLC, 20 Moores Road, Malvern, PA 19355, Attn: CertainTeed Roofing Technical Services Department.**

CertainTeed will register your information and mail you a confirmation number. Failure to register this warranty does NOT void the warranty or any of its terms.

For Your Records

Product Purchased: _____ Date of Installation: _____

Roofing Contractor: _____ Contractor's Telephone No. _____

This warranty applies to shingles installed from June 1, 2023 to December 31, 2023
(The warranty in effect at the time the material is originally installed is the applicable warranty.)

Exclusive Warranty and Limitation of Remedies

THIS DOCUMENT CONSTITUTES THE EXCLUSIVE WARRANTIES AND REMEDIES PROVIDED BY CERTAINTEED. THE WARRANTIES AND REMEDIES CONTAINED IN THIS DOCUMENT ARE EXPRESSLY IN LIEU OF ANY AND ALL OTHER OBLIGATIONS, GUARANTEES, WARRANTIES AND REPRESENTATIONS, WHETHER WRITTEN, ORAL OR IMPLIED BY STATUTE, AT LAW OR IN EQUITY, INCLUDING WITHOUT LIMITATION, THE IMPLIED WARRANTIES OF MERCHANTABILITY AND FITNESS FOR A PARTICULAR PURPOSE. SOME STATES OR PROVINCES MAY NOT ALLOW THE EXCLUSION OF IMPLIED WARRANTIES OR MAY DETERMINE THE PERIOD OF TIME FOLLOWING THE SALE THAT A PURCHASER MAY SEEK A REMEDY UNDER IMPLIED WARRANTIES, SO THE ABOVE EXCLUSION MAY NOT APPLY TO YOU.

CERTAINTEED'S OBLIGATIONS, RESPONSIBILITIES, AND LIABILITY SHALL BE LIMITED TO REPAIRING OR REPLACING THE DEFECTIVE PRODUCT OR CLEANING ALGAE-RESISTANT SHINGLES IN THE CASE OF ALGAE GROWTH AS SET FORTH IN THIS LIMITED WARRANTY. IN NO EVENT SHALL CERTAINTEED BE LIABLE FOR ANY SPECIAL, INDIRECT, INCIDENTAL OR CONSEQUENTIAL DAMAGES OF ANY KIND, INCLUDING ANY DAMAGE TO THE PROPERTY, THE BUILDING OR ITS CONTENTS, OR FOR INJURY TO ANY PERSONS, THAT MAY OCCUR AS A RESULT OF THE USE OF CERTAINTEED'S PRODUCTS OR AS A RESULT OF THE BREACH OF THIS WARRANTY. IF YOUR STATE OR PROVINCE DOES NOT ALLOW EXCLUSIONS OR LIMITATIONS OF SPECIAL, INDIRECT, INCIDENTAL OR CONSEQUENTIAL DAMAGES, THE ABOVE LIMITATIONS MAY NOT APPLY TO YOU.

IN NO EVENT SHALL CERTAINTEED'S TOTAL LIABILITY ARISING OUT OF OR RELATED TO THE PRODUCT(S) OR THIS LIMITED WARRANTY EXCEED THE REASONABLE COST OF SHINGLES AND LABOR TO REPLACE OR REPAIR THE DEFECTIVE SHINGLES.

This Limited Warranty may not be modified, altered or expanded by anyone, including product distributors, dealers, sellers and/or CertainTeed field representatives.

This Limited Warranty gives you specific legal rights, and you may also have other rights which vary from State to State, or Province to Province.

Roofing Plants and Regional Sales Office

CertainTeed roofing products are sold by CertainTeed Roofing in nine sales regions. They are manufactured in ten residential roofing plants and one commercial roofing plant. Since the early 1900s, CertainTeed has been an innovator in the building materials industry and today is a leading manufacturer of building materials including residential and commercial roofing, vinyl siding, composite decking and railing, fiber glass insulation and vinyl fence products. The company is headquartered in Malvern, Pennsylvania, and employs more than 7,000 employees at approximately 60 manufacturing facilities throughout North America. Continuing the 100-year commitment of "Quality made certain, Satisfaction guaranteed™," CertainTeed remains one of the most trusted names in the industry. More information is available at certainteed.com.

This document is also available in Spanish and French.

Call 1-800-782-8777 or go to www.certainteed.com.

Se puede obtener este documento en español. Favor de llamar 1-800-782-8777.

Ce document est disponible en anglais et en espagnol. Composez le 1-800-782-8777.



Read
our blog



CertainTeed

CEILING • DECKING • FENCE • GYPSUM

INSULATION • RAILING • ROOFING • SIDING • TRIM

20 Moores Road, Malvern, PA 19355

Professional: 800-233-8990 Consumer: 800-782-8777

certainteed.com

Asphalt Shingle Residential Products

2024 Limited Warranty



Congratulations and thank you for your recent purchase of one of the fine products from CertainTeed Roofing! Since 1904, CertainTeed has been producing quality roofing products that provide long-lasting beauty and protection for homes of every size, style and age. For over 100 years, the basis for our name, "Quality made certain, satisfaction guaranteed," has been our ongoing philosophy.

Your CertainTeed roofing warranty fully explains how CertainTeed supports its products with the strongest warranty protection available. It is important that you read the warranty section of this brochure. The warranty lists the specific CertainTeed asphalt shingle products that are covered and the period of time for which they are covered. Take the time to understand how CertainTeed protects your purchase by standing behind our products.

Limited, Prorated and Transferable Warranty

This warranty covers asphalt shingle products listed in Table 1, sold only in the United States of America, its territories and Canada.

What and Who Are Covered and for How Long

From the date of installation, CertainTeed warrants to the original property owner/consumer that, when subject to normal and proper use, its shingles will be free from manufacturing defects for the warranty period specified in Table 1. CertainTeed will pay to repair, replace or clean, at its option, any shingles CertainTeed determines are defective under the terms of this Limited Warranty. In the event of repair, replacement or cleaning pursuant to the terms of this Limited Warranty, the warranty applicable to the original shingles shall apply to the repaired, replaced or cleaned shingles and will extend for the balance of the original warranty period.

Lifetime means for as long as the original individual property owner owns the property where the shingles are installed.

The Lifetime warranty period offered for certain shingles in Table 1 is only available to individual property owners. The warranty period for shingles installed on premises not used by individual property owners as their residence is limited as specified in Table 1. All property owners, who are not individual property owners, and all structures not used by individual property owners as their residence (e.g. corporations, governmental agencies, partnerships, religious organizations, schools, condominiums, property owner associations or cooperative housing arrangements, apartment buildings, and any other type of building or premises not owned by individual property owners) called "Other Ownership" are limited to either a 50-year or 40-year warranty period described in Table 1.

In addition, for Patriot Shingles and Other Ownership after the SureStart™ Protection period ends, this Limited Warranty only covers manufacturing defects that cause leaks.

SureStart™ Protection

Because CertainTeed roofing products are manufactured to the highest quality standards, we confidently include the additional assurance of SureStart™ protection. SureStart provides the strongest non-prorated protection you can get in the vital early years of your new roof.

All of CertainTeed's shingle products are covered by SureStart protection. Under this warranty feature, CertainTeed, at no charge, will pay to repair or replace, at its option, any shingles CertainTeed determines are defective during the SureStart period. Note: Wind warranty and algae warranty are covered separately as described on page 5. The SureStart period begins on the date of application and terminates following the warranty period specified in Table 1. CertainTeed's maximum liability under SureStart is equal to the reasonable cost of comparable replacement shingles and labor as determined by CertainTeed to replace or repair the defective shingles. Roof tear-off, metal work, flashing and disposal expenses, and other costs or expenses incurred during such repair or replacement are not covered or reimbursed by this Limited Warranty, except for certain products with Lifetime warranty periods specified in Table 1, for which CertainTeed's maximum liability also includes the cost of roof tear-off, metal work, flashing and disposal.

In instances in which CertainTeed, under the terms of this warranty, has agreed to pay the reasonable cost of labor required to repair or replace defective shingles, CertainTeed will determine labor costs by Bluebook® or RS Means® data. CertainTeed will provide reimbursement for labor only upon receipt of a copy of the contractor's invoice or other written evidence of the completion of such work which CertainTeed, in its sole discretion, deems acceptable.

Costs associated with removal or replacement of overburden (items installed over the shingles, including but not limited to, solar panels, satellite dishes and gardens) are the sole responsibility of the property owner.

SureStart protection does not extend to any shingles applied to non-ventilated or inadequately ventilated roof deck systems as determined by CertainTeed, except as stated on page 4. CertainTeed's maximum contribution toward the cost of repairing or replacing defective shingles applied to a non-ventilated or inadequately ventilated roof deck system is calculated using the reasonable cost of comparable replacement shingles as determined by CertainTeed less 1/120th of that amount multiplied by the number of months from the start of the warranty period to the date when CertainTeed determines the shingles are defective. Labor costs, roof tear-off, metal work, flashing and disposal expenses, and other costs or expenses incurred during such repair or replacement are not covered or reimbursed by this Limited Warranty. For Patriot Shingles and Other Ownership to be covered under this section, the manufacturing defect must cause leaks.

Beyond SureStart™ Protection

After the SureStart Protection period, if CertainTeed determines its shingles have a manufacturing defect, CertainTeed's maximum contribution toward the cost of repairing or replacing defective shingles will be calculated using the reasonable cost of comparable replacement shingles as determined by CertainTeed less the Reduction Figure Per Month, specified in Table 1, for the number of months from the start of the warranty period to the date when CertainTeed determines the shingles are defective. Labor costs, roof tear-off, metal work, flashing and disposal expenses, and other costs or expenses incurred during such repair or replacement are not covered or reimbursed by this Limited Warranty. For Patriot Shingles and Other Ownership to be covered under this section, the manufacturing defect must cause leaks.

TABLE 1

Lifetime Products ^A	Warranty Period	SureStart Period	Wind Warranty Miles Per Hour	Algae Resistant Warranty Period ¹	Reduction Figure Per Month
Grand Manor®	Lifetime ^A	10 Years	110"	30	1/600*
Presidential Shake® TL**	Lifetime ^A	10 Years	110"	30	1/600*
Landmark® TL**	Lifetime ^A	10 Years	110"	30	1/600*
Presidential Shake® (& IR)**	Lifetime ^A	10 Years	110"	30	1/600*
Carriage House®	Lifetime ^A	10 Years	110"	30	1/600*
Belmont® (& IR) ²	Lifetime ^A	10 Years	110"	30	1/600*
Landmark® Premium	Lifetime ^A	10 Years	110"	30	1/600*
Landmark® PRO ²	Lifetime ^A	10 Years	110"	30	1/600*
NorthGate® ClimateFlex ^{*2}	Lifetime ^A	10 Years	110"	30	1/600*
Highland Slate®	Lifetime ^A	10 Years	110"	25	1/600*

Lifetime Products ^B	Warranty Period	SureStart Period	Wind Warranty Miles Per Hour	Algae Resistant Warranty Period ¹	Reduction Figure Per Month
Landmark® ClimateFlex ^{*2}	Lifetime ^B	10 Years	110"	25	1/600*
Landmark ^{***}	Lifetime ^B	10 Years	110"	25	1/600*
Patriot	Lifetime ^B	10 Years	110"	10	1/600*

25 Year Products	Warranty Period	SureStart Period	Wind Warranty Miles Per Hour	Algae Resistant Warranty Period	Reduction Figure Per Month
XT™25 ³	25 Years	5 Years	60	10	1/300
Any shingles applied to any inadequately ventilated roof deck	10 years [†]	N/A	N/A	N/A	1/120

** Including Solaris colors. (see footnotes to Table 1)

FOOTNOTES TO TABLE 1.

- A. The Lifetime Warranty period is only available to individual property owners on premises used as their residence. The warranty period for Other Ownership for these shingles is limited to 50 years and the SureStart period is 10 years following the installation of the shingles. **Roof tear-off, metal work, flashing and disposal expense, incurred during repair or replacement are covered or reimbursed by this Limited Warranty.** Limited Warranty transferees during the SureStart™ period are limited to a 50-year warranty period (see section titled "Transfers During the SureStart Period" for details). All products under 30 year Algae Resistant Warranty period are prorated after 15 years.
- B. The Lifetime Warranty period is only available to individual property owners on premises used as their residence. The warranty period for Other Ownership for these shingles is limited to 40 years and the SureStart period is 5 years following the installation of the shingles. Limited Warranty transferees during the SureStart period are limited to a 40-year warranty period (see section titled "Transfers During the SureStart Period" for details). All products under 25 year Algae Resistant Warranty period are prorated after 10 years.

* For Lifetime products, at the completion of the 40th year the reduction figure will remain at 480/600, or 20% of the total maximum liability.

* For details of warranty coverage for shingles installed on inadequately ventilated roof decks on both residential and commercial buildings, see provisions under "Inadequately Ventilated and Non-Ventilated Decks."

** Wind warranty upgrade - These products are warranted to resist blow-off due to wind velocities, including gusts, up to a maximum of 130 miles per hour during the first fifteen (15) years, provided all of the following conditions are met:

- The CertainTeed shingles are not applied over existing roof shingles (roof-overs are not permitted).
- The CertainTeed specified corresponding hip and ridge accessory products are installed as cap shingles [Shadow Ridge®, Cedar Crest®, Shangle Ridge®, Mountain Ridge® and Landmark Solaris® (& IR)].
- The CertainTeed specified corresponding starter shingles are installed along the roof eaves and rakes (Swiftstart®, High-Performance Starter and Presidential® Starter).

(Note: In Florida, CertainTeed will waive the requirement of applying starter shingles along the roof rake if all of the following conditions are met: The applicable building code requires that asphalt roof shingles be embedded in an 8-inch-wide bed of asphalt roofing cement applied along the roof rake edges. And, the shingles are installed and embedded in an 8-inch-wide bed of asphalt roofing cement along the roof rake edges in accordance with the code.)

¹Algae Resistant Warranty period applies only to the Algae Resistant (AR) version of the pertinent shingle. Algae-Resistant Warranty Period: To get 25-year or 30-year Limited Algae-Resistant Warranty coverage, the original owner must install CertainTeed algae-resistant (AR) hip and ridge shingle accessories. Otherwise, Algae-Resistant Warranty Period coverage is limited to ten (10) years from the date of installation. However, Landmark AR Max Def will have a maximum 10-year Limited Algae-Resistant Warranty coverage regardless of the hip and ridge accessories installed.

²CertainTeed's Impact Resistant Landmark® ClimateFlex, NorthGate® ClimateFlex, Presidential Shake® IR, and Belmont® IR shingles comply with Class 4 UL 2218 Impact Resistance of Prepared Roof Covering Materials test criteria at time of manufacture. CertainTeed's Impact Resistant Landmark® PRO comply with Class 3 UL 2218 Impact Resistance of Prepared Roof Covering Materials test criteria at time of manufacture.

³The wind warranty for XT™25 shingles installed in Alaska is 90 mph.

Transferability

This Limited Warranty is transferable, but only by the original property owner/consumer to the first subsequent property owner. After the Limited Warranty has been transferred once, it is no longer transferable. A bank foreclosure or a change of ownership on a deed is deemed a transfer under this Limited Warranty.

Transfers During the SureStart™ Period

If this Limited Warranty is transferred during the product's SureStart period, the warranty for the new owner is the same as it would have been for the original owner, except for certain products with Lifetime warranty periods where the duration of the transferred warranty will be 50 years or 40 years as specified in Table 1, measured from the beginning of the SureStart period (i.e. the date of installation), and the remaining period of SureStart protection will be available to the subsequent property owner.

Transfers After the SureStart Period

If this Limited Warranty is transferred by the original property owner/consumer after the SureStart period, the warranty following the transfer will be limited to two (2) years from the date of the transfer. The warranty obligation will be calculated as explained in the section titled "Beyond SureStart Protection."

Limitations

This Limited Warranty does not provide protection against, and CertainTeed will have no liability for, any failure, defect or damage as a result of, including but not limited to:

- Winds, including gusts, greater than the Wind Warranty MPH in Table 1
- Damage caused by lightning, hailstorm, earthquake, fire, explosion, flood or falling objects.
- Damage caused by tornado, or hurricanes (other than as warranted under Wind Warranty MPH in Table 1).
- Distortion, cracking or other failure or movement of: the base material over which the shingles are applied, the roof deck, or the walls or foundation of the building itself.
- Damage caused by structural changes, alterations or additions, or by the installation of equipment (such as, but not limited to, aerials, signs or air-conditioning equipment) to the building after the original shingles have been applied.
- Shading, stains or discoloration to the shingles arising from outside sources such as, but not limited to, algae (unless blue-green algae as described in the section titled "Limited Algae Resistant Warranty"), fungus, moss, lichens or other vegetation, mold or mildew growth, or paints, chemicals or other similar materials.

- Misuse, abuse, neglect, or improper transportation, handling or storage of the shingles.
- Installation of the shingles over non-approved roof decks as more fully explained in CertainTeed's installation instructions published at the time of original installation.
- Damage caused by improper installation or installation not in accordance with CertainTeed's installation instructions published at the time of original installation.
- Damage to the shingles, the roof deck or the structure caused by ice backup or ice damming.
- Damage caused by impact, including such things as tools, equipment or foot traffic.
- Vandalism or acts of war.
- Animals, animal feces or insects.
- Any other cause not a result of a manufacturing defect in the shingles.

Mold and mildew are functions of environmental conditions and are not manufacturing defects. As such, mold and mildew are not covered by this Limited Warranty or any implied warranty.

CertainTeed reserves the right to discontinue or modify any of its products, including the color of its shingles, and shall not be liable as a result of such discontinuance or modification, nor shall CertainTeed be liable in the event replacement material varies in color in comparison to the original product as a result of normal weathering. If CertainTeed replaces any material under this warranty, it may substitute products designated by CertainTeed to be of comparable quality or price range in the event the product initially installed has been discontinued or modified.

Inadequately Ventilated and Non-Ventilated Decks

Any shingles applied to inadequately ventilated or non-ventilated decks, other than the shingles and deck systems described in the section titled "Insulated Decks and Radiant Barriers," are subject to a reduced limited warranty period of ten (10) years and do not qualify for SureStart Protection. SureStart™ Protection and the Warranty Period applicable to the shingle are available if CertainTeed determines that the shingle damage was caused exclusively by a manufacturing defect that is unrelated to the inadequate roof system ventilation.

Insulated Decks and Radiant Barriers

CertainTeed's Limited Warranty, including SureStart Protection, will remain in force when its fiberglass shingles are applied to roof deck assemblies where foam insulation is prefabricated into the roof deck system (often called "nailboard insulation"), where insulation is installed beneath an acceptable roof deck system, or where radiant barriers are installed, with or without ventilation, directly below the deck. Acceptable roof deck surfaces must consist of at least 3/8" thick plywood or 7/16" thick Oriented Strand Board (OSB) and slopes must be 2:12 or greater. If a different deck surface material will be utilized, please contact CertainTeed's Technical Services Department for assistance. (See the following important restrictions.)

The design professional is responsible for ensuring: 1) the proper quality and application of the insulation and/or radiant barrier, 2) the provision of adequate structural ventilation and/or vapor retarders as determined to be necessary, and 3) that all local codes are met (particularly taking into account local climate conditions). Special attention must be taken if cellular foam, fiberglass, cellulose insulation or other highly permeable insulation will be used in an unventilated system, or if the insulation/rafter or insulation/joist planes may create an air leak that could lead to moisture transmission and condensation problems. All these important factors and decisions, while not the responsibility of CertainTeed, are critical to assure proper deck system performance.

Ventilated Nail-Base Roof Insulation

Ventilated Nail-Base Roof Insulation products (e.g. FlintBoard® CV) are made of rigid insulation (typically foam board) and another layer of material that provides air space above the insulation and below the nailable deck (which is typically at least 7/16" thick OSB or 3/8" thick plywood). These products can provide soffit-to-ridge ventilation, and if installed in accordance with the deck manufacturer's instructions to achieve sufficient ventilation, will not reduce the scope or length of CertainTeed's Limited Warranty coverage.

Limited Algae-Resistant Warranty

For the Algae-Resistant Warranty Period listed in Table 1, CertainTeed warrants that should blue-green algae (*gloeocapsa magma*), which appears as black/brown streaks, adversely affect the appearance of its algae-resistant roofing shingles (designated as AR), CertainTeed, at its sole option, will pay to clean or replace the affected shingles, as described below.

If your shingles qualify for Limited Algae-Resistant Warranty coverage beyond ten (10) years, CertainTeed's maximum contribution towards cleaning or replacing shingles will be calculated using the Algae-Resistant Warranty Period specified in Table 1, less a prorated adjustment that reflects a reduction for the number of months that have elapsed from the date of installation to the date of the claim. This proration period will begin at ten (10) years for shingles qualifying for 25-year coverage, or fifteen (15) years for shingles qualifying for 30-year coverage. It will be CertainTeed's sole determination as to whether the staining or growth on the roof falls within the terms of this Limited Algae-Resistant Warranty coverage.

Coverage under the Limited Algae-Resistant Warranty is transferable. If the Limited Warranty is transferred during the SureStart Period, the coverage remaining of the Algae-Resistant Warranty Period continues from the date of transfer to the end of the Algae-Resistant Warranty Period specified in Table 1. If the Limited Warranty is transferred after the SureStart Period, coverage under the Limited Algae-Resistant Warranty continues either for any remainder of the Algae-Resistant Warranty Period or two (2) years, whichever is less.

WARNING: FOR LOW-VOLUME RAIN AND SALT FOG AREAS

In areas of low-volume rain (e.g. areas that receive insignificant rainfall during a 90-day period) and/or "salt fog" (e.g. parts of the Southern California coastline), copper released by algae-resistant (AR) granules or shingles can react with aluminum in gutters and cause severe corrosion of the gutters. In such regions, CertainTeed strongly recommends that vinyl or copper gutters, not aluminum gutters, be used with algae-resistant shingles. CertainTeed disclaims all liability and responsibility for any damages that may result from the use of its algae-resistant shingle products with copper granules where gutters containing aluminum are used.

Limited Wind Warranty

CertainTeed warrants its shingles will resist blow-off damage due to wind velocities, including gusts, up to the maximum wind velocity per the Wind Warranty MPH specified in Table 1 during the first fifteen (15) years of the warranty for Lifetime products and during the first five (5) years for all products listed in Table 1. CertainTeed's obligations and liability for shingle blow-off damage during the wind warranty periods as specified above are limited as follows:

CertainTeed's obligations and liability for shingle blow-off damage during the wind warranty periods as specified above are limited as follows:

- If shingles or hip/ridge accessories blow off because the self-sealing asphalt strips did not activate, CertainTeed will furnish replacement shingles without charge, but only for damaged or blown off shingles.
- If shingles or hip/ridge accessories blow off before the self-sealing asphalt strips could have reasonably activated due to installation in cold weather, CertainTeed will furnish replacement shingles without charge, but only for damaged or blown off shingles. CertainTeed will not be responsible for or reimburse labor costs, roof tear-off, metal work, flashing and disposal expenses, or any other costs pertaining to removal or replacement of damaged shingles. Any costs in excess of CertainTeed's material contribution are the property owner's responsibility (and may be covered by owner's insurance).
- CertainTeed shall have no liability for any shingles not fastened in accordance with CertainTeed installation instructions published at the time of original installation.
- CertainTeed shall have no liability for any damage to persons or property caused by blown off shingles.
- CertainTeed's maximum liability during the Limited Wind Warranty period is the reasonable cost of hand sealing all of the shingles on the roof.

Residential Low-Slope Roofing

Please refer to the CertainTeed Roofing Low-Slope Residential Limited Warranty.

What the Customer Must Do

If you believe your shingles have a manufacturing defect, you must notify CertainTeed within 30 days of discovery and provide proof of property ownership and the date of shingle purchase and application. Without original or sufficient proof of purchase CertainTeed reserves the right to use the shingle manufacturing date for claim calculation. In order to properly evaluate and process a warranty claim, CertainTeed may require the property owner to submit a shingle sample to CertainTeed for analysis and/or permit a CertainTeed representative to make repairs to, take photographs of, and/or take samples from the roof, if required. CertainTeed will evaluate each properly reported claim and will repair, replace, clean or reimburse the property owner for the shingles it determines are defective, in accordance with the terms of this Limited Warranty within a reasonable amount of time. For more details about submitting a warranty claim, visit ctroof.com or call (800) 345-1145.

Please send all notifications and correspondence to:
CertainTeed LLC, 805 West 5th Street, Suite # 7, Lansdale, PA 19446.
Attn: CertainTeed Roofing Technical Services Department. Telephone number: 800-345-1145.
Email: rpg.t.services@saint-gobain.com

Warranty Registration (not required)

You may register your product warranty on CertainTeed's website: certainteed.com/warrantyreg. Each registrant receives a registration confirmation number by return e-mail that can be printed and kept with this Limited Warranty and your proof of purchase. If you do not have internet access, you can register your shingles by sending: (1) your name, address, and telephone number; (2) the name and contact information of the contractor who installed your shingles and the original date of installation; and, (3) the type, color and number of squares of your shingles to: **CertainTeed LLC, 20 Moores Road, Malvern, PA 19355, Attn: CertainTeed Roofing Technical Services Department.**

CertainTeed will register your information and mail you a confirmation number. Failure to register this warranty does NOT void the warranty or any of its terms.

For Your Records

Product Purchased: _____ Date of Installation: _____

Roofing Contractor: _____ Contractor's Telephone No. _____

This warranty applies to shingles installed from January 1, 2024 to December 31, 2024
(The warranty in effect at the time the material is originally installed is the applicable warranty.)

Exclusive Warranty and Limitation of Remedies

THIS DOCUMENT CONSTITUTES THE EXCLUSIVE WARRANTIES AND REMEDIES PROVIDED BY CERTAINTEED. THE WARRANTIES AND REMEDIES CONTAINED IN THIS DOCUMENT ARE EXPRESSLY IN LIEU OF ANY AND ALL OTHER OBLIGATIONS, GUARANTEES, WARRANTIES AND REPRESENTATIONS, WHETHER WRITTEN, ORAL OR IMPLIED BY STATUTE, AT LAW OR IN EQUITY, INCLUDING WITHOUT LIMITATION, THE IMPLIED WARRANTIES OF MERCHANTABILITY AND FITNESS FOR A PARTICULAR PURPOSE. SOME STATES OR PROVINCES MAY NOT ALLOW THE EXCLUSION OF IMPLIED WARRANTIES OR MAY DETERMINE THE PERIOD OF TIME FOLLOWING THE SALE THAT A PURCHASER MAY SEEK A REMEDY UNDER IMPLIED WARRANTIES, SO THE ABOVE EXCLUSION MAY NOT APPLY TO YOU.

CERTAINTEED'S OBLIGATIONS, RESPONSIBILITIES, AND LIABILITY SHALL BE LIMITED TO REPAIRING OR REPLACING THE DEFECTIVE PRODUCT OR CLEANING ALGAE-RESISTANT SHINGLES IN THE CASE OF ALGAE GROWTH AS SET FORTH IN THIS LIMITED WARRANTY. IN NO EVENT SHALL CERTAINTEED BE LIABLE FOR ANY SPECIAL, INDIRECT, INCIDENTAL OR CONSEQUENTIAL DAMAGES OF ANY KIND, INCLUDING ANY DAMAGE TO THE PROPERTY, THE BUILDING OR ITS CONTENTS, OR FOR INJURY TO ANY PERSONS, THAT MAY OCCUR AS A RESULT OF THE USE OF CERTAINTEED'S PRODUCTS OR AS A RESULT OF THE BREACH OF THIS WARRANTY. IF YOUR STATE OR PROVINCE DOES NOT ALLOW EXCLUSIONS OR LIMITATIONS OF SPECIAL, INDIRECT, INCIDENTAL OR CONSEQUENTIAL DAMAGES, THE ABOVE LIMITATIONS MAY NOT APPLY TO YOU.

IN NO EVENT SHALL CERTAINTEED'S TOTAL LIABILITY ARISING OUT OF OR RELATED TO THE PRODUCT(S) OR THIS LIMITED WARRANTY EXCEED THE REASONABLE COST OF SHINGLES AND LABOR TO REPLACE OR REPAIR THE DEFECTIVE SHINGLES.

This Limited Warranty may not be modified, altered or expanded by anyone, including product distributors, dealers, sellers and/or CertainTeed field representatives.

This Limited Warranty gives you specific legal rights, and you may also have other rights which vary from State to State, or Province to Province.

Roofing Plants and Regional Sales Office

CertainTeed roofing products are sold by CertainTeed Roofing in nine sales regions. They are manufactured in ten residential roofing plants and one commercial roofing plant. Since the early 1900s, CertainTeed has been an innovator in the building materials industry and today is a leading manufacturer of building materials including residential and commercial roofing, vinyl siding, composite decking and railing, fiber glass insulation and vinyl fence products. The company is headquartered in Malvern, Pennsylvania, and employs more than 7,000 employees at approximately 60 manufacturing facilities throughout North America. Continuing the 100-year commitment of "Quality made certain, Satisfaction guaranteed™," CertainTeed remains one of the most trusted names in the industry. More information is available at certainteed.com.

This document is also available in Spanish and French.

Call 1-800-782-8777 or go to www.certainteed.com.

Se puede obtener este documento en español. Favor de llamar 1-800-782-8777.

Ce document est disponible en anglais et en espagnol. Composez le 1-800-782-8777.



Read
our blog



CertainTeed

CEILING • DECKING • FENCE • GYPSUM

INSULATION • RAILING • ROOFING • SIDING • TRIM

20 Moores Road, Malvern, PA 19355

Professional: 800-233-8990 Consumer: 800-782-8777

certainteed.com

**ASPHALT SHINGLE
& LOW-SLOPE
RESIDENTIAL PRODUCTS**
2022 Limited Warranty



Congratulations... and thank you for your recent purchase of one of the fine products from CertainTeed Roofing. Since 1904, CertainTeed has been producing quality roofing products that provide long-lasting beauty and protection for homes of every size, style and age. For over 100 years, the basis for our name, "Quality made certain, satisfaction guaranteed," has been our ongoing philosophy.

Your CertainTeed roofing warranty fully explains how CertainTeed supports its products with the strongest warranty protection available. It is important that you read the warranty section of this brochure. The warranty lists the specific CertainTeed asphalt shingle products that are covered and the period of time for which they are covered. Take the time to understand how CertainTeed protects your purchase by standing behind our products.

Limited, Prorated and Transferable Warranty

This warranty covers asphalt shingle products listed in Table 1, sold only in the United States of America, its territories and Canada.

What and Who Are Covered and for How Long

From the date of installation, CertainTeed warrants to the original property owner/consumer that, when subject to normal and proper use, its shingles will be free from manufacturing defects for the warranty period specified in Table 1. CertainTeed will pay to repair, replace or clean, at its option, any shingles CertainTeed determines are defective under the terms of this Limited Warranty. In the event of repair, replacement or cleaning pursuant to the terms of this Limited Warranty, the warranty applicable to the original shingles shall apply to the repaired, replaced or cleaned shingles and will extend for the balance of the original warranty period.

Lifetime means for as long as the original individual property owner owns the property where the shingles are installed.

The Lifetime warranty period offered for certain shingles in Table 1 is only available to individual property owners. The warranty period for shingles installed on premises not used by individual property owners as their residence is limited as specified in Table 1. All property owners, who are not individual property owners, and all structures not used by individual property owners as their residence (e.g. corporations, governmental agencies, partnerships, religious organizations, schools, condominiums, property owner associations or cooperative housing arrangements, apartment buildings, and any other type of building or premises not owned by individual property owners) called "Other Ownership" are limited to either a 50-year or 40-year warranty period described in Table 1. In addition, for Other Ownership after the SureStart™ Protection period ends, this Limited Warranty covers only manufacturing defects that caused water penetration.

SureStart™ Protection

Because CertainTeed roofing products are manufactured to the highest quality standards, we confidently include the additional assurance of SureStart™ protection. SureStart provides the strongest non-prorated protection you can get in the vital early years of your new roof.

All of CertainTeed's shingle products are covered by SureStart protection. Under this warranty feature, CertainTeed, at no charge, will pay to repair or replace, at its option, any shingles CertainTeed determines are defective during the SureStart period. Note: Wind warranty and algae warranty are covered separately as described on page 5. The SureStart period begins on the date of application and terminates following the warranty period specified in Table 1. CertainTeed's maximum liability under SureStart is equal to the reasonable cost of comparable replacement shingles and labor as determined by CertainTeed to replace or repair the defective shingles. Roof tear-off, metal work, flashing and disposal expenses, and other costs or expenses incurred during such repair or replacement are not covered or reimbursed by this Limited Warranty, except for certain products with Lifetime warranty periods specified in Table 1, for which CertainTeed's maximum liability also includes the cost of roof tear-off, metal work, flashing and disposal.

In instances in which CertainTeed, under the terms of this warranty, has agreed to pay the reasonable cost of labor required to repair or replace defective shingles, CertainTeed will determine labor costs by Bluebook® or RS Means® data. CertainTeed will provide reimbursement for labor only upon receipt of a copy of the contractor's invoice or other written evidence of the completion of such work which CertainTeed, in its sole discretion, deems acceptable.

Costs associated with removal or replacement of overburden (items installed over the shingles, including but not limited to, solar panels, satellite dishes and gardens) are the sole responsibility of the property owner.

SureStart protection does not extend to any shingles applied to non-ventilated or inadequately ventilated roof deck systems as determined by CertainTeed, except as stated on page 4. CertainTeed's maximum contribution toward the cost of repairing or replacing defective shingles applied to a non-ventilated or inadequately ventilated roof deck system is calculated using the reasonable cost of comparable replacement shingles as determined by CertainTeed less 1/120th of that amount multiplied by the number of months from the start of the warranty period to the date when CertainTeed determines the shingles are defective. Labor costs, roof tear-off, metal work, flashing and disposal expenses, and other costs or expenses incurred during such repair or replacement are not covered or reimbursed by this Limited Warranty.

Beyond SureStart™ Protection

After the SureStart Protection period, if CertainTeed determines its shingles have a manufacturing defect, or for Other Ownership, if CertainTeed determines its shingles have a manufacturing defect that caused water penetration, CertainTeed's maximum contribution toward the cost of repairing or replacing defective shingles will be calculated using the reasonable cost of comparable replacement shingles as determined by CertainTeed less the Reduction Figure Per Month, specified in Table 1, for the number of months from the start of the warranty period to the date when CertainTeed determines the shingles are defective. Labor costs, roof tear-off, metal work, flashing and disposal expenses, and other costs or expenses incurred during such repair or replacement are not covered or reimbursed by this Limited Warranty.

TABLE 1

<u>Lifetime Products^A</u>	<u>Warranty Period</u>	<u>SureStart Period</u>	<u>Wind Warranty Miles Per Hour</u>	<u>Algae Resistant Warranty Period¹</u>	<u>Reduction Figure Per Month</u>
Grand Manor® Presidential Shake® TL** Landmark® TL** Presidential Shake® (& IR) ^{2**} Carriage House® Belmont® (& IR) ² Landmark® Premium Landmark® PRO NorthGate® ClimateFlex® ² Highland Slate®	Lifetime ^A	10 Years	110 ^{**}	15	1/600*

<u>Lifetime Products^B</u>	<u>Warranty Period</u>	<u>SureStart Period</u>	<u>Wind Warranty Miles Per Hour</u>	<u>Algae Resistant Warranty Period¹</u>	<u>Reduction Figure Per Month</u>
Landmark® ClimateFlex® ²	Lifetime ^B	10 Years	110 ^{**}	10	1/600*
Landmark ^{***}	Lifetime ^B	10 Years	110 ^{**}	10	1/600*

<u>25 Year Product</u>	<u>Warranty Period</u>	<u>SureStart Period</u>	<u>Wind Warranty Miles Per Hour</u>	<u>Algae Resistant Warranty Period¹</u>	<u>Reduction Figure Per Month</u>
XT™ ²⁵	25 Years	5 Years	60	10	1/300
Any shingles applied to any inadequately ventilated roof deck	10 years [†]	N/A	N/A	N/A	1/120

** Including Solaris colors.
(see footnotes to Table 1)

FOOTNOTES TO TABLE 1.

A. The Lifetime Warranty period is only available to individual property owners on premises used as their residence. The warranty period for Other Ownership for these shingles is limited to 50 years and the SureStart period is 10 years following the installation of the shingles. **Roof tear-off, metal work, flashing and disposal expense, incurred during repair or replacement are covered or reimbursed by this Limited Warranty.** Limited Warranty transferees during the SureStart™ period are limited to a 50-year warranty period (see section titled "Transfers During the SureStart Period" for details).

B. The Lifetime Warranty period is only available to individual property owners on premises used as their residence. The warranty period for Other Ownership for these shingles is limited to 40 years and the SureStart period is 5 years following the installation of the shingles. Limited Warranty transferees during the SureStart period are limited to a 40-year warranty period (see section titled "Transfers During the SureStart Period" for details).

* For Lifetime products, at the completion of the 40th year the reduction figure will remain at 480/600, or 20% of the total maximum liability.

^f For details of warranty coverage for shingles installed on inadequately ventilated roof decks on both residential and commercial buildings, see provisions under "Inadequately Ventilated and Non-Ventilated Decks."

^{††} Wind warranty upgrade - These products are warranted to resist blow-off due to wind velocities, including gusts, up to a maximum of 130 miles per hour during the first fifteen (15) years, provided all of the following conditions are met:

1. The CertainTeed shingles are not applied over existing roof shingles (roof-overs are not permitted).
2. The CertainTeed specified corresponding hip and ridge accessory products are installed as cap shingles [Shadow Ridge®, Cedar Crest®, Shangle Ridge®, Mountain Ridge® and Landmark Solaris® (& IR)].
3. The CertainTeed specified corresponding starter shingles are installed along the roof eaves and rakes (Swiftstart®, High-Performance Starter and Presidential® Starter).

(Note: In Florida, CertainTeed will waive the requirement of applying starter shingles along the roof rake if all of the following conditions are met: The applicable building code requires that asphalt roof shingles be embedded in an 8-inch-wide bed of asphalt roofing cement applied along the roof rake edges. And, the shingles are installed and embedded in an 8-inch-wide bed of asphalt roofing cement along the roof rake edges in accordance with the code.)

¹Algae Resistant Warranty period applies only to the Algae Resistant (AR) version of the pertinent shingle.

²CertainTeed's Impact Resistant Landmark®, ClimateFlex®, NorthGate®, ClimateFlex®, Presidential Shake® IR, and Belmont® IR shingles comply with UL 2218 Impact Resistance of Prepared Roof Covering Materials test criteria at time of manufacture.

³The wind warranty for XT™25 shingles installed in Alaska is 90 mph.

Transferability

This Limited Warranty is transferable, but only by the original property owner/consumer to the first subsequent property owner. After the Limited Warranty has been transferred once, it is no longer transferable. A bank foreclosure or a change of ownership on a deed is deemed a transfer under this Limited Warranty.

Transfers During the SureStart™ Period

If this Limited Warranty is transferred during the product's SureStart period, the warranty for the new owner is the same as it would have been for the original owner, except for certain products with Lifetime warranty periods where the duration of the transferred warranty will be 50 years or 40 years as specified in Table 1, measured from the beginning of the SureStart period (i.e. the date of installation), and the remaining period of SureStart protection will be available to the subsequent property owner.

Transfers After the SureStart Period

If this Limited Warranty is transferred by the original property owner/consumer after the SureStart period, the warranty following the transfer will be limited to two (2) years from the date of the transfer. The warranty obligation will be calculated as explained in the section titled "Beyond SureStart Protection."

Limitations

This Limited Warranty does not provide protection against, and CertainTeed will have no liability for, any failure, defect or damage as a result of, including but not limited to:

- Winds, including gusts, greater than the Wind Warranty MPH in Table 1
- Damage caused by lightning, hailstorm, earthquake, fire, explosion, flood or falling objects.
- Damage caused by tornado, or hurricanes (other than as warranted under Wind Warranty MPH in Table 1).
- Distortion, cracking or other failure or movement of: the base material over which the shingles are applied, the roof deck, or the walls or foundation of the building itself.
- Damage caused by structural changes, alterations or additions, or by the installation of equipment (such as, but not limited to, aerials, signs or air-conditioning equipment) to the building after the original shingles have been applied.
- Shading, stains or discoloration to the shingles arising from outside sources such as, but not limited to, algae (unless blue-green algae as described in the section titled "Limited Algae Resistant Warranty"), fungus, moss, lichens or other vegetation, mold or mildew growth, or paints, chemicals or other similar materials.
- Misuse, abuse, neglect, or improper transportation, handling or storage of the shingles.
- Installation of the shingles over non-approved roof decks as more fully explained in CertainTeed's installation instructions published at the time of original installation.

- Damage caused by improper installation or installation not in accordance with CertainTeed's installation instructions published at the time of original installation.
- Damage to the shingles, the roof deck or the structure caused by ice backup or ice damming.
- Damage caused by impact, including such things as tools, equipment or foot traffic.
- Vandalism or acts of war.
- Animals, animal feces or insects.
- Any other cause not a result of a manufacturing defect in the shingles.

Mold and mildew are functions of environmental conditions and are not manufacturing defects. As such, mold and mildew are not covered by this Limited Warranty or any implied warranty.

CertainTeed reserves the right to discontinue or modify any of its products, including the color of its shingles, and shall not be liable as a result of such discontinuance or modification, nor shall CertainTeed be liable in the event replacement material varies in color in comparison to the original product as a result of normal weathering. If CertainTeed replaces any material under this warranty, it may substitute products designated by CertainTeed to be of comparable quality or price range in the event the product initially installed has been discontinued or modified.

Inadequately Ventilated and Non-Ventilated Decks

Any shingles applied to inadequately ventilated or non-ventilated decks, other than the shingles and deck systems described in the section titled "Insulated Decks and Radiant Barriers," are subject to a reduced limited warranty period of ten (10) years and do not qualify for SureStart Protection. SureStart™ Protection and the Warranty Period applicable to the shingle are available if CertainTeed determines that the shingle damage was caused exclusively by a manufacturing defect that is unrelated to the inadequate roof system ventilation.

Insulated Decks and Radiant Barriers

CertainTeed's Limited Warranty, including SureStart Protection, will remain in force when its fiberglass shingles are applied to roof deck assemblies where foam insulation is prefabricated into the roof deck system (often called "nailboard insulation"), where insulation is installed beneath an acceptable roof deck system, or where radiant barriers are installed, with or without ventilation, directly below the deck. Acceptable roof deck surfaces must consist of at least 3/8" thick plywood or 7/16" thick Oriented Strand Board (OSB) and slopes must be 2:12 or greater. If a different deck surface material will be utilized, please contact CertainTeed's Technical Services Department for assistance. (See the following important restrictions.)

The design professional is responsible for ensuring: 1) the proper quality and application of the insulation and/or radiant barrier, 2) the provision of adequate structural ventilation and/or vapor retarders as determined to be necessary, and 3) that all local codes are met (particularly taking into account local climate conditions). Special attention must be taken if cellular foam, fiberglass, cellulose insulation or other highly permeable insulation will be used in an unventilated system, or if the insulation/rafter or insulation/joist planes may create an air leak that could lead to moisture transmission and condensation problems. All these important factors and decisions, while not the responsibility of CertainTeed, are critical to assure proper deck system performance.

Ventilated Nail-Base Roof Insulation

Ventilated Nail-Base Roof Insulation products (e.g. FlintBoard® CV) are made of rigid insulation (typically foam board) and another layer of material that provides air space above the insulation and below the nailable deck (which is typically at least 7/16" thick OSB or 3/8" thick plywood). These products can provide soffit-to-ridge ventilation, and if installed in accordance with the deck manufacturer's instructions to achieve sufficient ventilation, will not reduce the scope or length of CertainTeed's Limited Warranty coverage.

Limited Algae-Resistant Warranty

Blue-green algae or gloeocapsa magma, (which has a black/brown appearance and is commonly but incorrectly called "fungus"), can create unsightly streaking on shingles. CertainTeed warrants that the Algae-Resistant (AR) versions of the products in Table 1 will remain free from blue-green algae growth (but not mold or mildew growth) which adversely affects the overall appearance of said shingles for a period of ten (10) or fifteen (15) years, as noted in Table 1.

If during the Algae-Resistant Warranty Period specified in Table 1, the overall appearance of the Algae-Resistant shingles is adversely affected by blue-green algae, CertainTeed will pay the reasonable cost to replace or clean at its option, any affected shingles. In the event of replacement or cleaning, for

the remainder of the Algae-Resistant Warranty Period, CertainTeed's maximum contribution towards subsequent replacement or cleaning will be calculated using the Algae-Resistant Warranty Period specified in Table 1, less a prorated adjustment that reflects the number of months that have elapsed from the start of the Algae-Resistant Warranty Period to the date of reoccurrence.

WARNING: FOR LOW-VOLUME RAIN AND SALT FOG AREAS

In areas of low-volume rain (e.g. areas that receive insignificant rainfall during a 90-day period) and/or "salt fog" (e.g. parts of the Southern California coastline), copper released by algae-resistant (AR) granules or shingles can react with aluminum in gutters and cause severe corrosion of the gutters. In such regions, CertainTeed strongly recommends that vinyl or copper gutters, not aluminum gutters, be used with algae-resistant shingles. CertainTeed disclaims all liability and responsibility for any damages that may result from the use of its algae-resistant shingle products with copper granules where gutters containing aluminum are used.

Limited Wind Warranty

CertainTeed warrants its shingles will resist blow-off damage due to wind velocities, including gusts, up to the maximum wind velocity per the Wind Warranty MPH specified in Table 1 during the first fifteen (15) years of the warranty for Lifetime products and during the first five (5) years for all other products listed in Table 1.

CertainTeed's obligations and liability for shingle blow-off damage during the wind warranty periods as specified above are limited as follows:

- If shingles or hip/ridge accessories blow off because the self-sealing asphalt strips did not activate, CertainTeed will furnish replacement shingles without charge, but only for damaged or blown off shingles.
- If shingles or hip/ridge accessories blow off before the self-sealing asphalt strips could have reasonably activated due to installation in cold weather, CertainTeed will furnish replacement shingles without charge, but only for damaged or blown off shingles. CertainTeed will not be responsible for or reimburse labor costs, roof tear-off, metal work, flashing and disposal expenses, or any other costs pertaining to removal or replacement of damaged shingles. Any costs in excess of CertainTeed's material contribution are the property owner's responsibility (and may be covered by owner's insurance).
- CertainTeed shall have no liability for any shingles not fastened in accordance with CertainTeed installation instructions published at the time of original installation.
- CertainTeed shall have no liability for any damage to persons or property caused by blown off shingles.
- CertainTeed's maximum liability during the Limited Wind Warranty period is the reasonable cost of hand sealing all of the shingles on the roof.

Residential Low-Slope Roofing

For residential low-slope roofing projects less than 2,000 square feet (20 squares), CertainTeed offers limited warranty coverage on our Flintlastic® SA self-adhered roof system provided the products are applied in accordance with CertainTeed's current installation instructions published at the time of installation as follows:

- A 10-year warranty duration on a single ply of Flintlastic SA Cap sheet over a primed plywood roof deck.
- A 12-year warranty duration for a two-ply system consisting of a Flintlastic SA NailBase and a Flintlastic SA Cap sheet.
- A 15-year warranty duration for a three-ply system consisting of a Flintlastic SA NailBase and a Flintlastic SA PlyBase and a Flintlastic SA Cap sheet*.
- A 20-year warranty duration for a three-ply system consisting of a Flintlastic SA NailBase and a Flintlastic SA MidPly and a Flintlastic SA Cap sheet*.

CertainTeed warrants the roof membrane, subject to the following terms, conditions, limitations, and exclusions, for the duration specified above from the date of completion of the roof membrane installation. If during the duration of this Limited Warranty, a manufacturing defect in the roof membrane causes a leak, CertainTeed or its designated roofing contractor will, at CertainTeed's sole discretion, repair or replace the roof membrane materials only as necessary to restore it to a watertight condition.

**Two-ply, direct adhesion to a primed wood deck, without the inclusion of the Flintlastic SA NailBase is permitted; direct adhesion to wood is not permitted by code in Miami-Dade County (check your local building code); direct adhesion to wood plank decks constructed of resinous woods, such as pine, is prohibited; at the end of the roofing membrane's life, roofing membranes self-adhered over wood decks will require replacement of the deck.*

Only manufacturing defects in the roof membrane that cause leaks are covered by this Limited Warranty. CertainTeed's MAXIMUM LIABILITY during the first year of this warranty is the original cost of the CertainTeed membrane materials only. After the first year, CertainTeed's maximum liability is the original cost of the CertainTeed membrane materials used on the roof reduced by 8.3% for 12-year warranty, 10% for 10-year warranty, 6.6% for 15-year warranty and 5% for 20-year warranty during each subsequent year, less any costs previously incurred by CertainTeed for repair or replacements.

Roof components which are not part of the roof membrane and hence not covered by this Limited Warranty include, but are not limited to, the following: underlying roof deck, insulation, vapor retarders, fasteners, metal work, drains, pitch pans, expansion joints, skylights, vents, plastic accessories, any flashing, decorative or reflective coating, surfacing and/or any aggregates. In no event, however, will CertainTeed be responsible for any costs related to the removal or abatement of any asbestos present in any existing roof system to which the CertainTeed roof membrane is applied.

What the Customer Must Do

If you believe your shingles have a manufacturing defect, you must notify CertainTeed within 30 days of discovery and provide proof of property ownership and the date of shingle purchase and application. Without original or sufficient proof of purchase CertainTeed reserves the right to use the shingle manufacturing date for claim calculation. In order to properly evaluate and process a warranty claim, CertainTeed may require the property owner to submit a shingle sample to CertainTeed for analysis and/or permit a CertainTeed representative to make repairs to, take photographs of, and/or take samples from the roof, if required. CertainTeed will evaluate each properly reported claim and will repair, replace, clean or reimburse the property owner for the shingles it determines are defective, in accordance with the terms of this Limited Warranty within a reasonable amount of time. For more details about submitting a warranty claim, visit ctroof.com or call (800) 345-1145.

Please send all notifications and correspondence to:

CertainTeed LLC, 200 Commerce Drive P.O. Box 1000 Montgomeryville, PA 18936.

Attn: CertainTeed Roofing Technical Services Department. Telephone number: 800-345-1145.

Email: rpg.t.services@saint-gobain.com

Warranty Registration (not required)

You may register your product warranty on CertainTeed's website: certainteed.com/warrantyreg. Each registrant receives a registration confirmation number by return e-mail that can be printed and kept with this Limited Warranty and your proof of purchase. If you do not have internet access, you can register your shingles by sending: (1) your name, address, and telephone number; (2) the name and contact information of the contractor who installed your shingles and the original date of installation; and, (3) the type, color and number of squares of your shingles to: **CertainTeed LLC, 20 Moores Road, Malvern, PA 19355, Attn: CertainTeed Roofing Technical Services Department.**

CertainTeed will register your information and mail you a confirmation number. Failure to register this warranty does NOT void the warranty or any of its terms.

For Your Records

Product Purchased: _____ Date of Installation: _____

Roofing Contractor: _____ Contractor's Telephone No. _____

This warranty applies to shingles installed during the calendar year of 2022.

(The warranty in effect at the time the material is originally installed is the applicable warranty.)

Exclusive Warranty and Limitation of Remedies

THIS DOCUMENT CONSTITUTES THE EXCLUSIVE WARRANTIES AND REMEDIES PROVIDED BY CERTAINTEED. THE WARRANTIES AND REMEDIES CONTAINED IN THIS DOCUMENT ARE EXPRESSLY IN LIEU OF ANY AND ALL OTHER OBLIGATIONS, GUARANTEES, WARRANTIES AND REPRESENTATIONS, WHETHER WRITTEN, ORAL OR IMPLIED BY STATUTE, AT LAW OR IN EQUITY, INCLUDING WITHOUT LIMITATION, THE IMPLIED WARRANTIES OF MERCHANTABILITY AND FITNESS FOR A PARTICULAR PURPOSE. SOME STATES OR PROVINCES MAY NOT ALLOW THE EXCLUSION OF IMPLIED WARRANTIES OR MAY DETERMINE THE PERIOD OF TIME FOLLOWING THE SALE THAT A PURCHASER MAY SEEK A REMEDY UNDER IMPLIED WARRANTIES, SO THE ABOVE EXCLUSION MAY NOT APPLY TO YOU.

CERTAINTEED'S OBLIGATIONS, RESPONSIBILITIES, AND LIABILITY SHALL BE LIMITED TO REPAIRING OR REPLACING THE DEFECTIVE PRODUCT OR CLEANING ALGAE-RESISTANT SHINGLES IN THE CASE OF ALGAE GROWTH AS SET FORTH IN THIS LIMITED WARRANTY. IN NO EVENT SHALL CERTAINTEED BE LIABLE FOR ANY SPECIAL, INDIRECT, INCIDENTAL OR CONSEQUENTIAL DAMAGES OF ANY KIND, INCLUDING ANY DAMAGE TO THE PROPERTY, THE BUILDING OR ITS CONTENTS, OR FOR INJURY TO ANY PERSONS, THAT MAY OCCUR AS A RESULT OF THE USE OF CERTAINTEED'S PRODUCTS OR AS A RESULT OF THE BREACH OF THIS WARRANTY. IF YOUR STATE OR PROVINCE DOES NOT ALLOW EXCLUSIONS OR LIMITATIONS OF SPECIAL, INDIRECT, INCIDENTAL OR CONSEQUENTIAL DAMAGES, THE ABOVE LIMITATIONS MAY NOT APPLY TO YOU. IN NO EVENT SHALL CERTAINTEED'S TOTAL LIABILITY ARISING OUT OF OR RELATED TO THE PRODUCT(S) OR THIS LIMITED WARRANTY EXCEED THE REASONABLE COST OF SHINGLES AND LABOR TO REPLACE OR REPAIR THE DEFECTIVE SHINGLES.

This Limited Warranty may not be modified, altered or expanded by anyone, including product distributors, dealers, sellers and/or CertainTeed field representatives.

This Limited Warranty gives you specific legal rights, and you may also have other rights which vary from State to State, or Province to Province.

Roofing Plants and Regional Sales Office

CertainTeed roofing products are sold by CertainTeed Roofing in nine sales regions. They are manufactured in ten residential roofing plants and one commercial roofing plant. Since the early 1900s, CertainTeed has been an innovator in the building materials industry and today is a leading manufacturer of building materials including residential and commercial roofing, vinyl siding, composite decking and railing, fiber glass insulation and vinyl fence products. The company is headquartered in Malvern, Pennsylvania, and employs more than 7,000 employees at approximately 60 manufacturing facilities throughout North America. Continuing the 100-year commitment of "Quality made certain, Satisfaction guaranteed™," CertainTeed remains one of the most trusted names in the industry. More information is available at certainteed.com.

This document is also available in Spanish and French.

Call 1-800-782-8777 or go to www.certainteed.com.

Se puede obtener este documento en español. Favor de llamar 1-800-782-8777.

Ce document est disponible en anglais et en espagnol. Composez le 1-800-782-8777.



CertainTeed

CEILING • DECKING • FENCE • GYPSUM

INSULATION • RAILING • ROOFING • SIDING • TRIM

20 Moores Road, Malvern, PA 19355

Professional: 800-233-8990 Consumer: 800-782-8777

certainteed.com